

45-48	6
30-44	1
DOOR OPNG.	T

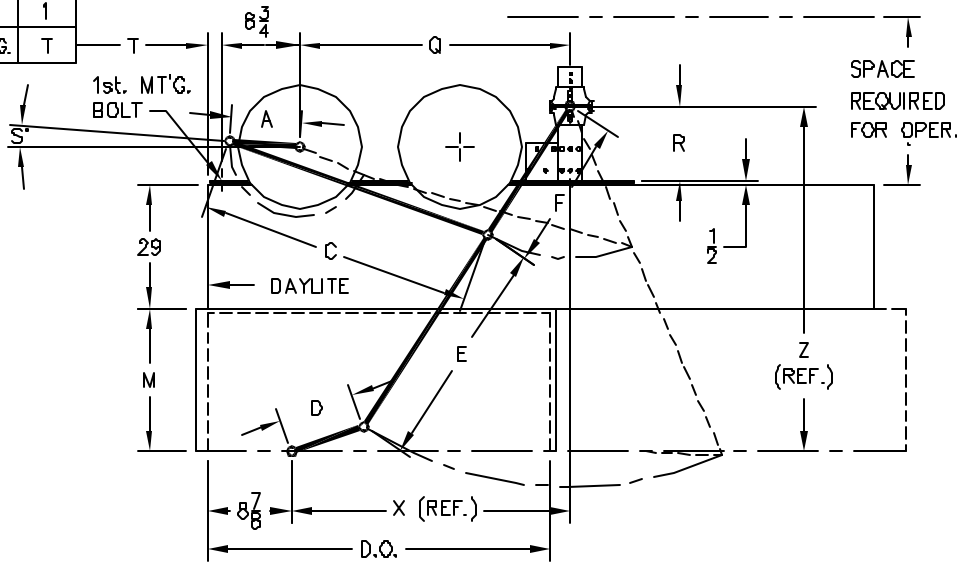

MOVFR	15
MOCT MOD	
MOM-MOH	19
MOMCT MOHCT	

48	7 3/4	34 1/2	12	45	21	23	39 5/8	63 3/4	33 1/2	11 1/4	5'
47	7 5/8	34 3/8	12	45	21	23	39 5/8	63 3/4	33 1/2	11 1/4	5'
46	7 1/2	34 1/4	12	45	21	23	39 5/8	63 3/4	33 3/4	11 1/4	5'
45	7 3/8	34 1/8	12	45	21	23	39 5/8	63 3/4	33 1/2	11 1/4	5'
44	7 3/4	36 1/4	10	37	21	19	34 5/8	55 7/8	33 1/2	7 3/8	12'
43	7 5/8	36 1/8	10	37	21	19	34 5/8	55 7/8	33 1/2	7 3/8	12'
42	7 1/2	36	10	37	21	19	34 5/8	55 7/8	33 1/2	7 3/8	12'
41	7 3/8	35 7/8	10	37	21	19	34 5/8	55 7/8	33 1/2	7 3/8	12'
40	7 1/4	35 3/4	10	37	21	19	34 5/8	55 7/8	33 1/2	7 3/8	12'
39	6 3/8	30 3/8	8	36	18	15	29 1/4	52 1/2	28 3/8	8	10'
38	6 1/4	30 1/4	8	36	18	15	29 1/4	52 1/2	28 3/8	8	10'
37	6 1/8	30 1/8	8	36	18	15	29 1/4	52 1/2	28 3/8	8	10'
36	6	30	8	36	18	15	29 1/4	52 1/2	28 3/8	8	10'
35	5 7/8	29 7/8	8	36	18	15	29 1/4	52 1/2	28 3/8	8	10'
34	5 1/4	26	6	38	17	15	25 1/4	53 1/2	24 3/8	9	10'
33	5 1/8	25 7/8	6	38	17	15	25 1/4	53 1/2	24 3/8	9	10'
32	5	25 3/4	6	38	17	15	25 1/4	53 1/2	24 3/8	9	10'
31	4 3/4	25	6	38	17	15	24 3/8	53 3/4	23 1/2	9 1/4	10'
30	4 5/8	24 7/8	6	38	17	15	24 3/8	53 3/4	23 1/2	9 1/4	10'
INCHES	A	C	D	E	F	M	X	Z	Q	R	S

DOOR OPENING	OPERATOR ARMS	DOOR ARMS	CLUTCH	PIVOT	OPERATOR
--------------	---------------	-----------	--------	-------	----------



SINGLE SPEED & TWO SPEED OPERATOR DATA TABLE
30-48 D.O. FOR HIGH CABS 29" HEADER

FEB. 23 1987
S6898-29