

COMBIVERT F5



ELEVATOR DRIVE

Version 1.72

00.F5.LUB-K172
REV 1D -09/2015



This instruction manual describes the COMBIVERT F5 ELEVATOR DRIVE. Before working with the unit the user must become familiar with it. This especially applies to the knowledge and observance of the following safety and warning indications. The icons used in this instruction manual have the following meaning:



Danger
Discharge Time
Caution



Pay Attention
Important
Warning



Information
Help
Tip

The QR codes used in this instruction manual are linked to the KEB America Youtube Channel. Video examples of general start-up procedures will be linked to QR codes in this instruction manual.

Scan the QR code with the QR code reader on your smart phone to access videos. For your phone to be able to read QR codes you will need to download a QR code scanning app from your mobile app store.



KEB America Youtube Channel URL: <http://qrs.ly/vq4hd9q>

1. General	9	4.4 Changing Parameter Values	54
1.1 Product description	9	4.5 Parameter Structure	54
1.2 Summary of Changes	10	4.6 Saving Parameter Values	55
1.2.1 Functions	10	4.7 Error Messages	55
1.2.2 Parameters	10	5. Initial Start-up	56
1.3 Model number information	11	5.1 Selecting The Configuration	56
1.4 Mounting instructions	12	5.2 Loading The Configuration	56
1.4.1 Classification	12	5.3 Setting The Control Type	57
1.4.2 Physical Mounting	12	5.4 Entering The Operating Data	57
1.4.3 Harsh Environments	12	5.5 Induction Motors	57
1.5 Electrical connections	13	5.5.1 Motor Overload	57
1.5.1 Safety First	13	5.5.2 Induction Motor Data	58
1.5.2 Voltage Supply	13	5.5.3 Auto-Tuning Induction Motors	58
1.5.3 Disconnect switch	14	5.6 PM Synchronous Motors	60
1.5.4 Fusing	14	5.6.1 Motor Overload	60
1.5.5 Line Chokes	15	5.6.2 Motor Data	60
1.5.6 Motor Thermal Protection	16	5.6.3 Auto-Tuning PM motors	61
1.5.7 Motor Cable Length	16	5.7 Machine Data	62
1.5.8 High Voltage Connections	17	5.8 Encoder Feedback	63
1.5.9 Ground Connections	17	5.8.1 Encoder card verification	63
2. Technical Data	18	5.8.2 Encoder serial com. verification	63
1.5.10 High Frequency Shielding	18	5.8.3 Other encoder adjustments	64
1.5.11 Storage of the Unit	19	5.9 Controller Settings	64
2.1 Technical data 230V (size 13 to 21)	20	5.10 Speed and Profile Settings	65
2.2 Technical data 460V (Size 13 to 19)	22	5.11 Running the Motor	65
2.2 Technical Data 460V (Size 20 to 26)	24	5.11.1 Stationary Pole Identification (SPI)	65
2.3 Dimensions and weight	25	5.11.2 Absolute Encoder Setup (no ropes)	67
2.4 Summary of the power circuit terminals	26	5.11.3 Absolute Encoder Setup (with ropes)	69
2.5 Connection of the power circuit	27	5.11.4 Absolute Encoder Position Verification	71
2.6 Time dependent overload curve	29	5.11.5 Encoder Synchronization	72
2.7 Low Speed Overload	30	5.12 High Speed Tuning	73
3.0 Installation and Connection	31	5.12.1 System Inertia Learn	73
3.1 Control Circuit	31	5.12.2 Feed Forward Torque Control, FFTC	74
3.1.1 Terminal Strip Connections	31	5.12.3 Speed Gain Adjustment	75
3.1.2 Connection of the control signals	32	5.12.4 Synthetic Pre-Torque	79
3.1.3 Digital Inputs	32	6. Parameter Description	81
3.1.4 Analog Inputs	32	6.1 US-Parameters	81
3.1.5 Voltage Input / External Power Supply	33	Password	81
3.1.6 Digital Outputs	33	Load defaults	81
3.1.7 Relay Outputs	33	Load configuration	81
3.1.8 Analog Outputs	33	Select configuration	81
3.1.9 Voltage Output	33	Other US parameters	82
3.2 Encoder Connections	34	6.2 LF-Elevator Parameters	83
3.2.1 X3A RS422/TTL Incremental Encoder Input	34	Signal / operating mode	83
3.2.2 X3A TTL Inc. Enc. In Screw Terminals	36	Drive configuration	88
3.2.3 X3A Hiperface Encoder	38	Selected motor	89
3.2.4 X3A EnDat Encoder	42	Drive fault auto reset	89
3.2.5 X3A SIN/COS-SSI Encoder	46	Electronic motor overload protection	90
3.2.6 X3B Incremental Encoder Output	50	Electronic motor overload current	91
4. Operation of the unit	52	Rated motor power	92
4.1 Digital Operator	52	Rated motor speed	92
4.2 Parameter Identification	53	Rated motor speed	93
4.3 Parameter Selection	53	Rated motor current	93
		Rated motor frequency	93
		Rated motor voltage	94
		Power factor	94
		Field weakening speed	95
		Rated motor torque	96
		PM motor resistance	97
		PM motor inductance	97
		Contract speed	98

Table of Contents

Traction sheave diameter.....	98	Set speed	132
Gear reduction ratio	98	Command speed	132
Roping ratio	99	Actual output frequency	132
Load weight.....	99	Actual speed value.....	132
Estimated gear reduction	99	Encoder 1 speed.....	132
Encoder interface	100	Encoder 2 speed.....	132
Encoder pulse number.....	104	Commanded torque.....	133
Encoder channel swap / direction.....	104	Actual torque.....	133
Encoder sample time	105	Actual load	133
Control Mode	106	Peak load.....	133
Kp speed accel.	107	Phase current.....	133
Kp speed decel.	107	Peak current.....	133
Kp speed synthetic pretorque	107	Torque current	133
Ki speed accel.....	107	DC bus voltage	133
Ki speed decel.	107	Peak DC bus voltage	133
Ki speed synthetic pretorque	107	Output voltage	134
Ki speed	108	Input terminal state	134
offset accel.....	108	Input terminal state	134
Ki speed	108	Output terminal state	134
offset decel.....	108	Output flag state	135
Maximum torque.....	108	Output status	135
Max. torque emergency oper.	109	Active parameter set	135
Open loop torque boost.....	110	Analog pattern raw	135
Switching frequency	110	Analog pattern processed	135
Leveling speed, S.....	111	Analog pre-torque raw	136
High speed, S.....	111	Analog pre-torque processed.....	136
Inspection speed, S.....	111	Analog option raw	136
High leveling Speed	111	Analog option processed	136
Intermediate Speed 1	112	Analog Out 1 preamp	136
Intermediate Speed 2	112	Analog Out 1 post-amp.....	136
Intermediate Speed 3	112	Analog Out 2 preamp	136
Starting jerk	113	Analog Out 2 post-amp.....	136
Acceleration	113	Motor pot.....	137
Acceleration jerk.....	114	value	137
Deceleration jerk.....	114	Power module temperature.....	137
Deceleration	114	Overload counter.....	137
Approach jerk	114	Power on counter	137
Stop jerk	114	Run counter	137
Recommended Profile Settings.....	117	Modulation grade.....	137
Speed following error.....	118	Timer 1.....	137
Speed difference.....	118	Timer 1.....	137
Following error timer.....	118	Actual switching frequency	137
Emergency operation mode	119	Motor temperature	138
Emergency Terminal Slowdown Speed	119	Position counter	138
External Load Weigher	120	Active Motor Power	138
Pre-torque gain	120	Peak Motor Speed	138
External Load Weigher Pre-torque offset	120	Magnetizing Current.....	138
External Load Weigher Pre-torque direction	120	8.0 Advanced Adjustments	139
Speed Start Delay.....	121	E.OL2 function.....	139
Brake Release Delay.....	121	Synthetic Pre-torque Brake Release Timer.....	140
Encoder resolution multiplier.....	122	Synthetic Pre-torque Hold Timer.....	140
Absolute encoder position	122	Max. speed for max. KI.....	141
Brake engage time.....	123	Speed for min KI.....	141
Current hold time.....	123	Speed dependent KP gain	142
Software version.....	124	Min KP gain at high speed.....	142
Software date	124	KD speed gain	142
X2A Input state	125	Phase current check	143
X2A Output state	127	Analog input noise clamp.....	143
Operation phase.....	127	HSP5 Watchdog time.....	143
Inverter load	128	E.dOH function	143
Motor command speed	128	Analog pattern gain	144
Actual motor speed.....	128	Reference splitting	144
Actual elevator speed.....	128	Serial Com. Baud Rate	144
Phase current.....	129	Function Test.....	144
Peak phase current	129	Encoder 2	144
Actual DC voltage	129	Output PPR	144
Peak DC voltage	129	Analog Output 2 Configuration	145
Actual output frequency	129		
Last fault	129		
Inverter status	131		
7.0 Run Parameters	132		
Inverter state	132		

9.0 Input/Output Configuration	146
9.1 Digital Input Parameters	146
Input Type.....	146
Noise Filter.....	146
9.2 Digital Output Parameters	147
Output Inversion.....	147
Output X2A.18.....	147
Output X2A.19.....	147
Output X2A.24..26.....	147
Output X2A.27..29.....	147
9.3 Timing Graph - Analog Control.....	149
9.4 Timing Graph - Digital Control.....	151
10.1 Elevator Drive Data	154
Field weakening.....	154
corner	154
Field weakening.....	154
curve.....	154
Stator resistance	155
Sigma inductance.....	155
Rotor resistance	155
Magnetizing inductance.....	155
Motor control	155
Vmax regulation.....	156
KP current	156
KI current.....	156
Acceleration torque	156
System inertia	156
FFTC filter.....	156
FFTC gain.....	156
Torque command filter	156
11.0 Position Control.....	157
11.1 One Floor Position Control.....	157
One floor positioning	157
Learning the slow down distance.....	159
Min. slowdown dist.....	160
Slowdown distance	160
Correction distance.....	160
Current position.....	162
Scaling increments high.....	162
Scaling increments low.....	162
Scaling distance	162
12.1 Operation Problems.....	163
12.2 Diagnostic Solutions	170
12.3 Drive Faults	174
A.1 Parameter List Reference	190
A.2 Customer Parameter Values.....	194





Danger to Life

AC motor controls and servo drives contain dangerous voltages which can cause death or serious injury. During operation they can have live "energized" un-insulated parts, moving parts, as well as hot surfaces. Care should be taken to ensure correct and safe operation in order to minimize risk to personnel and equipment.



Only Qualified Personnel

All work involving this product, installation, start up as well as maintenance may only be performed by qualified electrical technical personnel. According to this manual "qualified" means: those who are able to recognize and acknowledge the possible dangerous conditions based on their training and experience and those who are familiar with the relevant standards and installation codes as well as the field of power transmission.



Protect Against Accidental Contact

AC motor controls and servo drives must be protected against physical damage during transport, installation, and use. Components or covers must not be bent or deformed as this may decrease insulation distances inside the unit resulting in an unsafe condition. On receipt of the unit visual damage should be reported immediately to the supplier. **DO NOT ATTEMPT TO POWER UP A UNIT WITH VISIBLE PHYSICAL DAMAGE.** This unit contains electrostatically sensitive components which can be destroyed by incorrect handling. For that reason, disassembly of the unit or contact with the components should be avoided.



Note Capacitor Discharge Time

Before any installation and connection work can be done, the supply voltage must be turned off and locked out. After turning off the supply voltage, dangerous voltages may still be present within the unit as the bus capacitors discharge. Therefore it is necessary to wait 5 minutes before working on the unit after turning off the supply voltage.



Secure Isolation

The low voltage control terminal strip and communication ports are securely isolated in accordance with EN50178. When connecting to other systems, it is necessary to verify the insulation ratings of these systems in order to ensure the EN requirements are still met. When connecting the unit to a grounded delta power system, the control circuit can no longer be classified as a "securely isolated circuit".

Before putting the motor control into operation be sure the connection terminals are tight and all covers removed for installation have been replaced.



Damage to Property and Injury to Persons

The AC motor control or servo system can be adjusted to self initiate an automatic restart in the event of a fault or error condition. The design of the system must take this into account, such that personnel are safeguarded against potentially dangerous circumstances.



Redundant Safety Mechanisms

Software functions in the AC motor control or servo system can be used to control or regulate external systems. However, in the event of failure of the motor control or servo system there is no guarantee these software function(s) will continue to provide the desired level of control. As a result, when operator or machine safety is at stake, external elements must be used to supplement or override the software function within the AC motor control or servo system.



1. General

1.1 Product description

In selecting the COMBIVERT F5 series inverter, you have chosen a frequency inverter with the highest quality and dynamic performance.

The F5 inverter has the following features:

- small mounting footprint
- large die IGBTs
- power circuit gives low switching losses
- low motor noise with high carrier frequency
- extensive protection for over- current, voltage and temperature
- voltage and current monitoring in static and dynamic operation
- short circuit proof and ground-fault proof
- noise immunity in accordance with IEC1000
- hardware current regulation
- integrated temperature controlled cooling fan
- PM motor control capable
- Synthesized-pre torque for roll back compensation
- CE compliant and cULus listed
- extensive functional capabilities
- DPC - Direct Position Control
- Stationary Pole Identification

This manual describes the frequency inverter COMBIVERT F5.

- 10 hp...60 hp 270A peak / 230V class
- 10 hp...175 hp 450A peak / 480V class

CPU Software version 4.2 or greater
Application Software Version 1.72



It is exclusively designed for smooth speed regulation of a three-phase motor.

The operation of other electrical loads is forbidden and can lead to destruction of the unit.



1.2 Summary of Changes

1.2.1 Functions

The following functions are new. Each will be described in more detail on the following pages.

RUN / STOP - LF.3 = RUN or STOP with serial communication

Static Pole Identification - LF.3 = SPI

Inertia Learn - LF.3 = I Lrn

External Load Weighing Pretorque - LF.30=3 configured without US.17, US.18, P.LF.31, P.LF.32

1.2.2 Parameters

New Parameters

The following parameters are new to software version 1.72. Each will be described in more detail on the following pages.

US.37 Test Function

Ld.29 Acceleration Torque

P.LF.31 Proportional Pre-torque Gain

P.LF.32 Integral Pre-torque Gain

Deleted Parameters

The following parameters have been deleted from the parameter list. Their function is either no longer required or has been moved to another parameter.

US.19 Field Weakening Corner Speed - use Ld.18 same function

US.31 Proportional Pre-torque Gain - use P.LF.31 same function

US.32 Integral Pre-torque Gain - use P.LF.32 same function

LF.34 Proportional Current Gain - use Ld.27 same function

LF.35 Integral Current Gain - use Ld.28 same function

3.LF.26 Write Data from or to encoder

1.3 Model number information

Part Number

15.F5.A1G-RL02

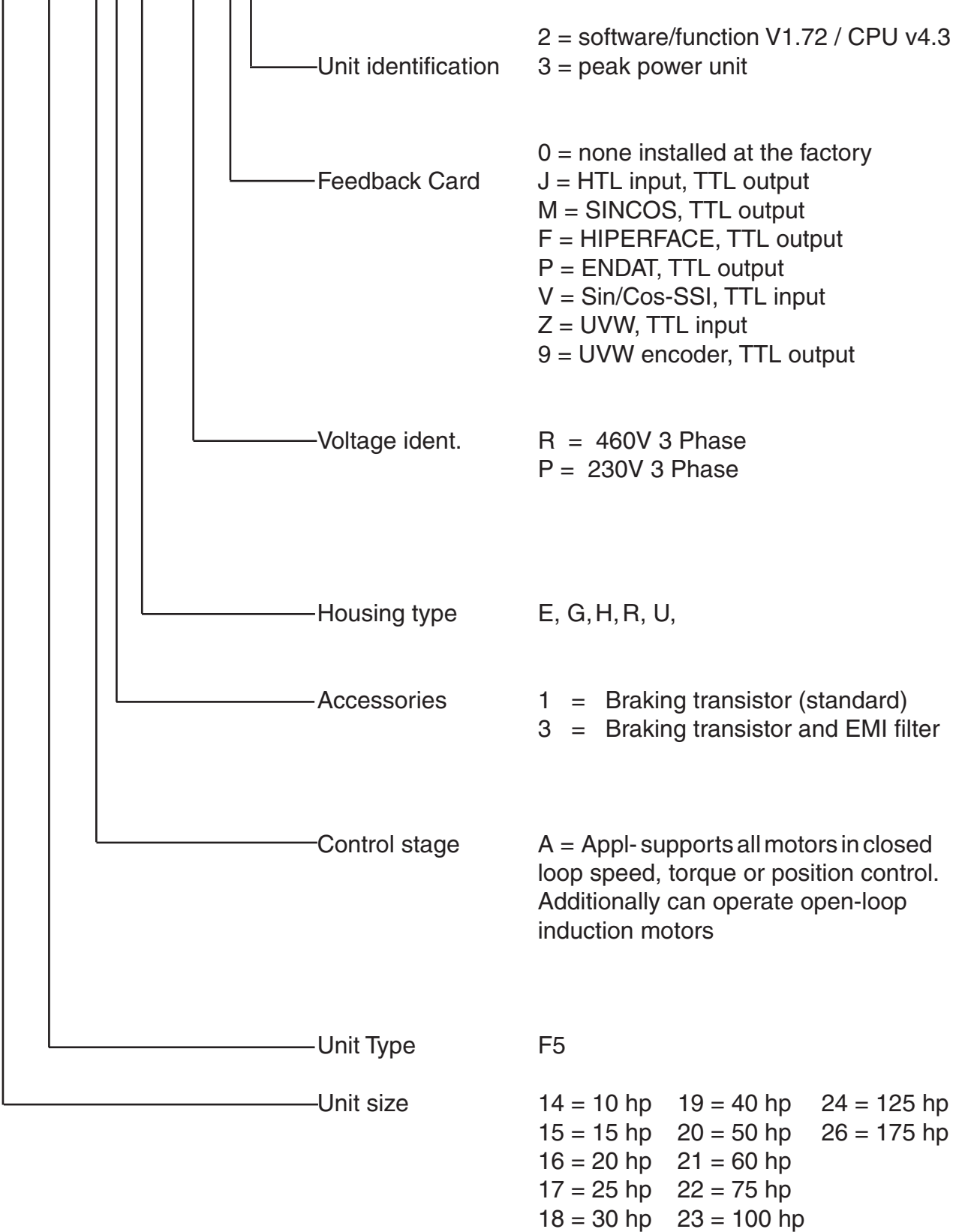

General

1.4 Mounting instructions

1.4.1 Classification



- The elevator drive is classified as an "Open Type" inverter with an IP20 rating and is intended for "use in a pollution degree 2 environment." The unit must be mounted inside of a control cabinet offering proper environmental protection.

1.4.2 Physical Mounting

- Install the inverter in a stationary location offering a firm mounting point with low vibration.
- Installation of the inverter on a moving system may require special earth ground connections to the inverter.
- For best high frequency grounding, install the inverter on a bare metal sub-panel, i.e. zinc plated steel or galvanized steel.
- Take into consideration the minimum clearance distances when positioning the inverter (see drawing below). The F5 series inverters are designed for vertical installation and can be aligned next to each other. Maintain a distance of at least 2 inches in front of the unit. Make sure cooling is sufficient.

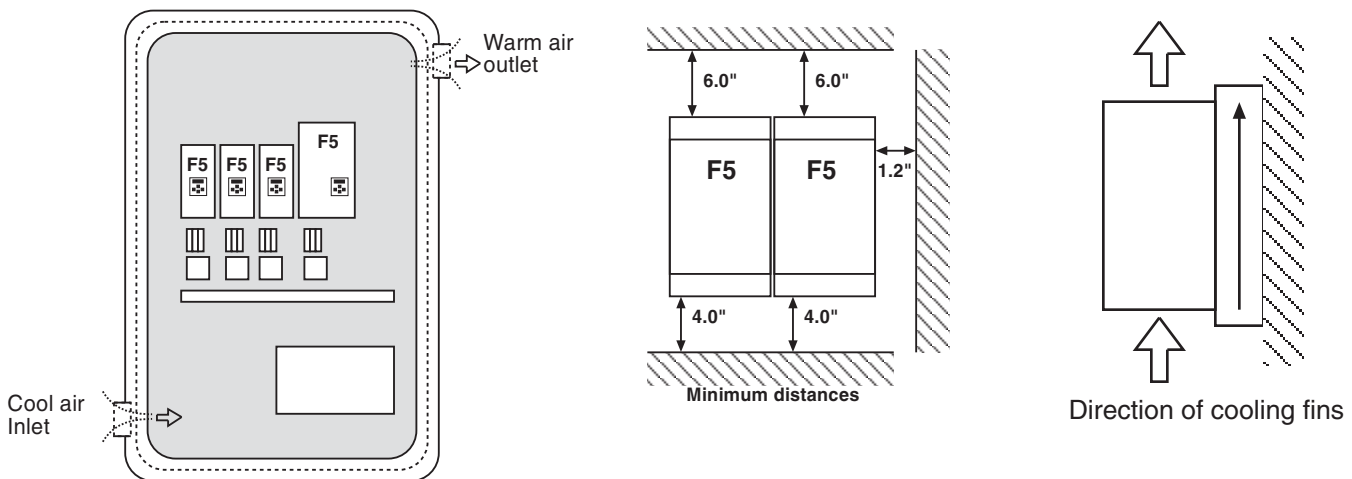

1.4.3 Harsh Environments

- For extended life, prevent dust from getting into the inverter.
- When installing the unit inside a sealed enclosure, make sure the enclosure is sized correctly for proper heat dissipation or that a cooling system has been installed in the panel.
- Protect the inverter against conductive and corrosive gases and liquids. Water or mist should not be allowed into the inverter.
- The F5 elevator drive inverter must be installed in an explosion-proof enclosure when operating in an explosion-proof environment.



1.4.4 Ambient Conditions



- Maximum Surrounding Air Temperature 45°C!** The operating temperature range of the unit is -10°C to +45°C (14°F to +113°F). Operation outside of this temperature range can lead to shut down of the inverter.
- The unit can be stored (power off) in the temperature range -25°C to 70°C (-13°F to +158°F).
- The power rating of the inverter must be derated for operation above 3,300 ft (1000 m). Reduce the rated power 1% for each additional 330 ft (100 m). The maximum elevation for operation is 6,560 ft (2000 m).
- The relative humidity shall be limited to 95% without condensation.

1.5 Electrical connections

1.5.1 Safety First



- CAUTION - RISK OF ELECTRIC SHOCK!** Always disconnect supply voltage before servicing the F5 Elevator Drive.
- After disconnecting the supply voltage, always wait 5 minutes before attempting to change the wiring. The internal DC BUS capacitors must discharge.

1.5.2 Voltage Supply

- Pay attention to the supply voltage and be sure the supply voltage matches that of the inverter. A 230V unit can be supplied with voltage in the range 180 to 260VAC +/-0%, for a 460V unit the range is 305 to 500VAC +/- 0%, 48Hz to 62 Hz.
- All 240V models are suitable for use on a circuit capable of delivering not more than ___ kA rms symmetrical amperes, 240 volts maximum when protected by class ___ fuses rated ___ Amperes as specified in table 1.5.4.1 or when protected by a circuit breaker having an interrupt rating not less than ___ kA rms symmetrical amperes, 240V maximum, rated ___ amperes as specified in table 1.5.4.1.
- All 480V models are suitable for use on a circuit capable of delivering not more than ___ kA rms symmetrical amperes, 480 volts maximum when protected by class ___ fuses rated ___ Amperes as specified in table 1.5.4.2 or when protected by a circuit breaker having an interrupt rating not less than ___ kA rms symmetrical amperes, 480V maximum, rated ___ amperes as specified in table 1.5.4.2.



- Connection of the F5 series inverters to voltage systems configured as a corner grounded delta, center tap grounded delta, open delta, or ungrounded delta, may defeat the internal noise suppression of the inverter. Increased high frequency disturbance in the controller and on the line may be experienced. A balanced, neutral grounded wye connection is always recommended. The three phase voltage imbalance must be less than 2% phase to phase. Greater imbalance can lead to damage of the inverter's power circuit.

1.5.3 Disconnect switch

- A disconnect switch or contactor should be provided as a means of turning off the supply voltage when the unit is not in use or when it must be serviced.
- Repetitive cycling on and off of the input supply voltage more than once every two minutes can lead to damage of the inverter.

1.5.4 Fusing



- Integral solid state short circuit protection does not provide branch circuit protection. Branch circuit protection must be provided in accordance with the Manufacturer Instructions, National Electrical Code (NFPA70 or CSA22.1) and any additional local codes.



- Branch circuit protection for the F5 must be provided using the fuses as listed in the tables 1.5.4.1 and 1.5.4.2 below. Fast acting class J fuses are recommended. As an example, use BUSSMANN type JKS. **For installations supplied by an isolation transformer and that have harmonic filters installed, a high speed class J fuse must be used** (only Ferraz type HSJ is approved).
- The minimum voltage rating for protection devices used with 230V inverters shall be 250VAC. The minimum voltage rating for protection devices used with 460V inverters shall be 600VAC.

Table 1.5.4.1 - 230V Units

	SCCR	UL 248	Semiconductor	UL 489
Unit Size / Housing	[kA] rms	Class J Rating [A]	Fuse Number* / Rating [A]	MCCB [A] / Siemens Cat. No.
13 / E	10	40	50 140 06 80 / 80	
14 / G	10	50	50 140 06 100 / 100	
15 / G, H	10, 18	70	50 140 06 80 / 80	
16 / H	18	90	--	
17 / H	18	110	--	
18 / R	100	125	--	150A / DG-frame 3VL 150 UL
19 / R	100	150	--	150A / DG-frame 3VL 150 UL
20 / R	100	175	--	250A / FG-frame 3VL 250 UL
21 / R	100	200	--	250A / FG-frame 3VL 250 UL

* Semiconductor fuses are manufactured by Siba Fuse Inc. When using this type of fuse, this is the model number of the fuse is the fuse that must be used.

Table 1.5.4.2 - 480V Units

	SCCR	UL 248	Semiconductor	UL 489
Unit Size / Housing	[kA] rms	Class J Rating [A]	Fuse Number* / Rating [A]	MCCB [A] / Siemens Cat. No.
13 / E	10	25	50 140 06 40 / 40	
14 / E	10	30	50 140 06 50 / 50	
14 / G	10	30	50 140 06 80 / 80	
15 / E	10	40	50 140 06 80 / 80	
15 / G, H	10, 18	40	50 140 06 40 / 40	
16 / G, H	10, 18	50	50 140 06 63 / 63	
17 / G, H	10, 18	60	50 140 06 80 / 80	
18 / H	18	70	50 140 06 80 / 80	
19 / H	18	90	50 140 06 100 / 100	
19 / R	100	90	--	150A / DG-frame 3VL 150 UL
20 / H	18	100	--	
20 / R	100	100	--	150A / DG-frame 3VL 150 UL
21 / R	100	150	--	150A / DG-frame 3VL 150 UL
22 / R	100	175	--	150A / DG-frame 3VL 150 UL
23 / R,U	100	200	--	250A / FG-frame 3VL 250 UL
24 / R,U	100	225	--	250A / FG-frame 3VL 250 UL
25 / U	100	275	--	400A / JG-frame 3VL 400 UL
26 / U	100	300	--	400A / JG-frame 3VL 400 UL
27 / U	100	350	--	400A / JG-frame 3VL 400 UL
28 / U	100	400	--	400A / JG-frame 3VL 400 UL

* Semiconductor fuses are manufactured by Siba Fuse Inc. When using this type of fuse, this is the model number of the fuse is the fuse that must be used.

- Fuses shall not be installed between the drive and the motor.
- In PM motor applications where the drive input current can be lower than the output current, it is allowed to use a protection device with a lower current rating thus being able to optimize line side wiring and ancillary components.
- If the controller / elevator drive is supplied through an individual isolation transformer, the maximum fuse amp rating shall not be greater than 125% of the secondary current rating of the transformer per NFPA70 and CSA 22.1. This value may be significantly lower than the values in the preceding tables.



1.5.5 Line Chokes

- A line choke with minimum 3% impedance is required for all 230 V inverters 50hp (size 20) and greater. A line choke with minimum 3% impedance is required for all 480V inverters 100hp (size 23) and greater.



- Installation of a line choke is recommended and can be used prevent nuisance errors and protection caused by voltage spikes. Additionally, the use of a line choke will double the operational lifetime of the DC bus capacitors in the unit.

1.5.6 Motor Thermal Protection

- The F5 series inverters are UL approved as a solid state motor overload protection device. It is necessary to adjust the current trip level in parameter LF.9 or LF.12. The function assumes the use of a non-ventilated motor. The function meets the requirements set forth in VDE 0660 Part 104, UL508C section 42, NFPA 70 Article 430 part C. See the description for parameter LF.9 for the trip characteristics.
- A motor winding sensor can also be used for additional safety and the highest level of protection. Either a normally closed contact (rating: 15V / 6mA) or a PTC (positive temperature coefficient) resistor can be connected to the T1, T2 terminals on the inverter. The thermal device should be connected as indicated in Section 2.5.

1.5.7 Motor Cable Length

- In some conventional installations and many MRL applications, the motor can be a considerable distance (greater than 40 feet) from the elevator drive. Under these circumstances the long cable length can cause high voltage peaks or high dv/dt (rate of voltage rise) on the motor windings. Depending on the design of the motor, these can lead to damage of the motor winding. Therefore, in these installations use of a special dv/dt filter is highly recommended.
- The standard approved solution is a special output choke. The choke is designed to be used with a maximum of 16kHz switching frequency and low inductance so it does not drastically influence the motor's equivalent circuit model.
- There are three sizes available for motors rated up to 100A. The part numbers and current ratings are listed below.

<u>Part Number</u>	<u>Rated Current</u>
15Z1F04-1005	22A
17Z1F04-1005	42A
21Z1F04-1005	100A

- The use of a conventional line or motor choke on the output of the drive is not recommend since the inductance value is high enough that it would distort the values in the motor model and result in poor control of the motor.

1.5.8 High Voltage Connections

- Always note inverter voltage, select appropriate over current protection devices, select disconnect device, and select proper wire size before beginning the wiring process. Wire the drive according to NFPA 70 Class 1 requirements.
- The correct wire gauge for each size inverter can be selected from the charts under Section 2.1-2.2 . The wire gauge is based on the maximum fuse rating for the inverter. The terminal tightening torque can be found for each unit in the same charts.
- Always use UL listed and CSA approved wire. Use 60/75°C copper conductors only for equipment rated 100 Amperes or less and use 75°C Copper Conductors only for equipment rated greater than 100 Amperes! Use minimum 300V rated wire with 230V systems and minimum 600V rated wire with 480V systems.
- To prevent coupling high frequency noise, the following wires must be spatially separated from each other a minimum distance of 8 inches (20 cm) when they are laid parallel to each other :
 - AC supply power and motor lines not connected to inverters
 - motor lines connected to inverters
 - control and data lines (low-voltage level < 48 V)
- When using EMI filters, use only the wire provided with the filter to connect the filter to the inverter. Do not add additional wire between the filter and the inverter as this will have a negative effect on the operation of the filter.

1.5.9 Ground Connections

- When working with high frequencies (> 1kHz) and power semiconductors it is recommended to make all ground connections with large exposed metal surfaces in order to minimize the ground resistance.
- The metal sub-plate the inverter is mounted on is regarded as the central ground point for the machine or the equipment. For best results use an unpainted, galvanized or plated sub-panel.
- An additional high frequency ground wire should be connected between the inverter and the sub-panel. Use a stranded wire equal in size to the main line conductor or a thick ground strap. This is in addition to the ground wire required by NFPA 70, UL 508, CSA 22.1
- All ground connections should be kept as short as possible and as close as possible to the ground system, sub-panels.
- If other components in the system exhibit problems due to high frequency disturbances, connect an additional high frequency ground wire between them and the sub-panel.
- The EMI filter should be mounted to the drive or as close as possible to the inverter and on the same sub-panel as the inverter. Good metallic surface contact to the sub-panel is required to provide adequate high frequency grounding of the filter.

2. Technical Data

1.5.10 High Frequency Shielding

- Use of shielded cable is recommended when high frequency emissions or easily disturbed signals are present. Examples are as follows:
 - motor wires: connect shield to ground at both the drive and motor, NOTE the shield should never be used as the protective ground conductor required by NFPA70 or CSA22.1. Always use a separate conductor for this.
 - digital control wires: connect shield to ground at both ends.
 - analog control wires: connect shield to ground only at the inverter.

- The connection of meshed shields to the ground connection should **not** be done through a single strand or drain wire of the shield, but with metallic clamps to provide 360° contact around the surface of the shield to the ground point. Connection with a single wire from the braided shield reduces the effectiveness of the shield 70%. Metal conduit clamps work well for this. Be sure the fit is tight.

- Ridged metal conduit can be used as the shield of the motor wires. Always observe the following points :
 - remove all paint from the control cabinet and motor housing where the conduit is fastened
 - securely fasten all conduit fittings
 - run only the motor wires through the conduit, all other wires, high voltage AC and low voltage signal, should be pulled through a separate conduit.
 - connect the control panel to the Sub-panel with a heavy ground strap.

- If EMI filters are used, they should be mounted to the inverter or as close as possible to the inverter and on the same sub-panel as the inverter. Good metallic surface contact to the sub-panel is required to provide adequate high frequency grounding of the filter. Always use the shielding plate provided with the filter when connecting the filter to the inverter.

- Shielding of control wires:

If digital signal wires are terminated on a terminal block in the control panel, the shields should be firmly connected to the sub-panel on both sides of the terminal block.

The shields of digital signal wires originating outside the control cabinet which are not terminated on a terminal block, must be connected to the sub-panel at the point where the cable enters the control panel and at the inverter.

If the shield is terminated to the sub-panel within 8 inches (20cm) of the inverter, then the shield no longer needs to be connected to the inverter.

When using un-shielded signal wires, they should always be installed as a twisted pair (signal and common).

Low voltage signal wires should cross high voltage wires at right angles.

1.5.11 Storage of the Unit

The DC bus of the KEB F5 Combivert is equipped with electrolytic capacitors. If the electrolytic capacitors are stored de-energized, the oxide film working as dielectric fluid reacts with the acidic electrolyte and destroys itself slowly. This affects the dielectric strength and capacity of the unit. If the capacitors start running with rated voltage again, the oxide film tries to build up quickly. This causes heat and gas and leads to the destruction of the capacitors.

In order to avoid failures, the KEB F5 Combivert must be started up according to the following specification based on duration of storage period (powered off):

Storage Period < 1 Year			
*	Start up normally, without any additional precautions		
Storage Period 1...2 Years			
*	Power on frequency inverter for one hour without modulation		
Storage Period 2...3 Years			
*	Remove all cables from power circuit, including braking resistor and GTR7 connections		
*	Open control release		
*	Connect variable voltage supply to inverter input		
*	Increase voltage slowly to indicated input level and remain at for the specified time.		
	Voltage Class	Input Voltage	Minimum Time
	230V	0...160V	15 min
		160...220V	15 min
		220...260V	1 h
	480V	0...280V	15 min
		280...400V	15 min
		400...500V	1 h
Storage Period > 3 Years			
*	Input voltages same as above, however double the amount of time for each additional year. Eventually consider changing capacitors.		

Technical Data

2.1 Technical data 230V (size 13 to 21)

Inverter Size	13	14		15		16	17	
Recommended Motor Power [hp]	7.5	10		15		20	25	
Housing size	E	E	G	G		H	H	
Unit Hardware	2	2	2	2	3	2	2	3
Input Ratings								
Supply voltage [V]	180...260 ±0 (240 V rated voltage)							
Supply voltage frequency [Hz]	50 / 60 +/- 2							
Input phases	3	3		3		3	3	
Rated input current [A]	28	36		52		63	92	
Recommended wire gauge ¹⁾ [awg]	10	8		8	6	4	3	
Output Ratings								
Rated output power [kVA]	9.5	13		19		26	33	
Rated motor power [kW]	5.5	7.5		11		15	18.5	
Rated output current [A]	22	28		42		57	84	
Peak current (30 seconds) ²⁾ [A]	36	49.5		72	86	118	151	168
Over current fault (E.OC) trip level [A]	43	59		86	104	142	181	201
Output voltage [V]	3 x 0...V input (3 x 0...255V ²⁾)							
Output frequency [Hz]	Generally 0 to 599Hz (limited by control board and carrier frequency)							
Rated switching frequency ³⁾ [kHz]	8	4	16	4	16	16	4	4
Maximum switching frequency [kHz]	16	16	16	8	16	16	16	16
Power loss at rated operation ⁴⁾ [W]	290	350	330	330	430	550	850	850
Stall current at 4kHz [A]	24	33	33	36	53	73	126	118
Stall current at 8kHz [A]	24	24	33	31	53	73	109	97
Stall current at 16kHz [A]	16.8	16.8	33	26	53	73	92	59
Braking Circuit								
Min. braking resistance[Ohm]	16	16	8.0	8.0	5.6	4.5	4.5	
Typ. braking resistance[Ohm]	27	20	20	13	13	10	7.0	
Max. braking current [A]	25	25	50	50	70	90	90	
Installation Information								
Max. shielded motor cable length ⁵⁾ [ft]	330	330		330		330	330	
Tightening torque for power terminals [in lb]	11	11		11	35		35	
Environmental								
Max. heat sink temperature TOH [°C]	90°C / 194°F							
Storage temperature [°C]	-25...70 °C / -13...158°F							
Operating temperature [°C]	-10...45 °C / 14...113°F							
Housing design / protection	Chassis / IP20 / Pollution Degree 2							
Relative humidity	max. 95% without condensation							
Approvals								
Tested in accordance with...	EN 61800-3 /UL508C							
Standards for emitted interference	EN 55011 Class B / EN 55022 Class A							
Standards for noise immunity	IEC 1000-4-2 / -3 / -4 / -5/ -6							
Climatic category	3K3 in accordance with EN 50178							



The recommended motor rating is for 4/6 pole standard motors. When using motors with different numbers of poles, the inverter must be dimensioned based on the motor rated current. Contact the manufacturer for special frequency motors.

The power rating of the inverter must be de-rated for operation above 3,300 ft (1000 m). Reduce the rated power 1% for each additional 330 ft (100 m). The maximum elevation for operation is 6,560 ft (2000 m).

Inverter Size	19	20	21	
Recommended Motor Power [hp]	40	50	60	
Housing size	R	R	R	
Unit Hardware	2	3	2	2
Input Ratings				
Supply voltage [V]	180...260 ±0 (240 V rated voltage)			
Supply voltage frequency [Hz]				
Input phases	3	3	3	3
Rated input current [A]	115	130	143	170
Recommended wire gauge ¹⁾ [awg]	1	2/O	3/O	
Output Ratings				
Rated output power [kVA]	46	59	71	
Rated motor power [kW]	30	37	45	
Rated output current [A]	115	130	154	
Peak current (30 seconds) ²⁾ [A]	172	230	217	270
Over current fault (E.OC) trip level [A]	207	270	315	
Output voltage [V]	3 x 0...V input (3 x 0...255 V ²⁾)			
Output frequency [Hz]	Generally 0 to 599Hz (limited by carrier frequency)			
Rated switching frequency [kHz]	8	8	8	
Maximum switching frequency ³⁾ [kHz]	16	16	16	
Power loss at rated operation ⁴⁾ [W]	1200	1400	1700	
Stall current at 4kHz [A]	123	160	198	
Stall current at 8kHz [A]	115	145	180	
Stall current at 16kHz [A]	70	101	101	
Braking Circuit				
Min. braking resistance[Ohm]	3.9	2.0	2.0	
Typ. braking resistance[Ohm]	4.7	3.9	3.0	
Max. braking current [A]	102	160	160	
Installation Information				
Max. shielded motor cable length ⁵⁾ [ft]	165			
Tightening torque for power terminals [in lb]	53			
Environmental				
Max. heat sink temperature TOH [°C]	90°C / 194°F			
Storage temperature [°C]	-25...70 °C / -13...158°F			
Operating temperature [°C]	-10...45 °C / 14...113°F			
Housing design / protection	Chassis / IP20 / Pollution Degree 2			
Relative humidity	max. 95% without condensation			
Approvals				
Tested in accordance with...	EN 61800-3 /UL508C			
Standards for emitted interference	EN 55011 Class B/EN 55022 Class A			
Standards for noise immunity	IEC 1000-4-2 / -3 / -4 / -5/ -6			
Climatic category	3K3 in accordance with EN 50178			

1) The wire gauge is based on the maximum fuse rating, copper wire with a 75°C insulation rating, THHW or equivalent. If circuit protection is selected based on the actual input current, the wire size could be reduced.

2) This is the peak output current limited by hardware regulation. The software current control reserves 5% for closed loop regulation.

3) This is the maximum carrier frequency the power stage can support. The actual operating carrier frequency is adjusted and limited by the control card.

4) This is the power dissipation at the rated carrier frequency, rated voltage and rated load. Operation at reduced carrier frequencies or reduced load will decrease this value.

5) Max motor cable length when using shielded cable, KEB EMI filter, and the installation must conform to EN55011 / EN55022.

Technical Data

2.2 Technical Data 480V (Size 13 to 19)

Inverter Size	13	14	15	
Recommended Motor Power [hp]	7.5	10	15	
Housing size	E	E	E	G
Unit Hardware	2	2	2	2
Input Ratings				
Supply voltage [V]	305...528 ±0 (480 V Nominal voltage)			
Supply voltage frequency [Hz]	50 / 60 +/- 2			
Input phases	3	3	3	
Rated input current [A]	15.4	19.6	27.3	
Recommended wire gauge ¹⁾ [awg]	12	10	10	
Output Ratings				
Rated output power [kVA]	8.3	11	17	
Rated motor power [kW]	5.5	7.5	11	
Rated output current [A]	11	14	21	
Peak current (30 seconds) ²⁾ [A]	21.6	29.7	36	
Over current fault (E.O.C) trip level [A]	25.9	35.6	43.2	
Output voltage [V]	3 x 0...Vsupply			
Output frequency [Hz]	Generally 0 to 599Hz (limited by carrier frequency)			
Rated switching frequency ³⁾ [kHz]	8	8	4	8
Maximum switching frequency [kHz]	16	16	16	16
Power loss at rated operation ⁴⁾ [W]	250	320	350	290
Stall current at 4kHz [A]	12	16.5	24	24
Stall current at 8kHz [A]	12	16.5	16	19
Stall current at 16kHz [A]	12	10	10	8.4
Braking Circuit				
Min. braking resistance [Ohm]	39	39	39	39
Typ. braking resistance [Ohm]	100	85	56	
Max. braking current [A]	21	21	21	21
Installation Information				
Max. shielded motor cable length ⁵⁾ [ft]	300		330	
Tightening torque for power terminals [in lb]	4.5	4.5	11	
Environmental				
Max. heat sink temperature TOH [°C]	90°C / 194°F			
Storage temperature [°C]	-25...70 °C / -13...158°F			
Operating temperature [°C]	-10...45 °C / 14...113°F			
Housing design / protection	Chassis/IP20 /Pollution Degree 2			
Relative humidity	max. 95% without condensation			
Approvals				
Tested in accordance with...	EN 61800-3 /UL508C			
Standards for emitted interference	EN 55011 Class B/EN 55022 Class A			
Standards for noise immunity	IEC 1000-4-2 / -3 / -4 / -5/ -6			
Climatic category	3K3 in accordance with EN 50178			



The recommended motor rating is for 4/6 pole standard motors. When using motors with different numbers of poles, the inverter must be dimensioned based on the motor rated current. Contact the manufacturer for special frequency motors.

The power rating of the inverter must be de-rated for operation above 3,300 ft (1000 m). Reduce the rated power 1% for each additional 330 ft (100 m). The maximum elevation for operation is 6,560 ft (2000 m)

Inverter Size	16	17	18	19
Recommended Motor Power [hp]	20	25	30	40
Housing size	G	G	H	H
Unit Hardware	2	2	2	2
Input Ratings				
Supply voltage [V]	305...528 ±0 (480 V Nominal voltage)			
Supply voltage frequency [Hz]	50 / 60 +/- 2			
Input phases	3	3	3	3
Rated input current [A]	35	44	52	57
Recommended wire gauge ¹⁾ [awg]	8	6	6	4
Output Ratings				
Rated output power [kVA]	23	29	35	42
Rated motor power [kW]	15	18.5	22	30
Rated output current [A]	27	34	40	52
Peak current (30 seconds) ²⁾ [A]	49.5	63	75	90
Over current fault (E.OC) trip level [A]	59.4	75.6	90	108
Output voltage [V]	3 x 0...Vsupply			
Output frequency [Hz]	Generally 0 to 599Hz (limited by carrier frequency)			
Rated switching frequency ³⁾ [kHz]	8	4	8	8
Maximum switching frequency [kHz]	16	16	16	16
Power loss at rated operation ⁴⁾ [W]	310	360	470	540
Stall current at 4kHz [A]	33	42	42	60
Stall current at 8kHz [A]	21.5	21.5	42	50
Stall current at 16kHz [A]	9.5	-	25	30
Braking Circuit				
Min. braking resistance [Ohm]	25	25	9	9
Typ. braking resistance [Ohm]	39	28	22	16
Max. braking current [A]	30	30	90	90
Installation Information				
Max. shielded motor cable length ⁵⁾ [ft]	330			
Tightening torque for power terminals [in lb]	11	11	35	35
Environmental				
Max. heat sink temperature TOH [°C]	90°C / 194°F			
Storage temperature [°C]	-25...70 °C / -13...158°F			
Operating temperature [°C]	-10...45 °C / 14...113°F			
Housing design / protection	Chassis / IP20 / Pollution Degree 2			
Relative humidity	max. 95% without condensation			
Approvals				
Tested in accordance with...	EN 61800-3 / UL508C			
Standards for emitted interference	EN 55011 Class B / EN 55022 Class A			
Standards for noise immunity	IEC 1000-4-2 / -3 / -4 / -5 / -6			
Climatic category	3K3 in accordance with EN 50178			

1) The wire gauge is based on the maximum fuse rating, copper wire with a 75°C insulation rating, THHW or equivalent. If circuit protection is selected based on the actual input current, the wire size could be reduced.

2) This is the peak output current limited by hardware regulation. The software current control reserves 5% for closed loop regulation.

3) This is the maximum carrier frequency the power stage can support. The actual operating carrier frequency is adjusted and limited by the control card.

4) This is the power dissipation at the rated carrier frequency, rated voltage and rated load. Operation at reduced carrier frequencies or reduced load will decrease this value.

5) Max motor cable length when using shielded cable, KEB EMI filter, and the installation must conform to EN55011 / EN55022.

Technical Data

2.2 Technical Data 480V (Size 20 to 26)

Inverter Size	20	22	23	24	26		
Recommended Motor Power [hp]	50	75	100	125	175		
Housing size	H	R	U	U	U		
Unit Hardware	2	2	3	2	2	2	3
Input Ratings							
Supply voltage [V]	305...528 ±0 (480 V Nominal voltage)						
Supply voltage frequency [Hz]	50 / 60 +/- 2						
Input phases	3	3	3	3	3		
Rated input current [A]	72	105	150	189	254		
Recommended wire gauge ¹⁾ [awg]	4	1	2/O	3/O	350		
Output Ratings							
Rated output power [kVA]	52	80	104	125	173		
Rated motor power [kW]	37	55	75	90	132		
Rated output current [A]	65	96	136	172	231		
Peak current (30 seconds) ²⁾ [A]	135	172	230	225	270	375	450
Over current fault (E.OC) trip level [A]	162	207	276	270	324	450	540
Output voltage [V]	3 x 0...Vsupply						
Output frequency [Hz]	Generally 0 to 599Hz (limited by control board and carrier frequency)						
Rated switching frequency ³⁾ [kHz]	4	8	8	8	8	4	4
Maximum switching frequency [kHz]	16	16	16	8	8	8	12
Power loss at rated operation ⁴⁾ [W]	900	1500	1500	1900	2400	2800	2800
Stall current at 4kHz [A]	83	115	173	165	198	330	330
Stall current at 8kHz [A]	83	115	150	150	180	180	225
Stall current at 16kHz [A]	45	63	98	-	-	-	125 ⁵⁾
Braking Circuit							
Min. braking resistance[Ohm]	9	7.5	5	4	4.0		
Typ. braking resistance[Ohm]	13	9	6	6	4.3		
Max. braking current [A]	90	104	160	200	200		
Installation Information							
Max. shielded motor cable length ⁵⁾ [ft]	165				165		
Tightening torque for power terminals [in lb]	35		133	133	220		
Environmental							
Max. heat sink temperature TOH [°C]	90°C / 194°F	°C	90°C	90°C	60°C		
Storage temperature [°C]	-25...70 °C / -13...158°F						
Operating temperature [°C]	-10...45 °C / 14...113°F						
Housing design / protection	Chassis / IP20 / Pollution Degree 2						
Relative humidity	max. 95% without condensation						
Approvals							
Tested in accordance with...	EN 61800-3 /UL508C						
Standards for emitted interference	EN 55011 Class B / EN 55022 Class A						
Standards for noise immunity	IEC 1000-4-2 / -3 / -4 / -5/ -6						
Climatic category	3K3 in accordance with EN 50178						

1) The wire gauge is based on the maximum fuse rating, copper wire with a 75°C insulation rating, THHW or equivalent. If circuit protection is selected based on the actual input current, the wire size could be reduced.

2) This is the peak output current limited by hardware regulation. The software current control reserves 5% for closed loop regulation.

3) This is the maximum carrier frequency the power stage can support. The actual operating carrier frequency is adjusted and limited by the control card.

4) This is the power dissipation at the rated carrier frequency, rated voltage and rated load. Operation at reduced carrier frequencies or reduced load will decrease this value.

5) Max motor cable length when using shielded cable, KEB EMI filter, and the installation must conform to EN55011 / EN55022.

Dimensions

2.3 Dimensions and weight

E Housing

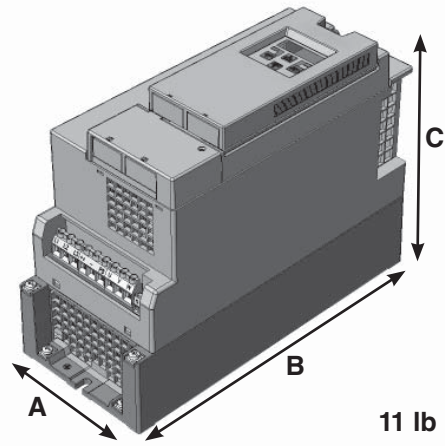

G Housing

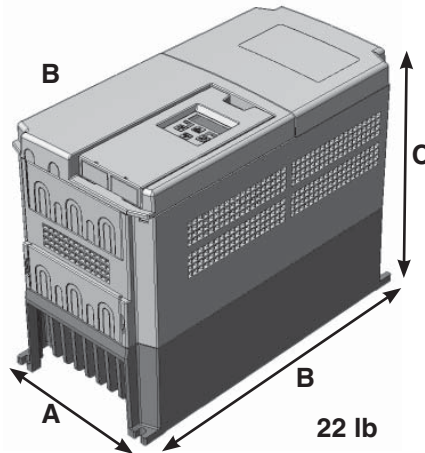

H Housing

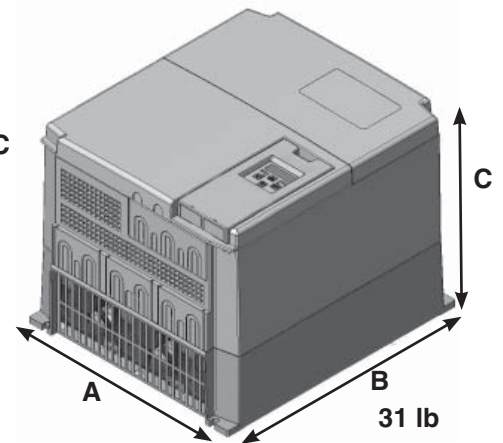

R Housing

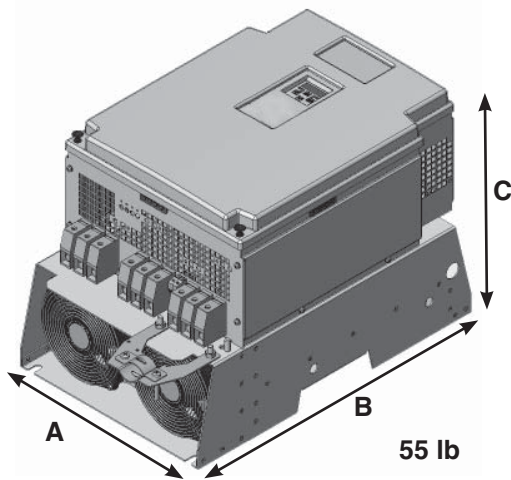

U Housing

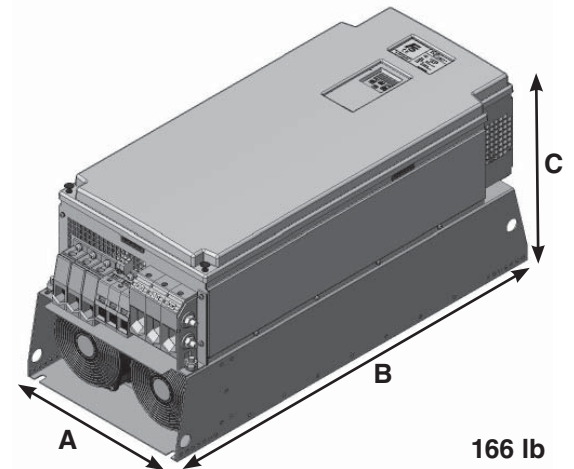

Dimensions in inches

Housing	A	B	C	F	G	H
E	5.12	11.4	8.75	0.28	-	10.8
G	6.7	13.4	10.0	0.28	5.9	13.0
H	11.7	13.4	10.0	0.28	9.8	13.0
R	13.5	20.5	14.0	0.394	11.8	19.5
U	13.5	31.5	14.0	0.394	11.8	30.5

Mounting Holes

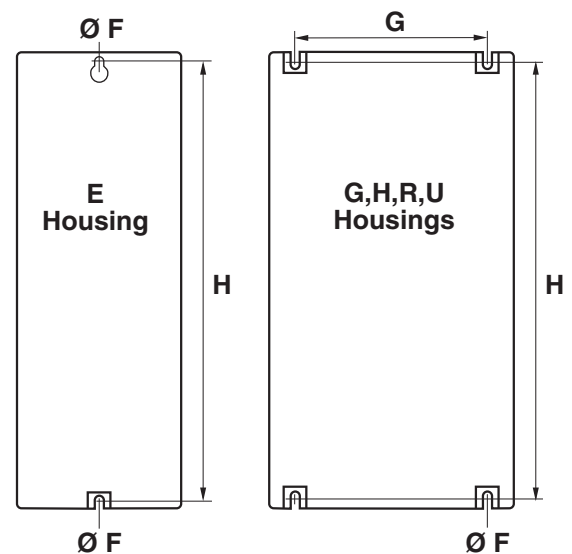

Power Circuit Terminals

2.4 Summary of the power circuit terminals

Housing size E ⚠ Verify input voltage with name plate for proper connection 230V or 480V

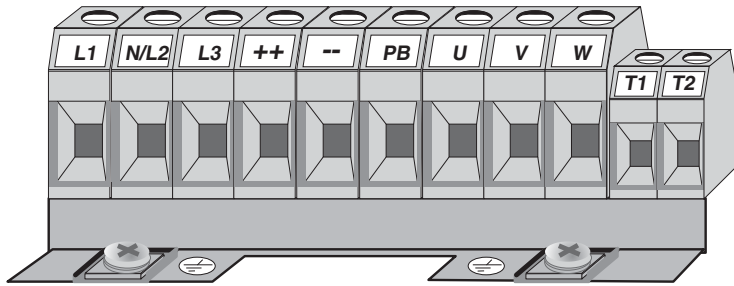

- L1, L2, L3** 3 phase supply voltage
- ++, --** Connection for DC supply
- ++, PB** Connection for braking resistor
- U, V, W** Motor connection
- T1, T2** Connection for temperature sensor
-  Connection for earth ground

Terminal Tightening Torque: 4.5 inlbs (0.5Nm)

Housing size G ⚠ Verify input voltage with name plate for proper connection 230V or 480V

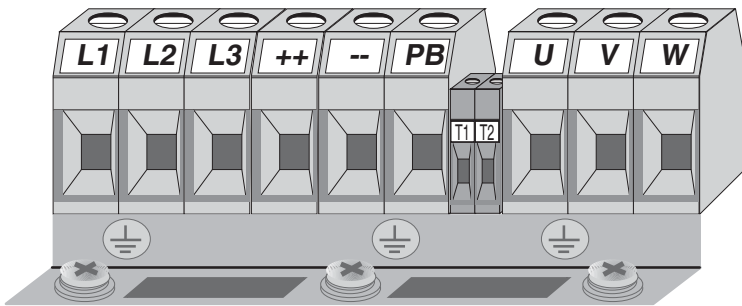

- L1, L2, L3** 3 phase supply voltage
- ++, --** Connection for DC supply
- ++, PB** Connection for braking resistor
- T1, T2** Connection for temperature sensor
- U, V, W** Motor connection
-  Connection for earth ground

Terminal Tightening Torque: 11 inlbs (1.2Nm)

Housing size H ⚠ Verify input voltage with name plate for proper connection 230V or 480V

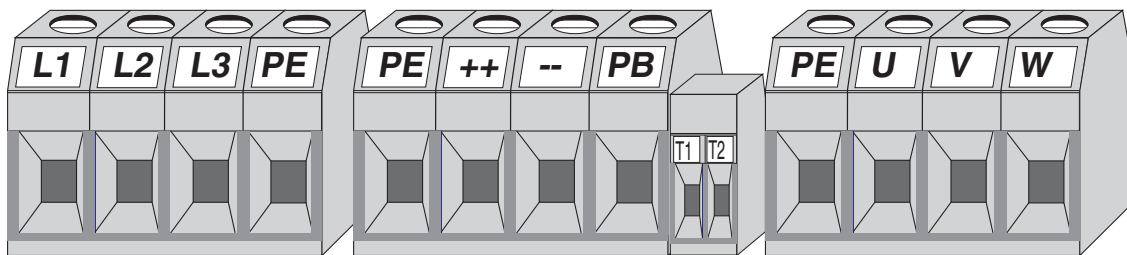

- L1, L2, L3** 3 phase supply voltage
- ++, --** DC supply connection
- ++, PB** Connection for braking resistor
- T1, T2** Connection for temperature sensor
- U, V, W** Motor connection
- PE** Connection for earth ground

Terminal Tightening Torque: 35 inlbs (4Nm)

Housing size R and U **Verify input voltage with name plate for proper connection 230V or 480V**

Note always verify input voltage with name plate for proper connection

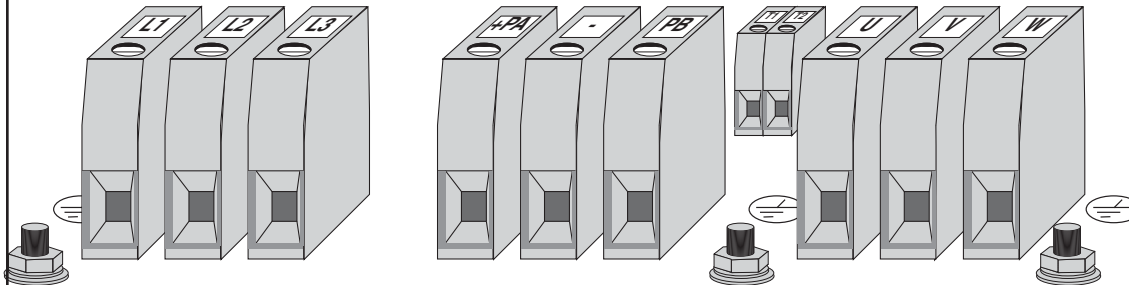

L1, L2, L3
+ +, - -
+ +, PB

3 phase supply voltage
DC supply connection
Connection for braking resistor

T1, T2
U, V, W

Connection for temperature sensor
Motor connection
Connection for earth ground M8 stud.

Note: Ground Stud and Nut shall be connected with UL Listed Ring Connectors (ZMVV), rated suitable.

Terminal Tightening Torque: R housings size <= 22: 53 inlb (6Nm)
R & U housings size 23/24: 133inlbs (15Nm)
U housings sizes > 24: 221inlbs (25Nm)
Ground nut on R & U housings: 89inlbs (10Nm)

2.5 Connection of the power circuit

See technical data in Section 2.1-2.2 to match the wiring diagram to inverter size and housing type.



If the supply voltage is connected to the motor terminals, the unit will be destroyed!



Pay attention to the supply voltage 230/480V and the correct polarity of the motor!

Wiring diagram 1

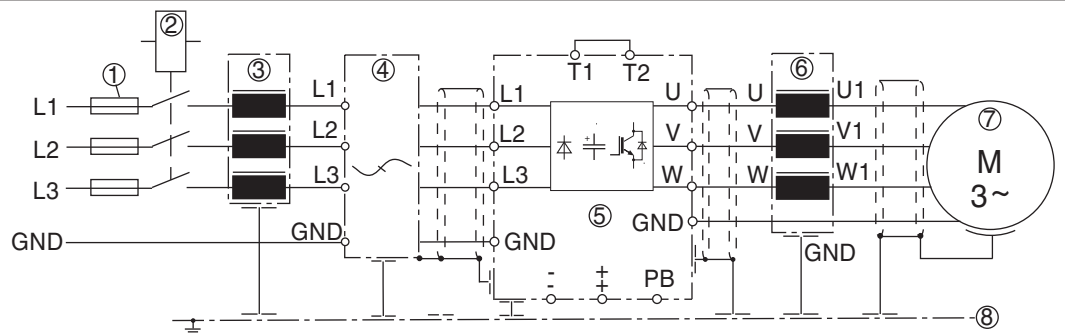

Wiring diagram 2

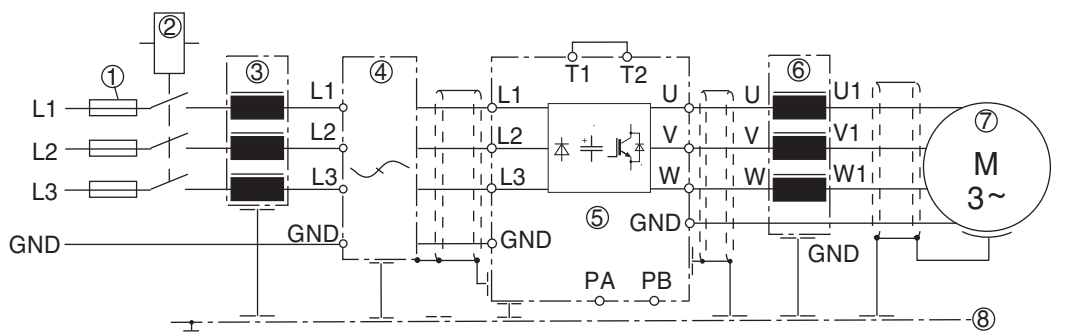

Connection of the Power Circuit

Wiring diagram 3

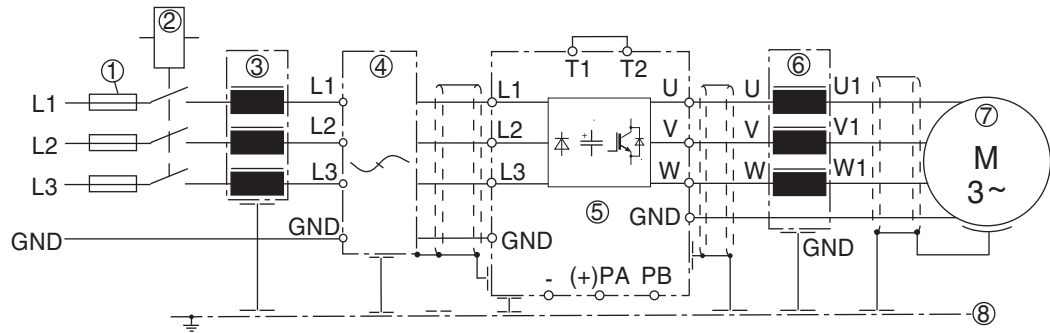

- | | |
|--|---------------------------------------|
| ① Supply fuse | ⑤ COMBIVERT F5 |
| ② Disconnect switch or contactor | ⑥ Motor choke or output filter |
| ③ Line choke | ⑦ Motor |
| ④ Interference suppression filter | ⑧ Sub panel in control cabinet |

External motor temperature sensor (for all units)

Don't install sensor wires with control wires!

Must use double shield when running these wires with motor wires!

It is necessary to activate this function via software parameter! See US.33

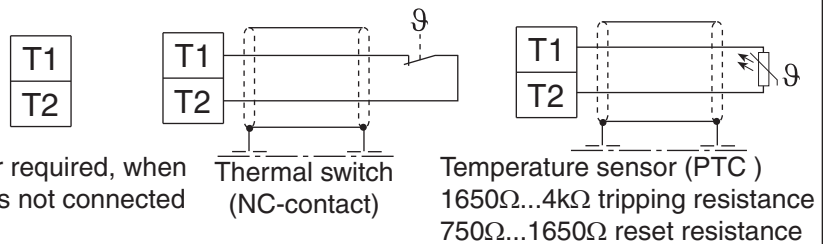

Connection of braking resistor (Braking circuit installed as standard in housing sizes E,G,H, R and U.)

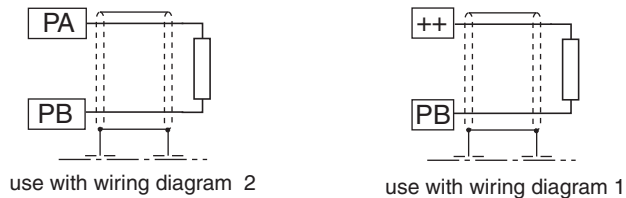

Braking resistor with line side over temperature cutoff



This is the only way to turn off voltage to the resistor in the event of failure of the internal braking transistor of the inverter.

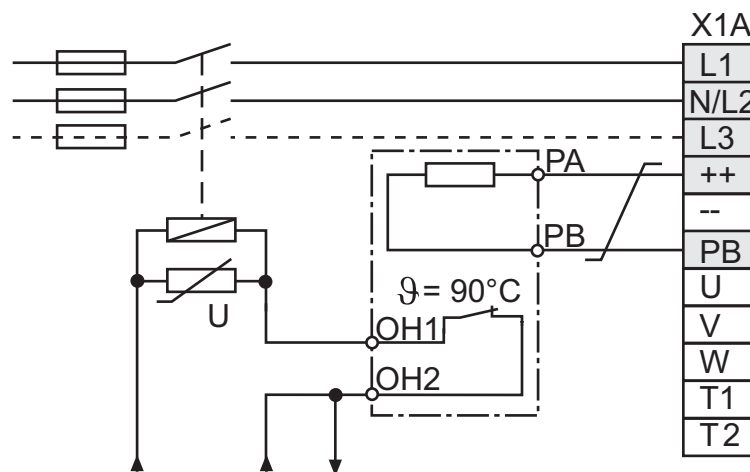

24VDC or 120VAC contactor control voltage

Note: a NC thermal switch not PTC device on the resistor is required.

2.6 Time dependent overload curve

If the load current exceeds the rated current but is below the over current level, an overload timer begins counting. The rate at which the timer increments is a function of load current. The higher the current the faster the increments. When the counter reaches the limit the fault E.OL is triggered and the output to the motor is shut off. At this point the inverter begins a cool down period where the inverter is allowed to cool before the fault can be reset.

① Less than size 24

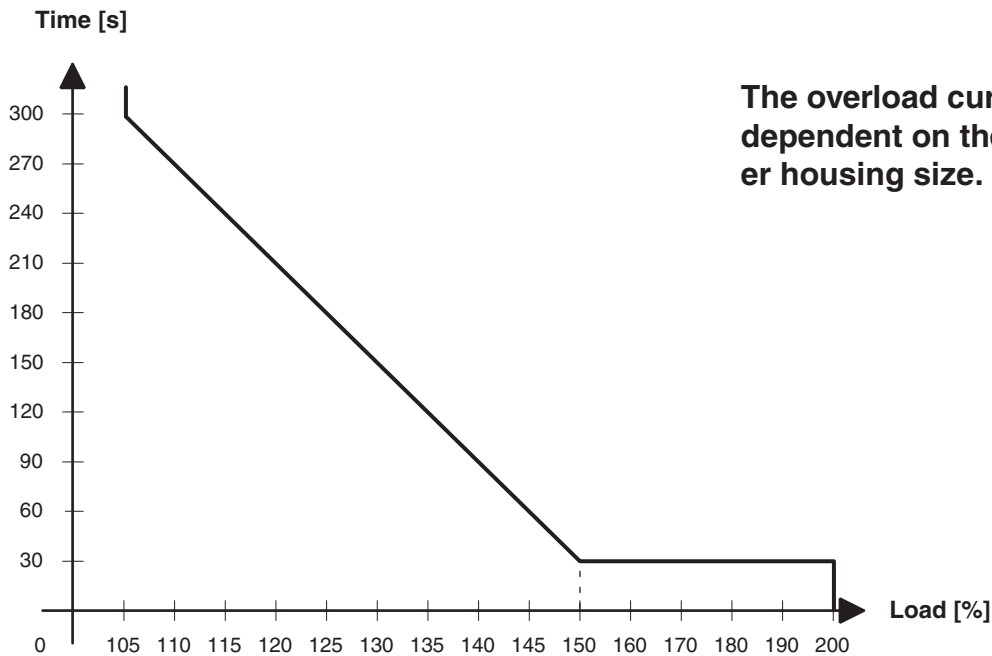

② Size 24 and greater

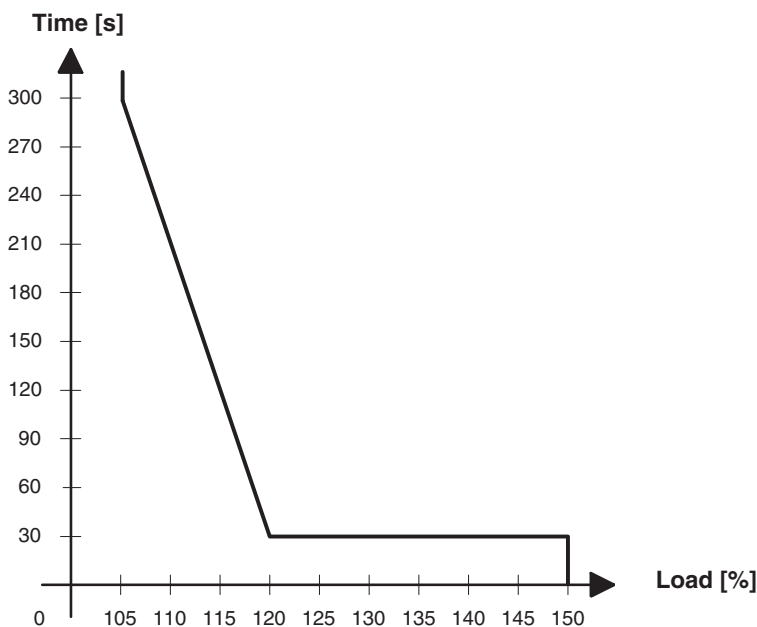

Overload Characteristic

2.7 Low Speed Overload (E.OL2)

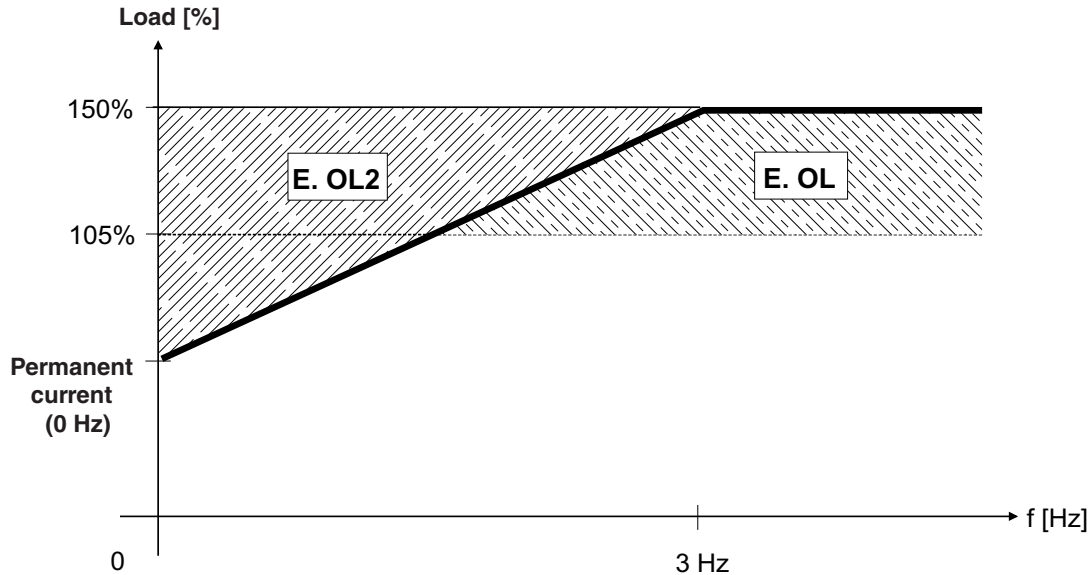

At low speeds (below 3 Hz) the rms current flowing through the power transistors is higher, reaching 1.4 times the rated 60Hz rms value. This is caused by the low frequency sine wave created by the PWM. As a result, the continuous output current must be limited at low speeds to prevent the power transistors from overheating. The COMBIVERT F5 will drop the carrier frequency to 4kHz if necessary to be able to continue to provide current to the motor. Once the output frequency rises above 3Hz or the current drops below the levels listed below, the carrier frequency will be returned to the higher value.

230V Maximum stall current (amps at 0Hz)										
Inverter Housing	Carrier Frequency	Inverter Size								
		13	14	15	16	17	18	19	20	21
E	8 kHz	24	24							
	16 kHz	16.8	16.8							
G	8 kHz		33	31						
	16 kHz		33	26						
H	8 kHz			53	72.5	109				
	16 kHz			53	73	92				
R	8 kHz					84	100	115	145	180
	16 kHz					50	70	70	102	102

460V Maximum stall current (amps at 0Hz)														
Inverter Housing	Carrier Frequency	Inverter Size												
		13	14	15	16	17	18	19	20	21	22	23	24	26
E	8 kHz	12	17	17										
	16 kHz	12	10	10										
G	8 kHz	12	17	19	22.0									
	16 kHz	12	12	8.4	9.5									
H	8 kHz		24	33	42	50	54	83						
	16 kHz		15	20	25	30	36	45						
R	8 kHz					50	60	75	81	115	165			
	16 kHz					40	27	34	45	63	150			
U	4 kHz										165	198	330	330
	8 kHz										150	180	180	225
	16 kHz										-	-	-	

X2A

3.1 Control Circuit

3.1.1 Terminal Strip Connections



PIN	Function	Name	Description
1	Analog input 1 +	AN1+	Pattern speed input or torque command input
2	Analog input 1 -	AN1-	
3	Analog input 2 +	AN2+	Pre-torque input
4	Analog input 2 -	AN2-	
5	Analog output 1	ANOUT1	Analog output of the real speed 0...±10 VDC (0...± 100 %)
6	Analog output 2	ANOUT2	
7	+10V Output	CRF	Analog supply voltage for speed ref.
8	Analog Common	COM	Common for analog in- and outputs
9	Analog Common	COM	Common for analog in- and outputs
10	Optional Function	OPT	Inputs 11,12,13 provide binary coded speed selection of up to 7 speeds. See parameter LF.2. With analog control (LF.2=R 5Pd or Rb5Pd) these inputs are not used!
11	Leveling Speed	S _L	
12	High Leveling Speed	S _{HL}	
13	High Speed	S _H	
14	Up	U	Preset rotation; "Up" has priority
15	Down	D	
16	Drive Enable	ST	Enable/Disable; response time < 1msec; enable instantly turns off motor current
17	Reset	RST	
18	Digital Out 1	O1	At speed signal (turns off if the actual speed deviates from the set speed)
19	Digital Out 2	O2	Fault signal (activates when there is a drive fault)
20	24V-Output	V _{out}	Approx. 24V output (max.100 mA load)
21	20...30V-Input	V _{in}	Voltage input when an external 24VDC supply is used
22	Digital Common	0V	Common for digital in-/outputs
23	Digital Common	0V	Common for digital in-/outputs
24	RDY Relay	NO	Ready; relay drops when a drive fault occurs (E.XX). Picks after fault is cleared with RST input or power cycle See Parameter do.82
25		NC	
26	max. 30 V DC, 1 A	COM	
27	DRO Relay	NO	Drive On; relay picks after all of the follow conditions are met: enable picked, direction picked, motor phase current check passes. Relay drops when one of the following occurs: enable dropped, direction dropped and actual speed is zero, drive fault (E.XX). See Parameter do.83
28		NC	
29	max. 30 V DC, 1 A	COM	

Installation and Connection

3.1.2 Connection of the control signals

In order to prevent a malfunction caused by interference voltages on the control inputs, the following steps should be observed:



- Establish a true earth ground for all ground connections!
- Do not connect drive signal commons to earth ground!
- Use shielded cable with twisted pair wires!
- Terminate shield wires to earth ground, only at inverter!
- Separate control and power wires by 8" or more!
- Control and power wires should cross at a right angle!

3.1.3 Digital Inputs

Use of **internal** voltage supply

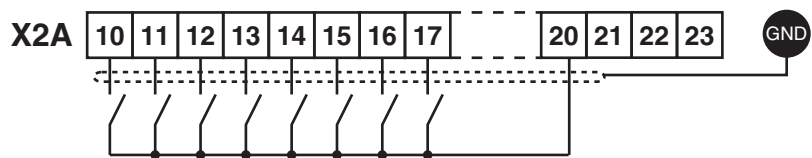

Use of **external** voltage supply

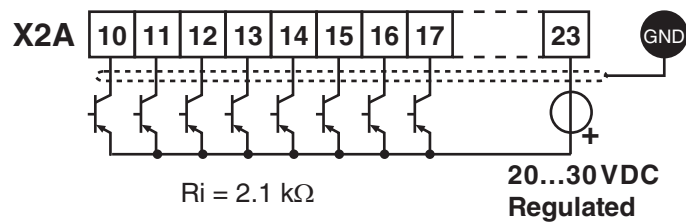

3.1.4 Analog Inputs

Speed Pattern, Torque Command

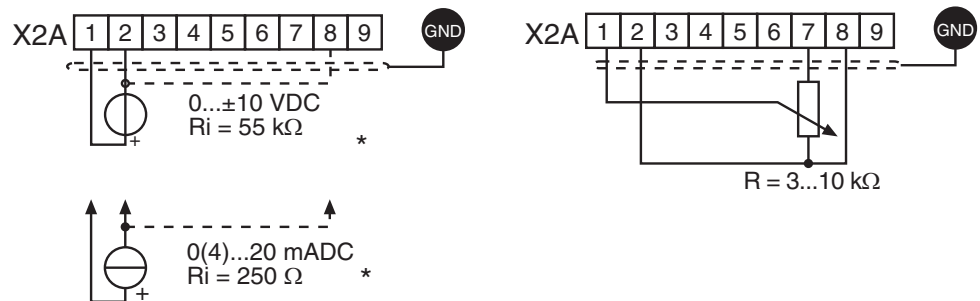

Connect unused analog inputs to common to eliminate noise signals!

Installation and Connection

3.1.5 Voltage Input / External Power Supply

The supply to the control circuit through an external voltage source keeps the control in operational condition even if the power stage is switched off. To prevent undefined conditions (false triggering), first switch on the power supply then the inverter.

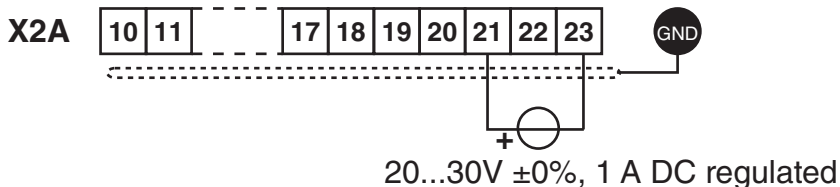

3.1.6 Digital Outputs

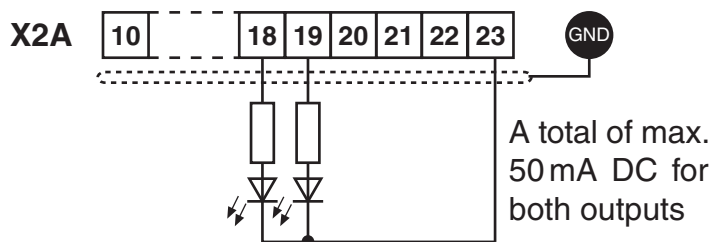

3.1.7 Relay Outputs

In case of inductive loads on the relay outputs, protective wiring must be provided (e.g. RC or diode arc suppression)!

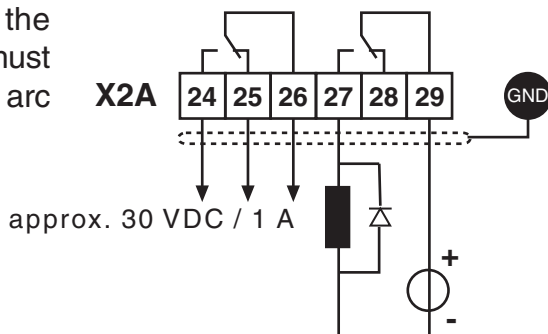

3.1.8 Analog Outputs

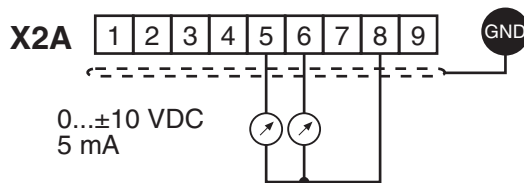

3.1.9 Voltage Output

The voltage output serves for triggering the digital inputs as well as for supplying external control devices. Do not exceed the maximum output current of 100 mA. This output is short circuit protected.

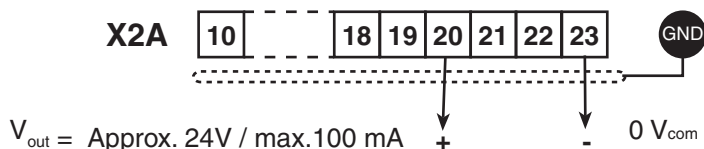

Installation and Connection

3.2 Encoder Connections

3.2.1 X3A RS422/TTL Incremental Encoder Input



ONLY when the inverter is switched off and the voltage supply is disconnected may the feedback connectors be removed or connected!

Connect the incremental encoder mounted on the motor to the 15-pin Sub-D connector at X3A on the COMBIVERT F5M. This connection provides speed feedback and is imperative to the proper operation of the F5.

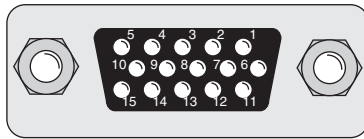

Pin No.	Signal
3	A-
4	B-
8	A+
9	B+
11	V_{var} 24...30 V
12	+5.2 V
13	0V (com)
14	N-
15	N+
Shield	Housing

The internal voltage of " V_{var} " 24...30 V ⁽¹⁾ is an unregulated supply and will allow up to 170 mA max. current draw, for X3A and X3B total. If higher voltages / currents are required, then an external power supply must be provided.

The +5.2 V is a regulated voltage supply generated from V_{var} and will allow up to 500 mA max. current draw, for X3A and X3B total. If additional current is required from the +5.2 V output, the current from V_{var} decreases in accordance with following formula:

$$I_{var} = 170 \text{ mA} - \frac{5.2 \text{ V} \times I_{+5V}}{V_{var}}$$

The following specifications apply to encoder interface X3A and X3B, channel 1 and 2 respectively:

- Max. operating frequency: 300 kHz.
- Internal terminating resistance: $R_t = 120 \Omega$
- RS422 or TTL level square wave voltage level: 2...5 Vdc

Input Wiring

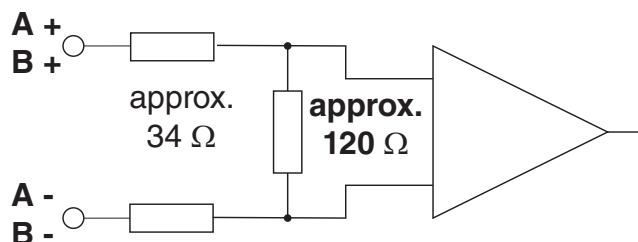

1. Maximum Encoder voltage: +5.2 V

2. Encoder line number: 1...16383 ppr
 2500 ppr is recommended and gives best speed resolution and regulation performance for applications with a maximum motor speed of up to 4500 rpm.

F5M Interface cutoff frequency: 300 kHz
 Observe cutoff frequency of the encoder:

$$f_{\text{limit}} > \frac{g \cdot n_{\text{max}}}{60}$$

g = Encoder increments (ppr)

n = Encoder speed (rpm)

f = Encoder operating frequency (Hz)

3. Signal specifications:

Four signals consisting of two square-wave pulses that are electrically 90° out of phase and their inverse signals (TTL-push-pull signals / RS422-conformity). Minimum "on" voltage level is 2.0V and maximum "off" voltage level is 0.5V. The encoder must be electrically isolated from the motor shaft. Otherwise noise from the motor may corrupt the encoder signals.

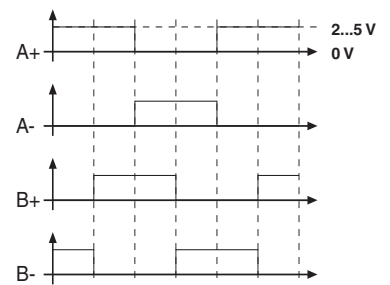

4. Cable specifications: The encoder cable shall not be so long such that the voltage drop in supply voltage on the encoder cable results in a voltage less than the minimum encoder supply voltage. Typically encoder lines should not be longer than 160 ft (50 m). The following must be valid for trouble free operation.

$$[(I_{\text{Encoder}} \cdot R_{\text{Line}}) + V_{\text{Encoder (min)}}] < +5.2 \text{ V}$$

R_{Line} is the sum of the resistance of the supply wires both +V and com.

For maximum noise immunity, the encoder cable shall consist of individually shielded twisted pairs with one overall shield. The individual shields should be connected to 0V (com) pin 13 on the Sub D connector and be kept separate from the outer shield. The outer shield should be connected to earth ground, the housing of the Sub D connector.



The cable shall be kept a minimum of 8 inches (20 cm) away from all wires having greater than 24VDC on them. For best results run the encoder cable in a separate conduit from the controller to the motor.

Installation and Connection

3.2.2 X3A TTL Inc. Enc. In Screw Terminals



ONLY when the inverter is switched off and the voltage supply is disconnected may the feedback connectors be removed or connected!

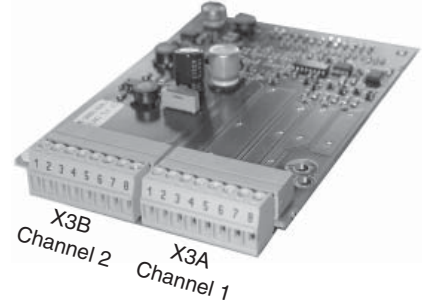
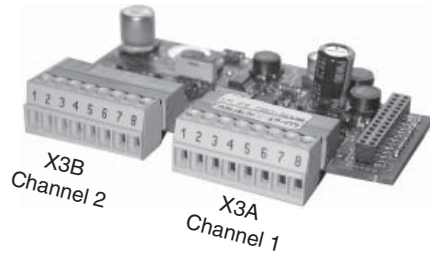

Connect the incremental encoder mounted on the motor to the 8 position terminal connector at X3A. This connection provides speed feedback and is imperative to the proper operation of the F5M.

Plug in screw terminal X3A		
		1 2 3 4 5 6 7 8
Pos	Signal	Description
1	A+	TTL incremental encoder track A
2	A-	Differential signal to A+
3	B+	TTL incremental encoder track B
4	B-	Differential signal to B+
5	N+	TTL Zero track
6	N-	Difference signal to N+
7	15/24V	Voltage output 15/20...30V, power supply for the encoder, switchable with dip switch S100
8	COM	0V reference for voltage supply
-	GND	connect the outer cable shield to an earth ground connection on the elevator drive .

The following specifications apply to encoder interface X3A, channel 1

- Max. operating frequency: 300 kHz.
- Maximum cable length: 50m (164 ft) (RS422)
- Internal terminating resistance: $R_t = 120 \Omega$
- RS422 or TTL level square wave voltage level: 2...5 Vdc

Note: For 5V TTL encoders, a 5V supply is available on second interface, X3B terminal 7.



If an incremental encoder does not have N+/N- tracks then the corresponding inputs on the encoder interface card must be jumpered high/low or the drive will trigger the error, E.ENC1. For example, connect N+ (X3A.5) to 5V (X3B.7) and N- (X3A.6) to 0V (X3A.8).

Input equivalent circuit

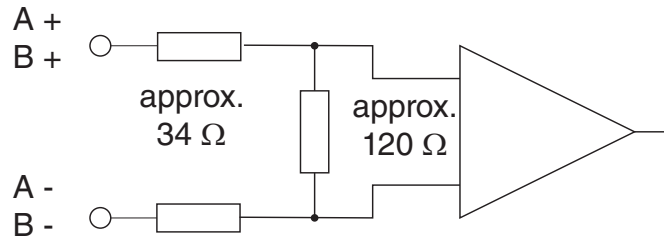

Selection of the supply voltage

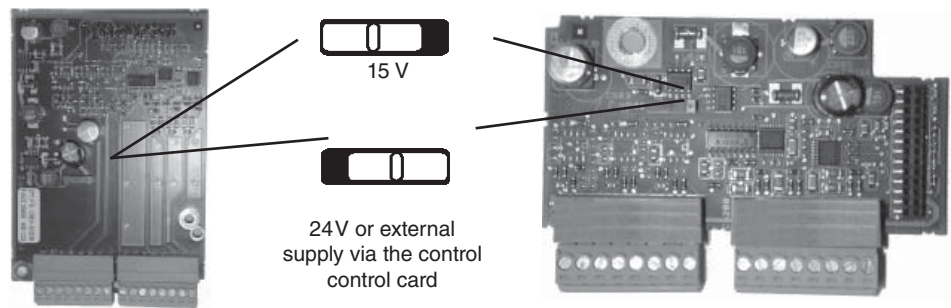

The maximum load capacity is dependant on the selected voltage supply.

Max. load capacity with 15V internal supply:300 mA

Max. load capacity with 24V internal supply:170 mA

Max. load capacity with an external 24V supply 1 A (dependent on the external voltage source)

The specified currents are reduced by any current drawn on the second interface X3B.

For maximum noise immunity, the encoder cable shall consist of individually shielded twisted pairs with one overall shield. The individual shields should be connected to 0V (com) pin 8 on the X3A terminal strip and be kept electrically isolated from the outer shield. The outer shield should be connected to earth ground on the elevator drive.



The cable shall be kept a minimum of 8 inches (20 cm) away from all wires having greater than 24VDC on them. For best results run the encoder cable in a separate conduit from the controller to the motor.

Installation and Connection

3.2.3 X3A Hiperface Encoder

The Hiperface encoder provides two differential analog channels for incremental position and one serial data channel for communication with the encoder. This serial data channel can provide the drive with the absolute position of the motor as well as other operating data.

The analog cosine and sine wave signals of tracks A and B have a voltage of 1 V_{pp} with an Offset of 2.5 V. This analog voltage is measured and a high resolution position value is determined as a result. This high resolution position value is very important for good speed control of a gearless motor.



Therefore it is absolutely necessary to ensure these signals are well shielded! Noise on the analog signals resulting from breaks in the shield or improper shield termination will result in vibration in the motor and poor ride quality.

The internal stored ppr value is compared to the adjusted value in LF.27. If the two are not the same the drive will trigger the error E.ENCC. Refer to parameter LF.26 for more information.

During start-up and then every 100 ms a request is transmitted to the encoder and the absolute position is read out via serial communication. This initial readout of the absolute position provides the drive with the commutation angle for permanent magnet motors. On the very first operation of a permanent magnet motor it is necessary to synchronize the encoder position to one of the pole pairs of the motor. See parameter LF.77 for more information and section 5.11.1.

During normal operation, the difference between the internal absolute position of the encoder and the measured position value in the drive is compared. If the two deviate by more than 2.8 degrees, the drive will trigger the error, E.ENCC. Refer to parameter LF.26 for more information.

Hiperface encoders also provide memory for the user to store a copy of the motor data. The drive supports the functionality to read and write the motor data to the encoder. See parameter LF.26 for more information.

If there is an excess length of cable (10 feet or less), it is OK to coil it into a loop in the controller. Maintain a minimum diameter of 1 foot and keep the cable at least 8 inches away from all high voltage power wires.

Installation and Connection

Drive connection X3A Female SUBD 15 HD

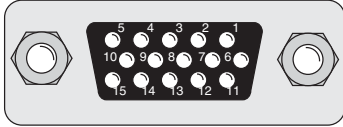

Pin No	Signal Description
1	- -
2	- -
3	REF_COS signal input A- (difference signal to COS+)
4	REF_SIN signal input B- (difference signal to SIN+)
5	- -
6	- -
7	- -
8	COS+ signal input A (absolute track for counter and direction detection)
9	SIN+ signal input B (absolute track for counter and direction detection)
10	+7.5V Supply voltage for encoder
11	- -
12	- -
13	COM reference potential for supply voltage
14	-DATA Data channel RS485
15	+DATA Data channel RS485

Max. Load Capacity depending on Voltage Supply

Max. load capacity at +7.5 V:300 mA. The specified current is reduced by the load current taken from the second encoder interface X3B interface (see section 3.2.6).

HIPERFACE Cable

Pre-manufactured Hiperface cables offer the best solution against noise and disturbance while at the same time saving installation time. The cables come in standard lengths of 5m,10m,15m,20m, 25m, and 30m.

Cable Part Number

00.S4.809-00xx xx = length in meters, 10 = 10 meters

Mating Connector

00.90.912-003U for encoder (solder type)

Running in Conduit

When this cable must be pulled through metallic conduit, it is necessary to over size the conduit! Use of a 1 1/2 inch trade size conduit will allow the connectors to pass without removal of the connectors. Cutting the cable, or removal of the connectors or their housings voids the warranty and will result in problems with electrical noise after the fact.

Circular connector on HIPERFACE encoder.

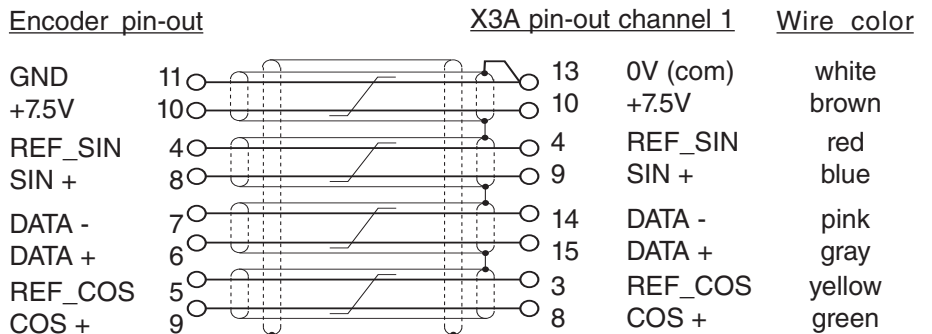
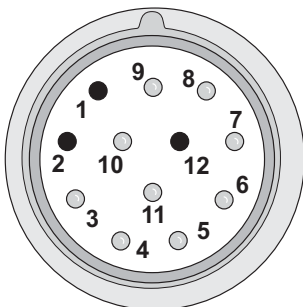

Shield wire tied to housing

Shield wire tied to housing which is earth ground.

Note: Inner pair shields are tied to 0V (com), pin 13, not earth ground!

Installation and Connection

Technical Data

Input resistance:	120 Ohm
Process data channel:	1Vpp
Parameter channel:	EIA RS485 half duplex
Maximum input frequency:	200 kHz
Encoder line number:	1024 inc
Maximum cable length:	<100 m <i>(based on signal levels, otherwise see below)</i>

Cable length based on cable resistance

The maximum cable length is calculated as follows:

$$\text{Length} = \frac{V - V_{\min}}{I_{\max} * R} = \frac{7.5V - 7.0}{0.2A * 0.07 \Omega/m} = 35.7 \text{ m}$$

where

I_{\max} = supply current of encoder [amps]

V = voltage supply of the drive = 7.5V

V_{\min} = minimum supply voltage of the encoder

R = cable resistance (0.07 Ω/m) for KEB cables

The following Hiperface®-encoders have been tested for use:

- Stegmann SRS 50/60 Singleturn; SCS 60/70 Singleturn
- Stegmann SRM 50/60 Multiturn; SCM 60/70 Multiturn

However, this does not restrict the use of rotary encoder with same specifications of other manufacturers

Recognition of encoder loss or exchange

The recognition of encoder loss or exchange is a software function and dependent on the encoder type. If the drive senses that the serial communication to the encoder has stopped, it will trigger the error E.ENCC.



If the encoder is replaced or disconnected, the drive will trigger an error or warning that the encoder was changed. The drive will display the error message E.ENCC and lock out operation by changing LF.3 to configuration mode. No further operation is possible.

If the encoder was exchanged the drive will auto reset the E.ENCC fault but will remain in configuration mode because the user will need to learn the new encoder position before operation can continue. See section 5.11.1.

If there is an encoder triggered fault or problems with the encoder cables, the E.ENCC error will not clear and the problems must be diagnosed through parameter LF.26. To clear the E.ENCC error, it is necessary to go to parameter 0.LF.26, press "Func" and then press "Enter".

Installation and Connection

Signals Format of the analog channels

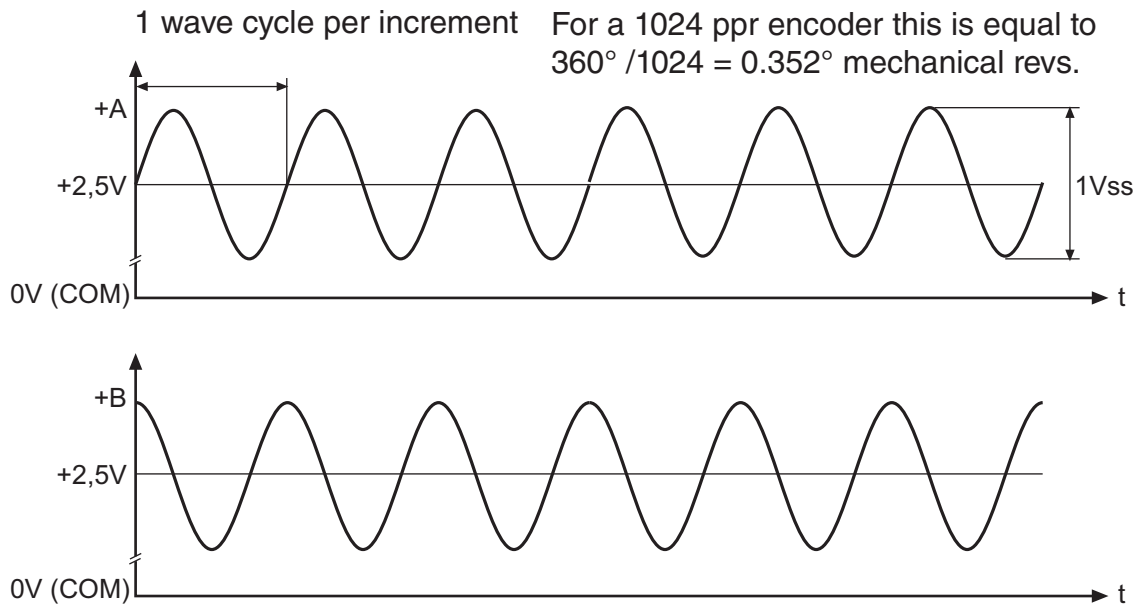

Installation and Connection

3.2.4 X3A EnDat Encoder

The EnDat encoder provides two differential analog channels for incremental position and one serial data channel with clock for communication with the encoder. This serial data channel can provide the drive with the absolute position of the motor as well as other operating data. The EnDat encoder must be version 2.1 or greater for compatibility reasons.

The analog cosine and sine wave signals of tracks A and B have a voltage of 1 V_{pp} with an Offset of 2.5 V. This analog voltage is measured and a high resolution position value is determined as a result. This high resolution position value is very important for good speed control of a gearless motor.



Therefore it is absolutely necessary to ensure these signals are well shielded! Noise on the analog signals resulting from breaks in the shield or improper shield termination will result in vibration in the motor and poor ride quality.

The internal stored ppr value is compared to the adjusted value in LF.27. If the two are not the same the drive will trigger the error E.ENCC. Refer to parameter LF.26 for more information.

During start-up and then every 30 ms a request is transmitted to the encoder and the absolute position is read out via serial communication. This initial readout of the absolute position provides the drive with the commutation angle for permanent magnet motors. On the very first operation of a permanent magnet motor it is necessary to synchronize the encoder position to one of the pole pairs of the motor. See parameter LF.77 for more information and section 5.11.1.

During normal operation, the difference between the internal absolute position of the encoder and the measured position value in the drive is compared. If the two deviate by more than 2.8 degrees, the drive will trigger the error, E.ENCC. Refer to parameter LF.26 for more information.

ENDAT encoders also provide memory for the user to store a copy of the motor data. The drive supports the functionality to read and write the motor data to the encoder. See parameter LF.26 for more information.

The clock signal serves as synchronisation for the serial data channel.

If there is an excess length of cable (10 feet or less), it is OK to coil it into a loop in the controller. Maintain a minimum diameter of 1 foot and keep the cable at least 8 inches away from all high voltage power wires.

Installation and Connection

Drive connection
X3A Female SUBD
15 HD

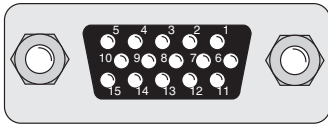

Pin No	Signal Description
1	- -
2	- -
3	REF_COS signal input A- (difference signal to COS+)
4	REF_SIN signal input B- (difference signal to SIN+)
5	- -
6	+ CLOCK synch. signal for serial data
7	- CLOCK synch. signal for serial data
8	COS+ signal input A (absolute track for counter and direction detection)
9	SIN+ signal input B (absolute track for counter and direction detection)
10	- -
11	- -
12	+ 5V Supply voltage for encoder
13	COM Reference potential for supply voltage
14	-DATA Data channel RS485
15	+DATA Data channel RS485

Max. Load Capacity depending on Voltage Supply

Max. load capacity at +5.0V; 300 mA. The specified current is reduced by the current taken from the second encoder interface X3B interface (see section 3.2.6).

EnDat Cable

Pre-manufactured EnDat cables offer the best solution against noise and disturbance while at the same time saving installation time. The cables come in standard lengths of 5m, 10m, 15m, 20m, 25m and 30m.

Cable Part Number

00.F5.0C1-40xx xx = length in meters, 10 = 10 meters

For lengths above 30 m a different cable is used.

00.F5.0C1-L0xx xx = length in meters, 40 = 40 meters

Mating Connector

00.90.912-004U for encoder (solder type)

Running in Conduit

When this cable must be pulled through metallic conduit, it is necessary to over size the conduit! Use of a 1 1/2 inch trade size conduit will allow the connectors to pass without removal of the connectors. Cutting the cable, or removal of the connectors or their housings voids the warranty and will result in problems with electrical noise after the fact.

Circular connector on EnDat encoder.

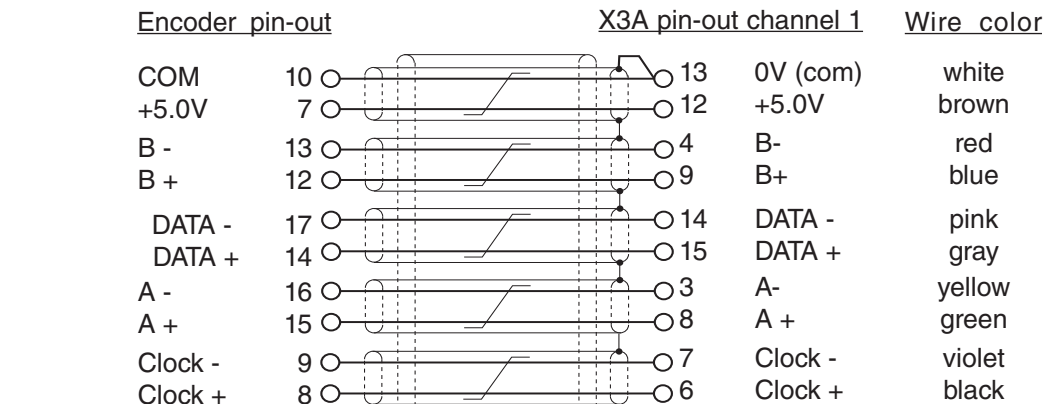
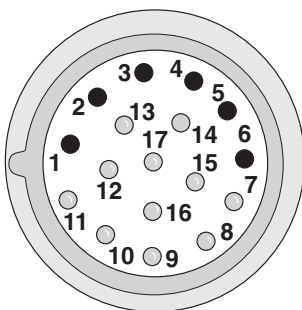

Shield wire tied to housing

Note: Inner pair shields are tied to 0V (com), pin 13, not earth ground!

Shield wires tied to housing which is earth ground.

Installation and Connection

Technical Data

Input resistance:	120 Ohm
Process data channel:	1Vpp
Parameter channel:	EIA RS485 half duplex
Clock signal output:	EIA RS485
Maximum input frequency:	200 kHz
Encoder line number:	1...2048 inc
Maximum cable length:	100 m <i>(based on signal levels, otherwise see below)</i>
Cable length based on cable resistance	

The maximum cable length is calculated as follows:

$$\text{Length} = \frac{V - V_{\min}}{I_{\max} * R} = \frac{5.25V - 4.75V}{0.2A * 0.003 \Omega/m} = 83.3 \text{ m}$$

where

I_{\max} = supply current of encoder [amps]

V = voltage supply of the drive = 5.25V

V_{\min} = minimum supply voltage of the encoder

R = cable resistance (0.07 Ω/m) for Standard KEB cables
(0.03 Ω/m) for type "L" KEB cables

The following ENDAT encoders have been tested for use:

- Heidenhain ECN 1313 single turn; ECI 1317 Singleturn
- HeidenhainROQ 425 Multiturn; EQI 1329 Multiturn

However, this does not restrict the use of rotary encoder with same specifications of other manufacturers

The recognition of encoder loss or exchange is a software function and dependent on the encoder type. If the drive senses that the serial communication to the encoder has stopped, it will trigger the error E.ENCC.



If the encoder is replaced or disconnected, the drive will trigger an error or warning that the encoder was changed. The drive will display the error message E.ENCC and lock out operation by changing LF.3 to configuration mode. No further operation is possible.

If the encoder was exchanged the drive will auto reset the E.ENCC fault but will remain in configuration mode because the user will need to learn the new encoder position before operation can continue. See section 5.11.1

If there is an encoder triggered fault or problems with the encoder cable the E.ENCC error will not clear and the problems must be diagnosed through parameter LF.26. To clear the E.ENCC error, it is necessary to go to parameter 0.LF.26, press "Func" and then press "Enter".

Signals Format of the analog channels

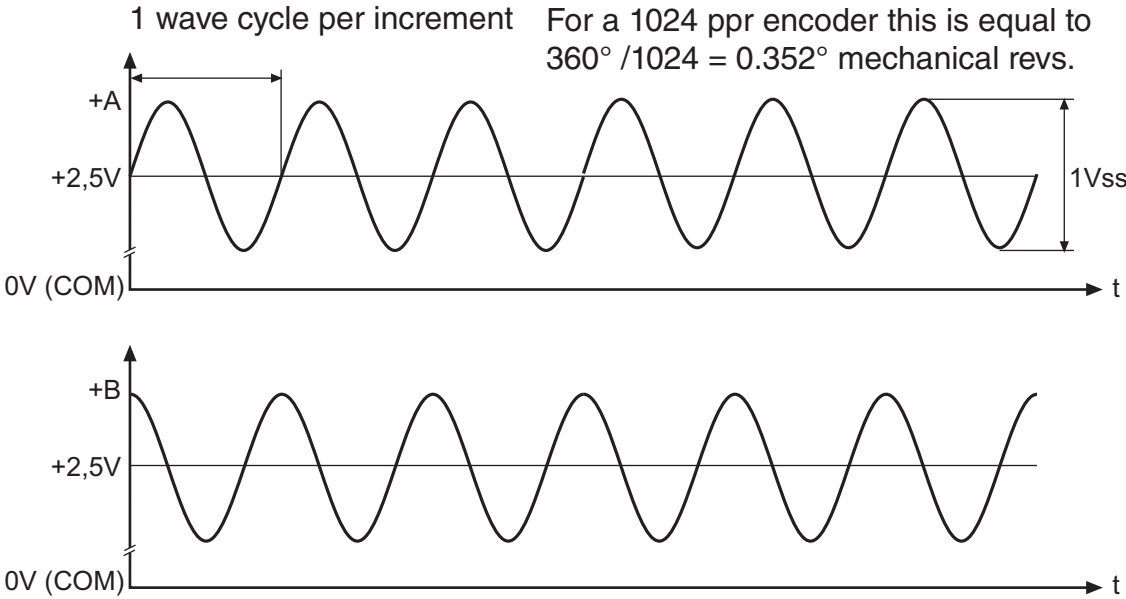

Installation and Connection

3.2.5 X3A SIN/COS-SSI Encoder

The SIN/COS-SSI encoder provides two differential analog channels for incremental position and one serial data channel with clock for communication with the encoder. This serial data channel can provide the drive with the absolute position of the motor.

The analog cosine and sine wave signals of tracks A and B have a voltage of 1 V_{pp} with an Offset of 2.5 V. This analog voltage is measured and a high resolution position value is determined as a result. This high resolution position value is very important for good speed control of a gearless motor.



Therefore it is absolutely necessary to ensure these signals are well shielded! Noise on the analog signals resulting from breaks in the shield or improper shield termination will result in vibration in the motor and poor ride quality.

During start-up and then every 30 ms a request is transmitted to the encoder and the absolute position is read out via serial communication. This initial readout of the absolute position provides the drive with the commutation angle for permanent magnet motors. On the very first operation of a permanent magnet motor it is necessary to synchronize the encoder position to one of the pole pairs of the motor. See parameter LF.77 for more information and section 5.11.1.

During normal operation, the difference between the internal absolute position of the encoder and the measured position value in the drive is compared. If the two deviate by more than 2.8 degrees, the drive will trigger the error, E.ENCC. Refer to parameter LF.26 for more information.

The clock signal serves as synchronisation for the serial data channel.

If there is an excess length of cable (10 feet or less), it is OK to coil it into a loop in the controller. Maintain a minimum diameter of 1 foot and keep the cable at least 8 inches away from all high voltage power wires.

Installation and Connection

Drive connection X3A Female SUBD 15 HD

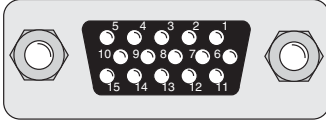

Pin No	Signal Description
1	- -
2	- -
3	REF_COS signal input A- (difference signal to COS+)
4	REF_SIN signal input B- (difference signal to SIN+)
5	- -
6	+ CLOCK synch. signal for serial data
7	- CLOCK synch. signal for serial data
8	COS+ signal input A (absolute track for counter and direction detection)
9	SIN+ signal input B (absolute track for counter and direction detection)
10	- -
11	- -
12	+ 5V Supply voltage for encoder
13	COM Reference potential for supply voltage
14	-DATA Data channel RS485
15	+DATA Data channel RS485

Max. Load Capacity depending on Voltage Supply

Max. load capacity at +5.0V; 300 mA. The specified current is reduced by the current taken from the second encoder interface X3B interface (see section 3.2.6).

SIN/COS-SSI Cable

Pre-manufactured SIN/COS-SSI cables offer the best solution against noise and disturbance while at the same time saving installation time. The cables come in standard lengths of 5m, 10m, 15m, 20m, 25m and 30m.

Cable Part Number

00.F5.0C1-40xx xx = length in meters, 10 = 10 meters

Mating Connector

00.90.912-004U for encoder (solder type)

Running in Conduit

When this cable must be pulled through metallic conduit, it is necessary to over size the conduit! Use of a 1 1/2 inch trade size conduit will allow the connectors to pass without removal of the connectors. Cutting the cable, or removal of the connectors or their housings voids the warranty and will result in problems with electrical noise after the fact.

Circular connector on Sin/Cos-SSI encoder.

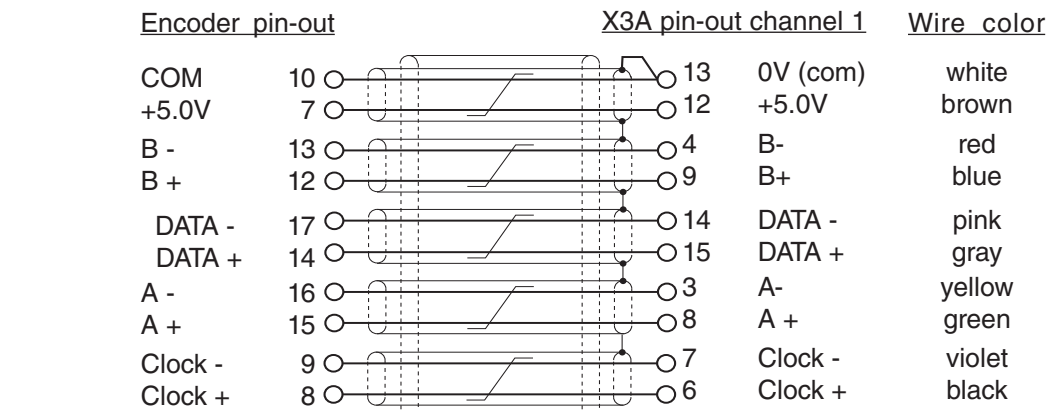
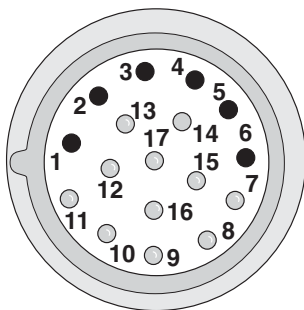

Shield wire tied to housing Shield wire tied to housing
Note: Inner pair shields are tied to 0V (com), which is earth ground.

pin 13, not earth ground!

Installation and Connection

Technical Data

Input resistance:	120 Ohm
Process data channel:	1Vpp
Parameter channel:	EIA RS485 half duplex
Clock signal output:	EIA RS485
Maximum input frequency:	200 kHz
Encoder line number:	1...2048 inc
Maximum cable length:	100 m (<i>based on signal levels, otherwise see below</i>)
Cable length based on cable resistance	

The maximum cable length is calculated as follows:

$$\text{Length} = \frac{V - V_{\min}}{I_{\max} * R} = \frac{5.25V - 4.75V}{0.2A * 0.003 \Omega/m} = 83.3 \text{ m}$$

where

I_{\max} = supply current of encoder [amps]

V = voltage supply of the drive = 5.25V

V_{\min} = minimum supply voltage of the encoder

R = cable resistance (0.07 Ω/m) for Standard KEB cables
(0.03 Ω/m) for type "L" KEB cables

The following SIN/COS-SSI encoders have been tested for use:

- Danaher / Hengstler

However, this does not restrict the use of rotary encoder with same specifications of other manufacturers

The recognition of encoder loss or exchange is a software function and dependent on the encoder type. If the drive senses that the serial communication to the encoder has stopped, it will trigger the error E.ENCC.



If the encoder is replaced or disconnected, the drive will trigger an error or warning that the encoder was changed. The drive will display the error message E.ENCC and lock out operation by changing LF.3 to configuration mode. No further operation is possible.

If the encoder was exchanged the drive will auto reset the E.ENCC fault but will remain in configuration mode because the user will need to learn the new encoder position before operation can continue. See section 5.11.1

If there is an encoder triggered fault or problems with the encoder cable the E.ENCC error will not clear and the problems must be diagnosed through parameter LF.26. To clear the E.ENCC error, it is necessary to go to parameter 0.LF.26, press "Func" and then press "Enter".

Signals Format of the analog channels

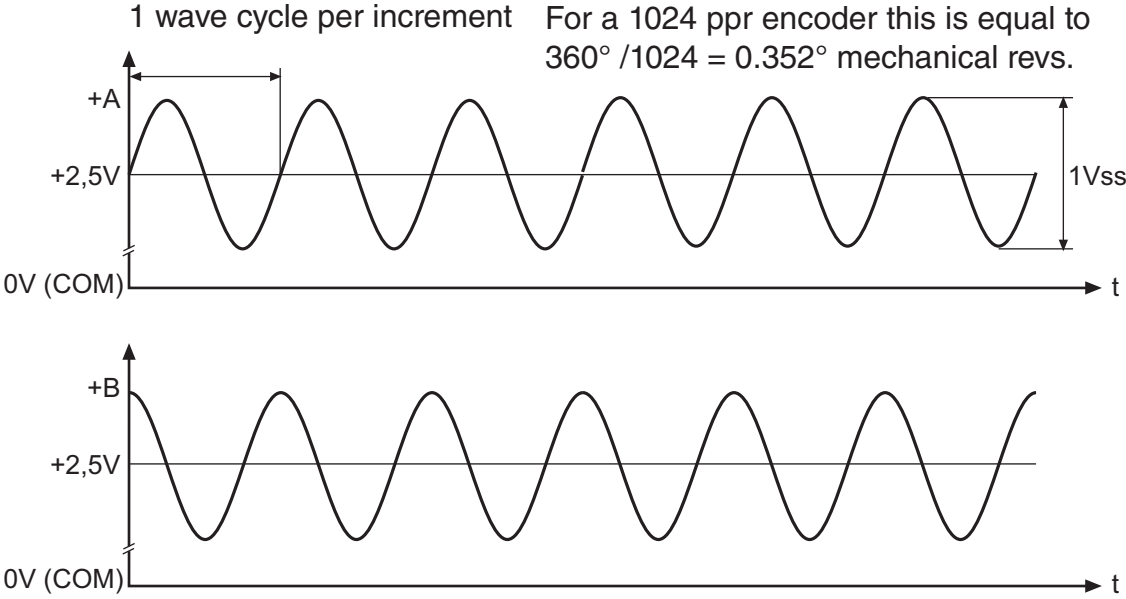

Installation and Connection

3.2.6 X3B Incremental Encoder Output



ONLY when the inverter is switched off and the voltage supply is disconnected may the feedback connectors be removed or connected!

The second incremental encoder connection serves as a buffered output of the motor encoder. This can be used by other control systems for speed or position control. The output signals are according to the RS422 line driver signal standard.

9 Pin Sub D - Female

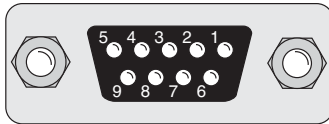

Plug in screw terminal



Pin No.	Signal	Pin No.
1	A+	1
2	B+	3
3	N+	5
4	+5.0 V	7
5	24...30 V	-
6	A-	2
7	B-	4
8	N-	6
9	0V com	8
Sub-D Housing	Earth GND	Inverter Housing

The internal 24VDC power supply has a maximum load capacity of 170mA . The 5V supply has a maximum load capacity of 500mA. Both of these values assume no loading on the supplies of connection X3A. If connections or loads are placed on both terminals, the total load between the two must not exceed these values.

The following specifications apply to encoder interface X3B, channel 2

- Max. operating frequency: 200 kHz.
- Maximum cable length: 50m (164 ft)
- External terminating resistance: $R_t = 120 \text{ W}$
- RS422 or TTL level square wave voltage level: 2...5 Vdc



For proper noise immunity, the RS422 standard requires a termination resistor be placed at the device which is receiving the simulated encoder signal. The resistors shall be connected from A+ to A-, B+ to B-, N+ to N- (only when used).

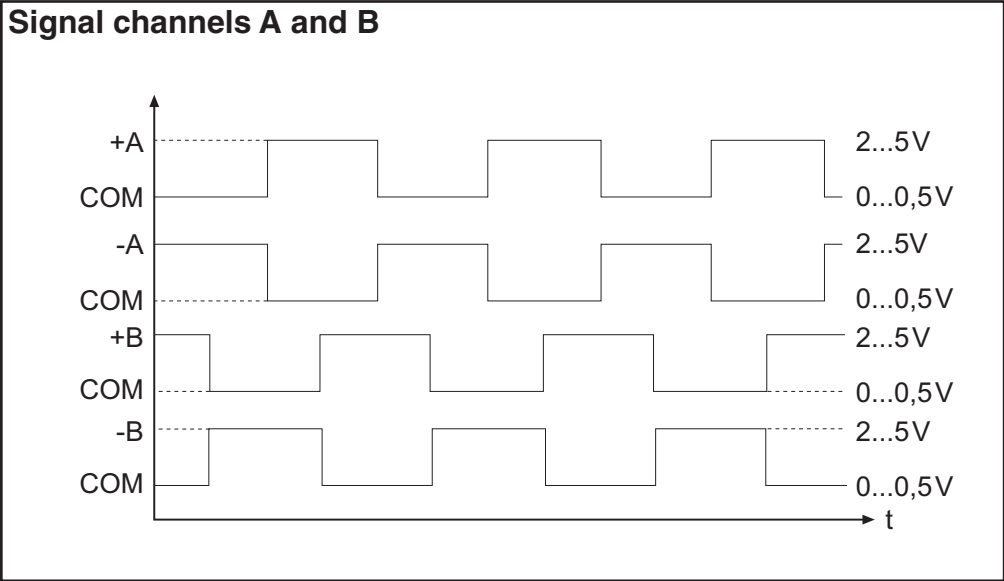

4. Operation of the unit

4.1 Digital Operator

The Elevator drive uses a special operator which provides a user interface and functionality specific to elevator applications. The operator must be plugged into the drive in order for the drive to function correctly.



Unplugging the operator while the drive is in operation will result in immediate shutdown of the drive and will cause the ready relay to drop and the fault output to activate. If it is necessary to remove the operator, do so while the elevator is standing still!

Elevator Operator: Part No. 00.F5.060-2029

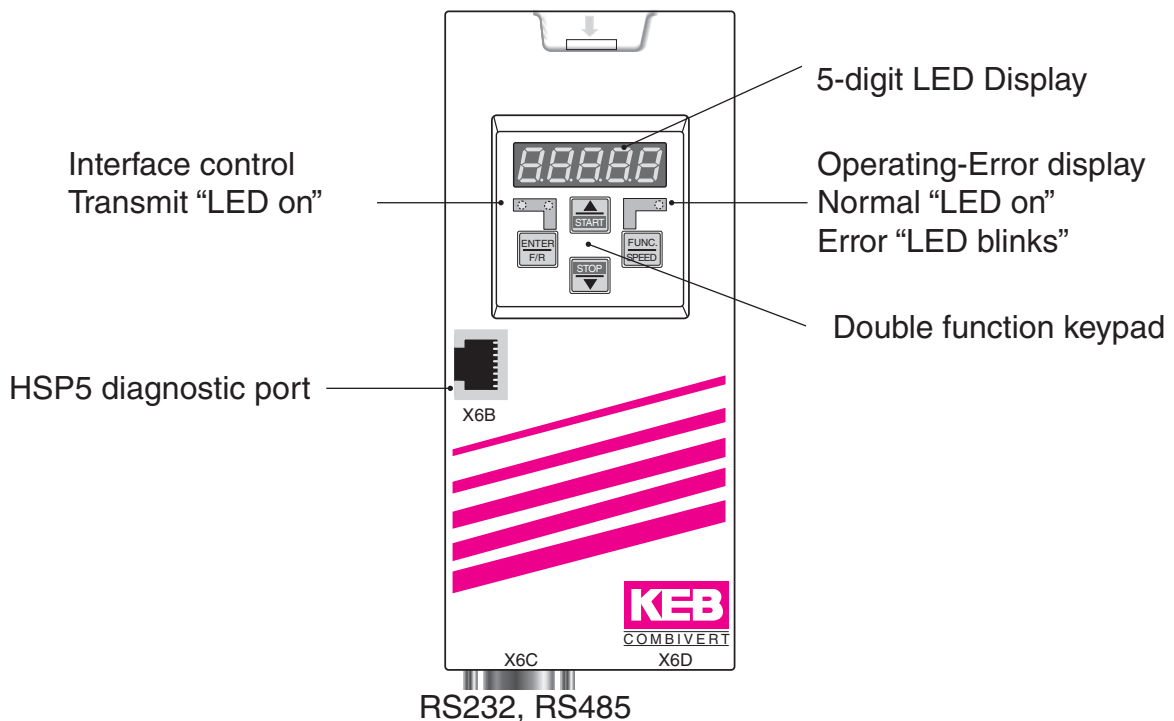

Use only the **operator interface X6C** for the serial data transfer using RS232, or 485. The direct connection from PC directly to the Elevator Drive without operator or using the HSP5 diagnostic port is only possible with a **special cable**. Incorrect cabling can lead to the destruction of the PC-interface. Consult the factory for more information.

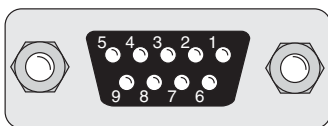

X6C
RS232, RS485

PIN	RS485	Signal	Meaning
1	–	–	reserved
2	–	TxD	Transmitter signal, RS232
3	–	RxD	Receiver signal, RS232
4	A'	RxD-A	Receiver signal A, RS485
5	B'	RxD-B	Receiver signal B, RS485
6	–	VP	Voltage supply-Plus +5V ($I_{\max} = 10 \text{ mA}$)
7	C, C'	DGND	Data reference potential
8	A	TxD-A	Transmitter signal A, RS485
9	B	TxD-B	Transmitter signal B, RS485

4.2 Parameter Identification

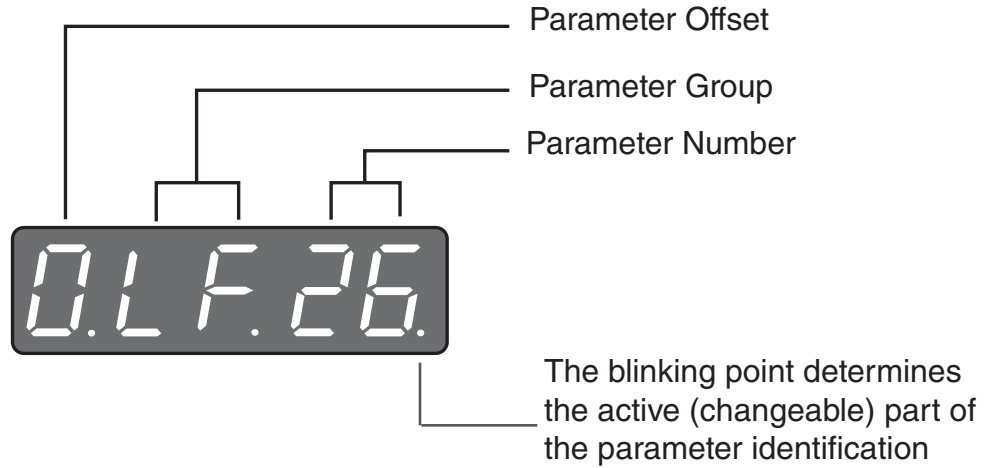

4.3 Parameter Selection

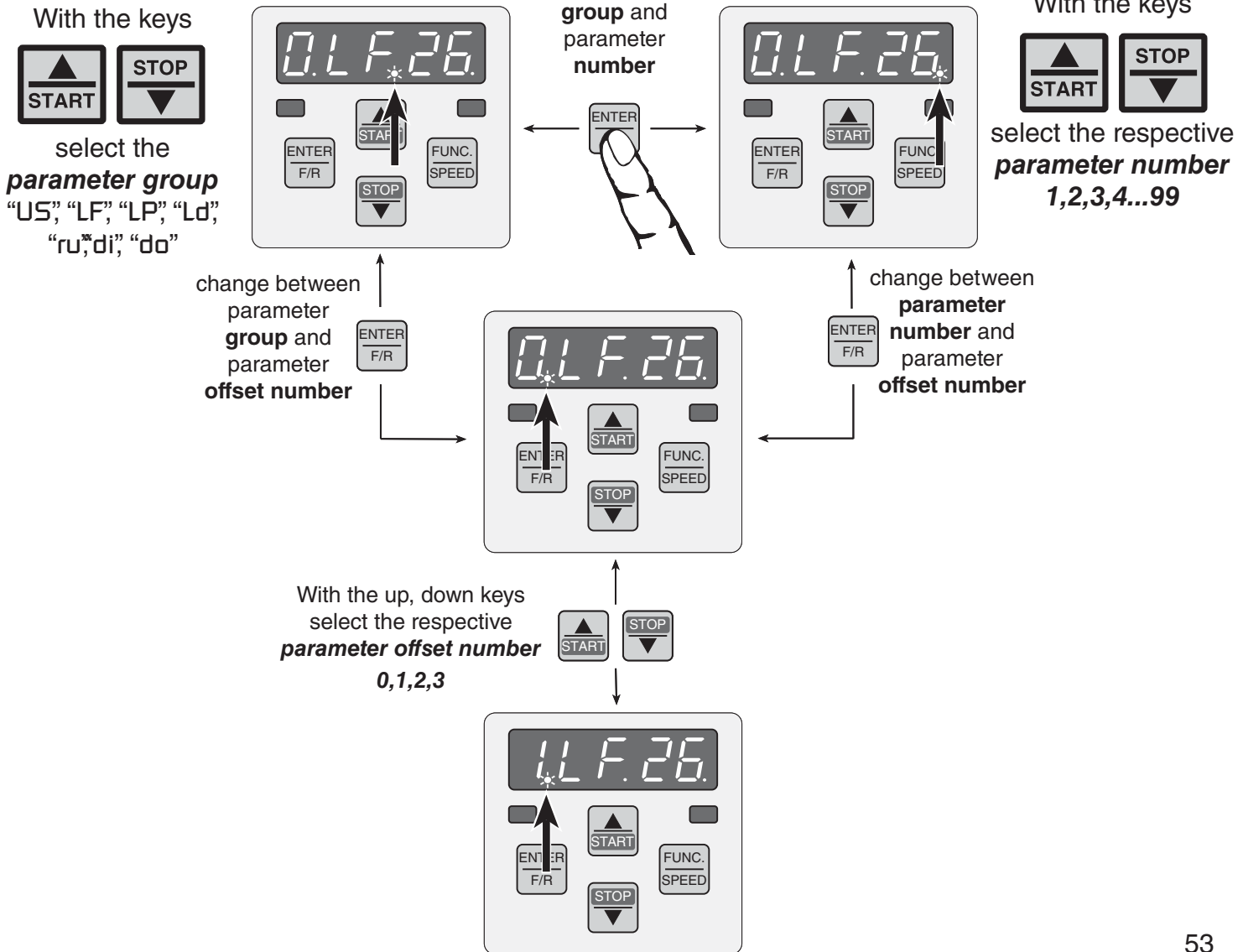

Keypad Display

4.4 Changing Parameter Values

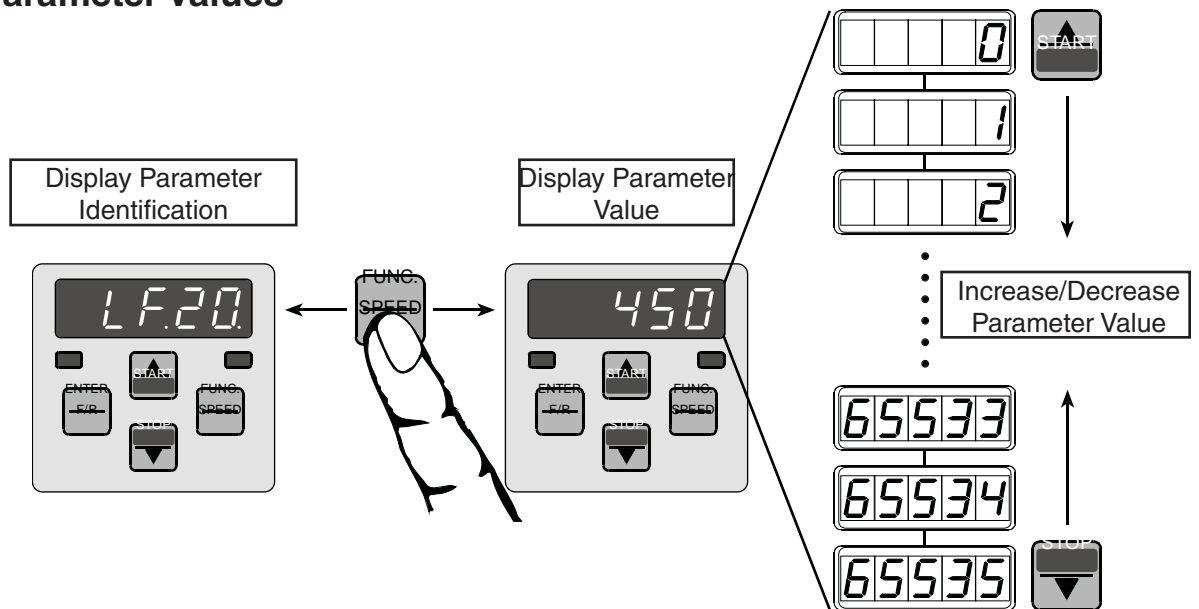

Changing Parameter Values

All parameter changes are accepted for operation and saved only after the ENTER key is pressed.

Some parameters, such as the motor data, can not be changed while the elevator is in operation.

4.5 Parameter Structure

LF-Parameter: LF. 2 ... LF.99

These parameters allow the user to program the drive for the given job specifications: motor data, mechanical data, speeds, profiles, etc.

LP-Parameter LP.1...LP.23

These parameters are used to configure the positioning control.

Ld-Parameter Ld.18...Ld.33

These parameters are used to configure the advanced controllers within the drive.

US-Parameter: US. 1 ... US.10

The US parameters are comprised of configuration parameters: parameter value reset, selection of operation mode, password entry, etc.

ru-Parameter: ru.0 ... ru.83

The ru parameters are comprised of run parameters for monitoring operation, i.e. actual values for many internal parameters

do-Parameter: do.42 ... do.83

The do parameters are comprised of parameters for defining the output functions

di-Parameter: di.0 ... di.3

The di parameters are comprised of parameters for defining the input functions

4.6 Saving Parameter Values

If the parameter value is changed, a point appears behind the last position in the display. The adjusted parameter value is permanently saved when **ENTER** is pressed. The point after the value disappears to confirm.

Example:

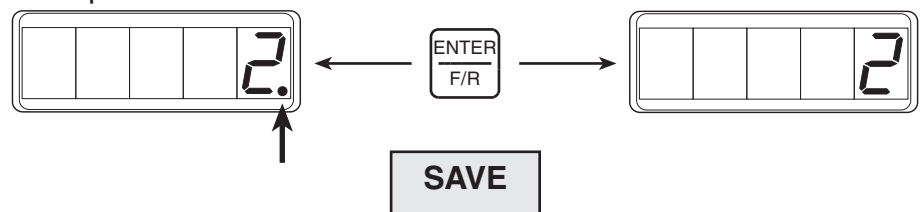

4.7 Error Messages

If a malfunction occurs during operation, the drive shuts down operation and the actual display is overwritten with the error message. By pressing the “ENTER” key, the error message and the fault status is cleared. Exception: E.ENCC errors, see parameter LF.26 for E.ENCC errors.

Example:

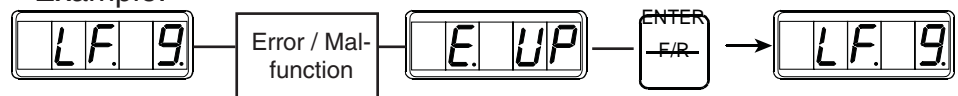

Some errors are automatically reset according to the adjustment of parameter LF.5. So it is possible that the error message and the error status of the drive will clear on its own. Refer to parameter LF.98 for the fault history.

***Inverter Status Message
(running/error message) see p. 134***

5. Initial Start-up

5.1 Selecting The Configuration

Before trying to operate the drive it is necessary to establish the correct mode of operation. The F5 drive is capable of driving different types of motors both open and closed loop. Therefore prior to operation, the type of motor and mode of operation (open or closed loop) must be established.



Note: In most cases the elevator control manufacturer will make the adjustment of the configuration and control mode, sections 6.1 and 6.2, and therefore it is not necessary to make these adjustments in the field. In this case simply verify parameter LF.4 matches the required configuration number listed below.

The available motors and modes or configurations are listed below. From this list it is possible to select the correct configuration setting of the Drive.

Motor Type	Open Loop	Closed Loop	Configuration Display Code
Induction Geared	-	x	ICL5d
Induction Gearless	-	x	I9L55
PM Synchronous Geared	-	x	PCL5d
PM Synchronous Gearless	-	x	P9L55

5.2 Loading The Configuration

With the configuration code noted, go to parameter US.10 on the keypad of the drive and press “Function.” Select the configuration code indicated and press “Enter.”

Once the configuration is selected, it is now necessary to load the configuration file. This adjusts the drive for the correct motor type and establishes the correct internal settings.

To load the configuration go to parameter US.04, set the display to LoAd and press enter. The display will show Pr09 and the configuration file will be loaded. The display will confirm whether the load was successful. If the display ultimately changes to parameter LF.99 and shows noP, the load was successful. If the file is not completely loaded, the display will show bdPAS for bad operation and will remain at parameter US.4. In this case power cycle the drive and try to load the configuration again. Make sure that no inputs are active while trying to load the configuration. LF.82 should read 0. If still unsuccessful there may be an incompatibility between the operator and the drive. Contact the manufacturer for further assistance.

After loading, the configuration can be verified through parameter LF.4. The same configuration code as that selected in US.10 will be displayed in LF.4. Also after a successful load US.4 will display PAS5.

5.3 Setting The Control Type

The COMBIVERT drive supports six different control modes, digital speed selection and control, analog speed control, analog torque control. The drive's I/O will need to be set up according to the desired scheme. From the table below select the desired control scheme and adjust the corresponding number in parameter LF.2.

Control Mode	Setting in LF.2
Absolute Analog Speed Control	RbSPd
Digital Speed Selection	d SPd
Analog Speed Control	A SPd
Analog Torque Control	A tor
Serial Com. Speed Control	SErSP
Binary Speed Selection	bnSPd

5.4 Entering The Operating Data

The COMBIVERT drive utilizes robust algorithms for controlling the motor, therefore even with minimum information about the motor, good performance can still be achieved. However a few basic parameters are required. Their adjustment is outlined below. For purposes of identifying the type of motor in use the following convention will be utilized in this manual. AC induction motors will be referred to as "IM" and AC permanent magnet synchronous motors will be referred to as "PM".

Before you begin to enter the motor data verify that parameter LF.3 is set to conF configuration.

The COMBIVERT Drive is capable of driving either induction motors, referred to from here on as "IM" or permanent magnet motors referred to from here on as "PM".

Verify in LF. 4 that the correct motor configuration is loaded and then follow the steps listed below based on what type of motor you have.

5.5 Induction Motors

5.5.1 Motor Overload

The COMBIVERT drive is capable of providing solid state motor overload protection. If it is desired that the drive provide this protection, turn the function "on" in parameter LF.08. Then adjust the motor full load amps (FLA) in parameter LF.09. Enter the IM power (hp) in LF.10.

Initial Start Up

5.5.2 Induction Motor Data

Enter the motor rated speed (rpm) in LF.11. For IM this value is not the synchronous speed but the full load rpm which is always less than synchronous speed. An example is a 6 pole motor; the synchronous speed is 1200 rpm but the rated speed is lower, about 1165 rpm. If the rated speed is not listed on the nameplate then the value can be approximated as the synchronous speed less 2.9%, so $1200 \text{ rpm} - 35 \text{ rpm} = 1165 \text{ rpm}$.

Enter the rated FLA of the motor in parameter LF.12.

Enter the rated nameplate frequency in parameter LF.13. In some cases manufacturers of induction motors de-rate the motor by changing the frequency to something less than 60hz, i.e. 40Hz. In this case enter the nameplate value of 40Hz. Most gearless motors will have a very low frequency in the range of 8 to 30 Hz. Enter the frequency as indicated on the motor nameplate.

In LF.14 enter the rated motor voltage. For IM this is the AC voltage at the rated frequency, i.e. 230V or 480V.

The IM power factor can be entered in LF.15. If this value is not known use the default value of 0.90. This parameter sets the pre control for the magnetizing current level. Higher values result in lower magnetizing current. For older existing high slip or two speed motors use a value of 0.95.

The field weakening speed in LF.16 is calculated by the drive. It may be necessary to adjust it later once the elevator is in operation and running at high speed. For now leave it at the calculated value.

LF.17 is the motor rated torque. With IM this value is calculated and is only for reference.

Entry of the IM motor data is now complete!

5.5.3 Auto-Tuning Induction Motors

For best performance the motor model of the induction motor must be measured by the drive. Use the following steps to complete the measurement for induction motors.

Set up

- 1) Make sure the rated motor power (LF.10), rated motor speed (LF.11), rated motor current (LF.12), rated motor frequency (LF.13), rated motor voltage (LF.14) and rated power factor (LF.15) are entered into the drive before you begin. If the power factor is not on the name plate use 0.90 as the value.
- 2) Remove one brake wire from the controller or reduce the brake pick voltage level, preventing it from picking.

- 3) If the controller is providing the speed command via analog or serial command, set the inspection speed value in the controller to zero. If the drive is providing the command there is no need to change the inspection speed in the drive.



Scan the QR code above to view a walkthrough video of the S Lrn procedure.

Learn Process

- 1) Set LF.3 = 5 Lrn. This will start the learn process.
- 2) The display will change to StArt.
- 3) Press and hold inspection up. The motor contactor should pull in and the brake should not pick. Motor current will begin to flow, an audible noise in the motor will be heard, and the drive display will change to LS103 .
- 4) The drive will measure various parameters in the motor as well as in the drive's own power stage. During each measurement the display will change to signify what is being measured. In the event of problems during the measurement phase the factory can use the codes to determine what is happening.
- 5) Continue holding the inspection switch ON until the drive displays done.
- 8) Release the inspection switch, the drive will finish by making several calculations, CALC, and updating the parameters values with the measured values.

AUTO TUNE COMPLETE!



FAIL: the measurement sequence was interrupted, i.e. the inspection switch was released prematurely, electrically the motor was not properly connected, or the controller dropped the enabled signal to the drive. Verify if the controller is dropping the signal by first setting LF.3 to conf and try again. If the controller still drops the enable and the motor contactor, the problem lies in the controller.

FAILE: Drive fault occurred during learn process. See last drive fault 0.LF.98 and diagnose.

FAILd : the drive is not able to begin measurements due to a configuration error. Consult the factory to resolve.

E.cdd: the measurement of one of the motor parameters was not possible. Repeat the process and note what code is displayed just before the error occurs. Then contact the manufacture for assistance. In some cases the error can be avoided by preadjusting some motor data.



**Remember to put the drive back into run mode in LF.3 and return the controller adjustments to the previous values!
Reconnect the brake wire!**

Initial Start Up

5.6 PM Synchronous Motors

5.6.1 Motor Overload The COMBIVERT drive is capable of providing solid state motor overload protection. If it is desired that the drive provide this protection, turn the function “on” in parameter LF.08. The drive uses the motor current from LF.12. As the trigger level.

5.6.2 Motor Data Depending on the motor manufacturer and the installed encoder, it may be possible to read all motor data from the encoder and preset all data to the manufacturer’s values therefore eliminating the need to adjust the motor data. Refer to section 5.8.3 for a description of this process. Otherwise proceed with the adjustment steps below.

The PM motor power (hp) in LF.10 is calculated from the speed (LF.11) and torque (LF.17). This value is for reference only.

Enter the motor rated speed (rpm) in LF.11. Note in some cases this speed may be faster than the actual speed the motor will turn at. This parameter must agree with parameters LF.13 based on the following equation. Do not round the numbers enter exactly what is calculated.

$$\frac{\text{Rated Freq.} \times 120}{\text{no. of poles}} = \text{Rated Speed}$$

Enter the rated FLA of the motor in parameter LF.12.

Enter the rated nameplate frequency in parameter LF.13. Again refer to the calculation above. Do not round this value enter exactly what is calculated.

In LF.14 enter the rated, no load, motor back EMF rms phase to phase voltage. Follow the steps in section 5.6.3 to measure this value.

LF.17 is the motor rated torque. For PM motors enter the rated motor torque in lbft. If this value is not listed on the motor you can calculate it as follows.

$$\frac{\text{HP}}{\text{rpm}} \times 5258 = \text{lbft} \quad (\text{HP and rpm from motor nameplate})$$

$$\frac{\text{KW}}{\text{rpm}} \times 7043 = \text{lbft} \quad (\text{KW and rpm from motor nameplate})$$

LF.18 is the motor stator phase to phase resistance. Follow the steps in section 5.6.3 to measure this value.

LF.19 is the motor stator leakage inductance. Follow the steps in section 5.6.3 to measure this value.

Entry of the PM motor data is now complete!

5.6.3 Auto-Tuning PM motors

For best performance the resistance and the inductance of the PM motor must be measured by the drive. Use the following steps to complete the measurement for PM synchronous motors.

Set up

- 1) Make sure the rated motor speed (LF.11), rated motor current (LF.12), rated motor frequency (LF.13), rated motor torque (LF.17) and contract speed (LF.20) are entered into the drive before you begin.
- 2) Remove one brake wire from the controller or reduce the brake pick voltage level, preventing it from picking.
- 3) If the controller is providing the speed command via analog or serial command, set the inspection speed value to zero in the controller to zero. If the drive is providing the command there is no need to change the inspection speed in the drive.

Learn Process

- 1) Set LF.3 = 5 Lrn. This will start the learn process.
- 2) The display will change to StArt.
- 3) Press and hold inspection up. The motor contactor should pull in and the brake should not pick. Motor current will begin to flow, an audible noise in the motor will be heard, and the drive display will change to L5103 .
- 4) The drive will measure various parameters in the motor as well as in the drive's own power stage. During each measurement the display will change to signify what is being measured. In the event of problems during the measurement phase the factory can use the codes to determine what is happening.
- 5) Continue holding the inspection switch ON until the drive displays done.
- 8) Release the inspection switch, the drive will finish by making several calculations, CALC, and updating the parameters values with the measured values.

AUTO TUNE COMPLETE!



Scan the QR code above to view a walkthrough video of the S Lrn procedure.



**Remember to put the drive back into run mode in LF.3 and return the controller adjustments to the previous values!
Reconnect the brake wire!**



Errors: In the event the drive can not complete the measurements three error messages may occur.

FAILE: Drive fault occurred during learn process. See last drive fault 0.LF.98 and diagnose.



FAIL : the measurement sequence was interrupted, i.e. the inspection switch was released prematurely, or the controller dropped the enable signal to the drive. Verify if the controller is dropping the signal by first setting LF.3 to conf and try again. If the controller still drops the enable and the motor contactor, the problem lies in the controller.

E.cdd: the measurement of one of the motor parameters was not possible. Repeat the process and note what code is displayed just before the error occurs. Then contact the manufacture for assistance. In some cases the error can be avoided by preadjusting some motor data.

FAILd: the drive is not able to begin measurements due to a configuration error. Consult the factory to resolve.

5.7 Machine Data

It is necessary to enter the machine data such that the drive can establish the relationship between linear travel, ft/min and rotary speed in rpm at the motor.

Enter the job contract speed in parameter LF.20.

Then enter the sheave diameter in LF.21. If this value is not known, it can be measured with a tape measure. Some sheave manufacturers will show the “Minimum Groove Diameter” on a plate attached to the sheave. This is the diameter to the bottom of the groove, which is normally about one inch smaller than the actual diameter at which the rope lies. Therefore, when this dimension is provided, add one inch to it and enter that value into LF.21.

LF.22 is the machine gear ratio. It is often listed on the machine as a ratio of gear teeth such as 55:2. In this case divide the ratio ($55/2 = 27.5$) and enter the value. If the ratio is not known, skip ahead to LF.23 and then see LF.25 for an estimated gear ratio which can be entered into LF.22. Remember for gearless jobs the gear ratio is 1.00.

LF.23 is the roping ratio. For most geared applications it is 1:1. For gearless application the rope ratio is typically 2 but can be higher.

LF.24 is the car rated capacity in lbs.

LF.25 is the estimated gear ratio. If the gear ratio is not known, take the value from LF.25 and enter it into LF.22.

Set up for the machine is complete!

5.8 Encoder Feedback

Parameters LF.26...LF.29 and optionally parameters LF.76 and LF.77 are used to establish the encoder feedback.

5.8.1 Encoder card verification

The most important point is to verify that the installed feedback card matches the encoder type on the motor. The drive supports many different types of encoders, some of which require different feedback cards as options. Parameter 0.LF.26 displays the type of encoder feedback card which is currently installed. From the list below verify the encoder interface on the drive matches the encoder on the motor.

0.LF.26	Type of encoder card installed in the drive
rESoL	Resolver
HIPEr	Hiperface
Inc24	15-24V HTL incremental
IncIE	5V TTL incremental
SinCo	Sine Cosine
I24PE	15-24V HTL incremental
EndAt	EnDat Encoder
PHASE	UVW Encoder

5.8.2 Encoder serial com. verification

ENDAT, HIPERFACE, and SIN/COS-SSI encoders support serial communication between the encoder card on the drive and the encoder. This serial communication transmits the digital position value and well as other data about the motor and the encoder. The encoder can trigger faults and advise the drive of the problem. Therefore with these types of encoders it is necessary to verify that serial communication is functioning normally. Parameter 2.LF.26, displays the status of the encoder / encoder interface. When everything is functioning normally the display will show `conn`. If there is an error, the drive will first stop operation with an E.ENCC error and then will display the encoder error code from 2.LF.26 and then a text message representing the code. All diagnostics of the encoder interface should be handled through parameter 2.LF.26. For more information refer to parameter LF.26.

Initial Start Up

5.8.3 Other encoder adjustments

Enter in LF.27 the pulses per revolution of the encoder, i.e. 1024, 2048, 4096 etc.

LF.28 can be used to swap the encoder channels such that the encoder is incrementally counting in the same direction as the motor. Initially leave this parameter set to 0 or no reversal. Whether or not reversal is necessary will be determined later in section 5.11

LF.29 sets the sample time for the speed measurement. Initially the default setting of 4 mSec will work fine.

Set up of the encoder is complete!

5.9 Controller Settings

The speed and torque controller are adjusted in parameters LF.30 through LF.33, and LF.36. For initial start up the default settings will work. Once the elevator is running at high speed, it might be necessary to come back to adjust LF.31...LF.33. Parameters Ld.27 and Ld.28 are adjusted automatically by the drive and should require no adjustment by the user.

LF.30 is the one parameter which will need to be adjusted for initial operation. If operating open loop set LF.30 = 0 and if operation is closed loop speed or torque control initially set LF.30 = 2. Once the proper direction of rotation is established LF.30 can be changed to a value of 4 if torque control is ultimately desired.

Set up of the controller is complete!

5.10 Speed and Profile Settings

The speeds are adjusted through parameters LF.41...LF.47. The profile is adjusted through parameters LF.50...LF.56.

When operating with digital speed selection and control, each speed must be adjusted respectively.

LF.41 = Leveling speed	LF.42 = High speed
LF.43 = Inspection speed	LF.44 = high leveling speed
LF.45 = intermediate speed 1	
LF.46 = intermediate speed 2	
LF.47 = intermediate speed 3	

The default settings listed on page 112 for the profile parameters LF.50...LF.56 are a good place to start. When operating with analog speed or torque control, only high speed must be adjusted to the contract speed value. In selecting analog control in parameter LF.2, the profile generator in the drive is automatically turned off.

Set up of the speeds and profiles are complete!

5.11 Running the Motor

5.11.1 Stationary Pole Identification (SPI)

The SPI function allows the drive to learn the absolute encoder position for a PM machine under the brake without sheave movement.



The SPI process can be done with the ropes on and the brake set.

This procedure can only be done with a Permanent Magnet Motor. Depending on the motor design, the SPI process may fail. In this case see section 5.11.2.

Before the drive can learn the absolute position, the motor data must be entered correctly and the motor resistance and inductance must be measured by the drive. See section 5.6.2 and 5.6.3.



Scan the QR code to the left to view a walkthrough video of the SPI procedure.

Initial Start Up

Initial Steps

- 1) Verify the motor is correctly connected to the drive, i.e. phase U->U, V->V, W->W. With PM motors you can not have an arbitrary phasing. If direction reversal is required, the system direction can be reversed in LF.28 after the pole position is learned.
- 2) Verify the correct mode of operation. LF.4 should be set to either PCL5d or P9L55. If this is not the case see parameter US.10 to change the configuration mode.
- 3) If not already done, enter the motor nameplate data and machine data in parameters LF.10 to LF.25. Learn the motor with the auto tune function, see sections 5.6.2 and 5.6.3.
- 4) Verify the correct encoder feedback card is installed in the drive. See parameter 0.LF.26. Enter the encoder ppr in parameter LF.27. Make sure LF.28 = 0 and the sample time, LF.29 = 4 (4mSec.).

Alignment Process

- 1) Prevent brake from releasing.
- 2) Set LF.3 = SPI and press "Enter". The display will confirm with StArt.
- 3) Press and hold the inspection switch up. The motor sheave should not turn and the display will show position values of the encoder. The brake should not release.
- 4) Once complete, donE will be displayed on the keypad operator. Release the inspection switch and make note of the final position number in LF.77. This position number is valid only for this motor and encoder. If the encoder is physically removed from the motor, this process will need to be done again.
- 5) The display will show noP in LF.99 and LF.3 will automatically be set to run.
- 6) Verify encoder position is correct by running the car and monitoring the current in LF.93. If the current is excessive, the encoder rotation may be incorrect. In this case change LF.28 from a value of 0 to 1 or from 1 to 0, else from 2 to 3 or from 3 to 2, and repeat the alignment process.



Errors: In the event the drive can not complete the measurement the following error messages may occur.

FAILP: The drive is not able to begin measurements due to not entering and learning the correct motor data. See section 5.6.2 and 5.6.3.

FAIL: The measurement sequence was interrupted, i.e. the inspection switch was released prematurely, or the controller dropped the enabled signal to the drive. Verify if the controller is dropping the signal by first setting LF.3 to conF and try again. If the controller still drops the enable and the motor contactor, the problem lies in the controller.

FAILd: The encoder position samples are not consistent within 4,000 counts after 11 samples. In this case try the procedure again and note the learned values. If all displayed values are consistent, it would be sufficient to use an approximate average and enter it into LF.77. Otherwise, if the positions are sporadic and not consistent, verify motor data parameters LF.11-19 then relearn the motor data with S_Lrn. If still unable to learn the encoder position with SPI, refer to section 5.11.2 to learn it with sheave movement.

FailE: A drive fault occurred during the learn process. View error in 0.Lf.98 and resolve to continue

5.11.2 Absolute Encoder Setup (no ropes)

HIPERFACE, ENDAT, SIN/COS Encoders



The following will outline the procedure for aligning an absolute encoder to the pole of a permanent magnet motor and the following encoders: Hiperface, Endat, SIN/COS. The motor must be mounted in place and be electrically connected to the elevator controller. The motor encoder must also be connected to the controller. The motor must be able to spin freely either by mechanically releasing the brake or through normal electrical release.

If at any point during the set up process, if the drive should give the error E.ENCC, the display will change automatically to 2.LF.26 and display the error code from the encoder. Refer to parameter LF.26 for further information.

Initial Steps

- 1) Verify the motor is correctly connected to the drive, i.e. phase U->U, V->V, W->W. With PM motors you can not have an arbitrary phasing. If direction reversal is required, the system direction can be reversed in LF.28 after the pole position is learned.
- 2) Verify the correct mode of operation. LF.4 should be set to either PCL5d or P9L55. If this is not the case see parameter US.10 to change the configuration mode.
- 3) If not already done, enter the motor nameplate data and machine data in parameters LF.10 to LF.25. Learn the motor with the auto tune function, see sections 5.6.2 and 5.6.3.
- 4) Verify the correct encoder feedback card is installed in the drive. See parameter 0.LF.26. Enter the encoder ppr in parameter LF.27. Make sure LF.28 = 0 and the sample time, LF.29 = 4 (4mSec.).

Alignment Process

- 1) Set LF.3 = P Lrn. The display should confirm with StArt.
- 2) Press and hold the inspection up switch. Motor current will begin to flow in one phase and the current will ramp up to the motor's rated value. The motor sheave should turn slowly and then stop when the motor rotor has lined up with one of the motor poles. The display should show

Initial Start Up

the actual position value of the encoder. As the motor moves this value will change. When the motor rotor has aligned with a pole, the value will stabilize. At this point, the alignment has been found.

Continue holding the inspection switch as the drive will then try to move the motor clockwise and counter clockwise to verify the motor's rotation is consistent with the encoder's. The motor should return to nearly the same position. Go to step 5.

If the motor keeps rotating for more than 30 seconds, the phasing between the encoder and the motor is not correct. Verify the motor connection U to U, V to V, etc. and make sure LF.28 = 0.

- 3) If the drive triggers the error E.ENC1, the encoder's counting maybe backwards. Release the inspection switch. The drive will then automatically swap the encoder channels by changing the value of LF.28 and then display retry. Go back to step 2.
- 4) If the drive displays E.ENC1 again the motor is not able to rotate freely. Release the inspection switch and verify the brake is opening completely and that there is not excessive friction. The sheave should be able to turn by hand. Verify the motor phasing U to U, V to V etc.

If it is still not possible to learn the position try the old method by setting LF.3 = conf and LF.77 to 2206.

- 5) Once the process is complete, donE will be displayed. Release the inspection switch and make note of the final position number from LF.77 in the job information. This position number is valid only for this motor and encoder. If the encoder is physically removed from the motor, this process will need to be done again.

Return to Normal Operation

- 1) Put the drive into run mode by setting LF.3 to run.
- 2) Run the motor on inspection up and down. The speed displayed in LF.89 should be stable and should match the command speed value in LF.88. Additionally the motor current in LF.93 should be near zero. If the current is not near zero (< 5 amps), the pole position may be off. Try to relearn the position by repeating the alignment process.
- 3) If the motor rotates in the wrong direction refer to section 5.11.5 to reverse the system rotation.
- 4) For high speed runs under load, it may be necessary to raise 0.LF36 to a higher value. This value should not be set to a value higher than the motor manufacturer's peak torque value, usually 2.0 to 2.4 times the motor's rated torque found in parameter LF.17.

5.11.3 Absolute Encoder Setup (with ropes)

The following will outline the procedure for aligning an absolute encoder for use with a permanent magnet motor and the following encoders: HIPERFACE, ENDAT, SIN/COS. The motor must be mounted in place and be electrically connected to the elevator controller. The motor encoder must also be connected to the drive. In this case the ropes are already on the motor.



At a certain point in the process, it will be necessary to put balanced load into the car to carry out this adjustment.

If at any point during the set up process, if the drive should give the error E.ENCC, the display will change automatically to 2.LF.26 and display the error code from the encoder. Refer to parameter LF.26 for further information.

Initial Steps

- 1) Verify the motor is correctly connected to the drive, i.e. phase U->U, V->V, W->W. With PM motors you can not have an arbitrary phasing. If direction reversal is required, the system direction can be reversed in LF.28 after the pole position is learned.
- 2) Verify the correct mode of operation. LF.4 should be set to either PCL5d or P9L55. If this is not the case see parameter US.10 to change the configuration mode.
- 3) If not already done, enter the motor nameplate data and machine data in parameters LF.10 to LF.25. Learn the motor with the auto tune function, see sections 5.6.2 and 5.6.3.
- 4) Verify the correct encoder feedback card is installed in the drive. See parameter 0.LF.26. Enter the encoder ppr in parameter LF.27. Make sure LF.28 = 0 and the sample time, LF.29 = 4 (4mSec.).

Balancing the car

The following steps are necessary if the car is not at floor level and the weights can not be loaded into the car. Therefore it is necessary to drive the car to a floor.

- 1) Adjust parameter 0.LF.36 equal to LF.17.
- 2) Set the inspection speed to a relatively low value 10-15ft/min.
- 3) Adjust parameter LF.77 to 16,000.
- 4) Try to run the car on inspection up or down. Note: the motor will make a loud noise and the control of the motor will be poor.
- 5) If the car fails to move go back to step 3 and change the value to 32,000, 48,000, or 64,000. Try to move the car again after each value.
- 6) Once you find a value which gives some movement you may need to add or subtract 8,000 to increase the torque output of the motor (i.e. you can move a little but the motor does not seem to have enough torque).
- 7) At this point if there is a long distance to cover in the hoist way, the inspection speed can be raised to a higher value.

Balance the car such that when the brake opens, the car does not move at all. It might be necessary to let the car drift until it reaches an equilibrium.

Initial Start Up

Alignment Process

- 1) Set LF.3 = P Lrn. The display should confirm with StArt.
- 2) Press and hold the inspection up switch. Motor current will begin to flow in one phase and the current will ramp up to the motor's rated value. The motor sheave should turn slowly and then stop when the motor rotor has lined up with one of the motor poles. The display should show the actual position value of the encoder. As the motor moves this value will change. When the motor rotor has aligned with a pole, the value will stabilize. At this point, the alignment has been found.

Continue holding the inspection switch as the drive will then try to move the motor clockwise and counter clockwise to verify the motor's rotation is consistent with the encoder's. The motor should return to nearly the same position. Go to step 5.

If the motor keeps rotating for more than 30 seconds, the phasing between the encoder and the motor is not correct. Verify the motor connection U to U, V to V, etc. and make use LF.28 = 0.

- 3) If the drive triggers the error E.ENC1, the encoder's counting maybe backwards. Release the inspection switch. The drive will then automatically swap the encoder channels by changing the value of LF.28 and then display retry. Go back to step 2.
- 4) If the drive displays E.ENC1 again the motor is not able to rotate freely. Release the inspection switch and verify the brake is opening completely and that there is not excessive friction. The sheave should be able to turn by hand. Verify the motor phasing U to U, V to V etc.

If it is still not possible to learn the position try the old method by setting LF.3 = conf and LF.77 to 2206.

- 5) Once the process is complete, donE will be displayed. Release the inspection switch and make note of the final position number from LF.77 in the job information. This position number is valid only for this motor and encoder. If the encoder is physically removed from the motor, this process will need to be done again.

Return to Normal Operation

- 1) Put the drive into run mode by setting LF.3 to run
- 2) Run the motor on inspection up and down. The speed displayed in LF.89 should be stable and should match the command speed value in LF.88. Additionally the motor current in LF.93 should be near zero. If the current is not near zero (< 5 amps), the pole position may be off. Try to relearn the position by repeating the alignment process.
- 3) If the motor rotates in the wrong direction refer to section 5.11.5 to reverse the system rotation.

- 4) For high speed runs under load, it may be necessary to raise 0.LF.36 to a higher value. This value should not be set to a value higher than the motor manufacturer's peak torque value, usually 2.0 to 2.4 times the motor's rated torque.

5.11.4 Absolute Encoder Position Verification

Verification of the encoder position following the P Lrn procedure.

Friction and the inertial load of the cab and counter weights can lead to a small error in the actual position value. The following procedure will verify whether the position is correct or not.

- 1) Set 0.LF.36 = to two times LF.17.
- 2) Pick two floors in the middle of the shaft which are far enough apart such that the car reaches contract speed.
- 3) Run the car between these floors and monitor LF.94 (peak phase current). Note the peak value for both the up and down run. The stored maximum value is cleared by pressing the down arrow. Make several runs to establish the average value in each direction.
- 4) Add 2000 to the value in LF.77 and run the car again between the same two floors. If the current value goes down then go to step 5. If the current value goes up go to step 6.
- 5) Add 2000 more to the value in LF.77 and run the car again. If the peak current in LF.94 goes down further, add 2000 more and try again. Keep doing this until the motor current begins to rise again. The value with the lowest current is the best value. Jump to step 7.
- 6) If the current went up initially, then lower LF.77 by 2000 and run the car again. If the peak current in LF.94 goes down further, subtract 2000 more and try again. Keep doing this until the motor current begins to rise again. The value with the lowest current is the best value.
- 7) Return the value of LF.77 to the value which gave the lowest current. Make note of this value in the job information for future reference.

Initial Start Up

5.11.5 Encoder Synchronization

TTL, HTL, SIN/COS Encoders with induction motors

It is necessary to determine whether or not the motor encoder is in phase with the rotation of the motor. As an example the motor is turning clockwise and the encoder is indicating clockwise rotation. The problem comes when the encoder indicates rotation opposite to the actual rotation of the motor. Depending on whether the system is operating in speed control mode or torque control mode it will be necessary to follow one of the following two procedures.

Speed Control, LF.30 = 2

To determine whether or not the encoder is aligned with the motor run the car on inspection in both the up and down direction. If the motor turns out of control, at the wrong speed, or the current going to the motor (see LF.93) is greater than the motor FLA, the encoder is reversed. This can be corrected by adjusting parameter LF.28 from 0 to 1.

Run the car again in both the up and down direction. The motor should now be running in a controlled manner but possibly in the wrong direction, meaning up inspection drives the car down or down inspection drives the car up. Parameter LF.28 can also be used to correct this. If LF.28 = 0 then change the value to 2. If LF.28 = 1 then change the value to 3. Now the motor should be controlled and run in the correct direction.

Torque Control, LF.30 = 4

To determine whether or not the encoder is aligned with the motor run the car on inspection in both the up and down direction. If the motor turns out of control, at the wrong speed, or the current going to the motor (see LF.93) is greater than the motor FLA, the encoder is reversed. This can be corrected by adjusting parameter LF.28. You will need to try all possible settings, LF.28 = 0,1,2,3. One of them should give you controlled operation of the motor and motor current below the FLA of the motor. However the direction of travel of the car in the hoist way may be reversed. If this is the case change LF.28 as described below and reverse the speed reference direction in the elevator controller.

Changes to LF.28 to reverse car direction

0 -> 2	1 -> 3
or	or
2 -> 0	3 -> 1

Changes to LF.28 to reverse encoder counting direction

0 -> 1	2 -> 3
or	or
1 -> 0	3 -> 2

5.12 High Speed Tuning

5.12.1 System Inertia Learn For optimum control of the elevator, it is recommended to learn the system inertia and activate the feed forward torque controller. Feed forward control reduces the dependence on the speed feedback from the motor by predicting what the system will do and providing the required torque command based on that prediction.

The first step in learning the system inertia is to get the car running at contract speed over multiple floors. If the auto tune process in section 5.5.3 or 5.6.3 has not been completed, complete the auto tune first. The counter weight balance shall be adjusted and finalized. Additionally if required, compensation chains or ropes shall be installed in their final state. Note, the best results are possible with compensation. The learn process is carried out by precisely balancing the car with weights inside the car. The procedure is outlined below.

- 1) Pick two floors and run the car only between these two floors. During the learn process the rate of acceleration will be lower so it might take 2 or more floors to reach contract speed.
- 2) Place balanced load in the car.
- 3) Display the actual motor torque in parameter ru.12.
- 4) Run the car up and down, note the value of ru.12 once the car is running at contract speed. When the car is balanced the value will be near zero and should be about the same in each direction, although the value may be opposite in sign, i.e. +15 up and - 15 down.
- 5) Add or subtract weight a small amount at a time, until the values in each direction are close. Excessive friction in the hoist way may result in higher torque values.
- 6) Once the car is balanced, adjust the speed (tach) following error in the controller to the maximum value as during the learn process the actual motor speed will not track the controller's command.
- 7) Set parameter LF.3 to I Lrn and press enter. The display will confirm with StArt. Note: if at any point it is necessary to abort the learn process, press the Func key on the drive's key pad. Additionally, it is not allowed to navigate away from this parameter during the learn process.
- 8) Register a call, the display will change and show the torque value. Monitor the car speed on the controller and make sure the car is getting up to speed. If not, increase the number of floors the car is traveling.

Initial Start Up

- 9) Run the car up and down a few times. Note that during the acceleration, the same value should be reached and then a much lower value during the constant speed portion of travel. Disregard the values during deceleration.
- 10) After having gotten a sense of the values, it will now be necessary to write down the values after each run. The values to note are the value during acceleration in the up direction and the value at constant speed in the up direction. It does not matter whether they are positive or negative. Write them all down as a positive value. Get values from about ten runs.
- 11) Add all acceleration values together and divide by 10. Add all constant speed values together and divide by 10. Then subtract the constant speed value from the acceleration value. The result is the value you need.
- 12) With the car standing still, press the Enter key on the keypad of the drive. The display will show VALuE. Press the up arrow key and scroll up to the value from step 11.
- 13) Once the value is correct, press Enter. This stores the acceleration torque value in parameter Ld.29. Additionally this calculates the system inertia and sets up the feed forward control in parameters Ld.30...Ld.32.
- 14) At this point the drive is back to normal run mode. The car should accelerate normally. In the controller, readjust the speed (tach) following error to a more normal value.
- 15) The process can be repeated starting from step 6.

5.12.2 Feed Forward Torque Control, FFTC

- 1) Now that the inertia is set, the FFTC is active. The effectiveness of the control can be simply influenced by the gain value in parameter Ld.32. 90% is the typical value which should give good results. However, if the value is lowered, the influence of the FFTC will be reduced, higher values will intensify the result. Values in the range 50% to 150% can be typical. Setting this value to 0% turns off the FFTC.
- 2) With the FFTC turned on it is possible to reduce the values of A.LF.31, d.LF.31, A.LF.32, d.LF.32, although, it is not always necessary.
- 3) Depending on the type of elevator, geared or gearless, more or less offset gain (LF.33) may be required.

5.12.3 Speed Gain Adjustment

When not using the FFTC or when the gain of the FFTC must be kept lower, the speed control gains play a greater role in controlling the elevator. Always start adjustment with the proportional gain LF.31 and then proceed on the the integral gains in LF.32 and LF.33. All the gains are divided into 3 values, A for acceleration and contact run, d for deceleration, and P for pre-torque. The pre-torque values are for the pre-torque function only and are described in section 5.12.4.

Proportional Gain

The proportional gain maintains general control and stability over the entire speed range. The proportional gain is split into two values one for acceleration and constant speed (A.LF.31) and one for deceleration (d.LF.31). Additionally, the value can be automatically reduced as the speed transitions from slow speed to contract speed.

LF.31 sets the overall gain. Lower values, less than 1000, may result in loose control and overshoot of the command speed as high speed is reached. Higher values can cause high frequency oscillation or a buzzing sound in the motor. If tighter control is necessary during the start or stop that gain can be raised accordingly in A.LF.31 or d.LF.31.



3000 is a good number to start with for geared and high speed gearless applications. For lower speed to medium speed gearless, 1500 is a good starting point.

LF.31 = 1000 Actual speed overshoots during transition into high speed. Raise in steps of 500 until overshoot is gone, 3000 is a good number.

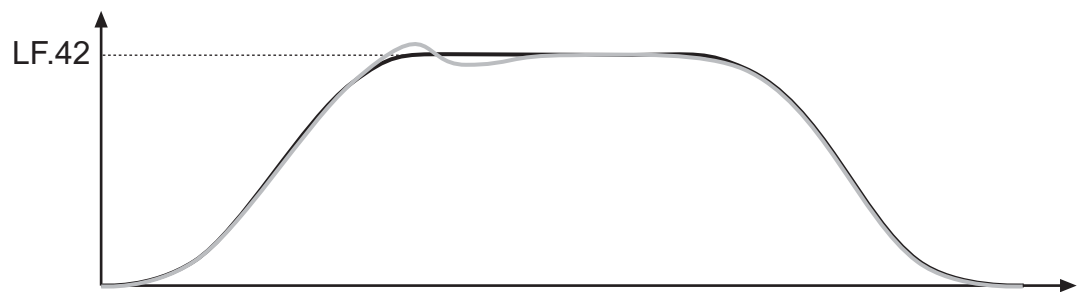

LF.31 = 500 Motor has poor control with strong oscillations. Raise in steps of 500 until better control is achieved.

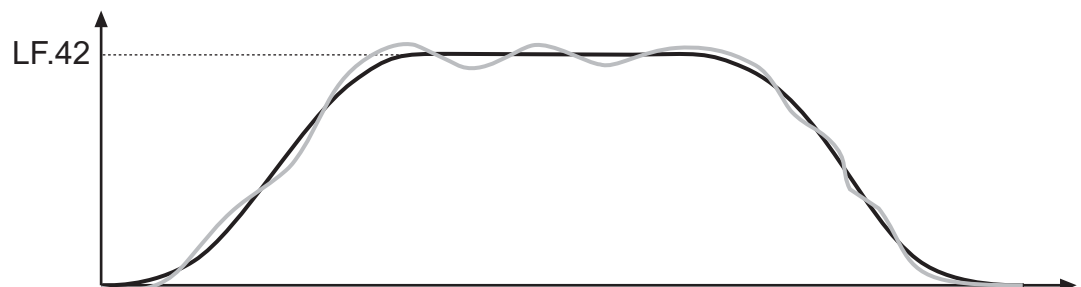

Initial Start Up

LF.31 = 5000

Loud audible noise or vibration from the motor, lower the value in steps of 500 until the noise/vibration stops.

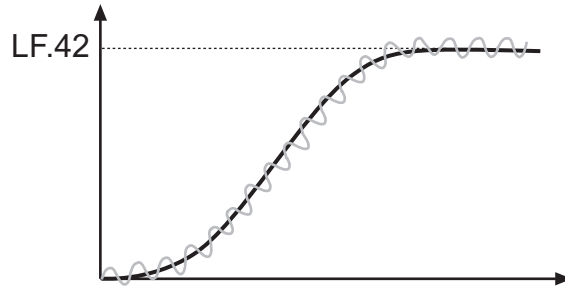

Integral Gain

The integral gain is responsible for correcting long term average error in speed as well as providing increased control and rigidity at lower speeds for starting and stopping. The integral gain is split into two values one for acceleration and constant speed (A.LF.32) and one for deceleration (d.LF.32).

LF.32 provides an overall gain value for all speeds of operation. If this value becomes too high, greater than 600, it can result in torque pulsations during acceleration and deceleration. If the value becomes too low, less than 250, the tracking of the command speed will suffer and the system may not reach contract speed.

LF.32 = 100

Speed lags the command, sometimes does not reach contract speed, under shoots the floor. Raise in steps of 100 until better control is achieved.

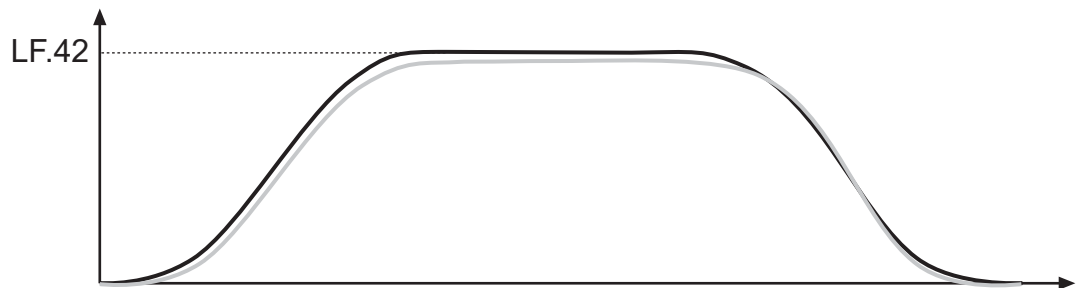

LF.32 = 1500

Acceleration is jerky, bunching or spotting occurs during deceleration. Lower LF.32 in steps of 200. A good range is 200-600.

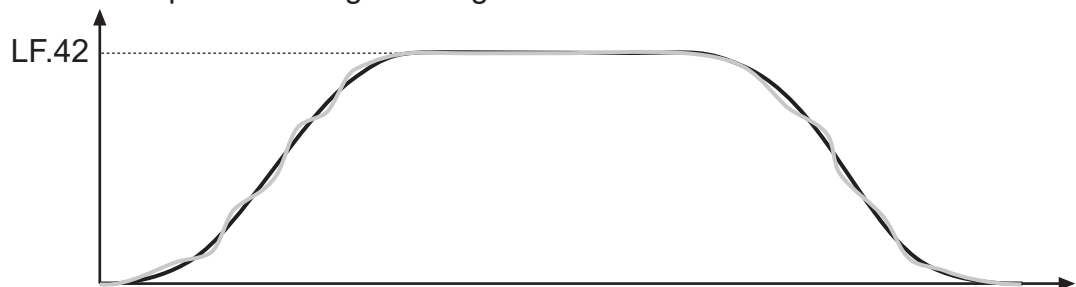

LF.33 provides an offset to the gain value at low speeds. Again this parameter provides two adjustments; one for acceleration and one for deceleration. During starting and stopping it is necessary to have higher gain values to overcome friction as well as maintain good control. The total integral gain value is the sum of LF.32 and LF.33 at low speeds.

US.20 and US.21 define the corner speeds where the gain begins to ramp up and where the gain reaches the maximum value. For gearless application it may be necessary to increase US.21 to around 100 ft/min and decrease US.20 to 3 ft/min

Common problems during starting and their solutions

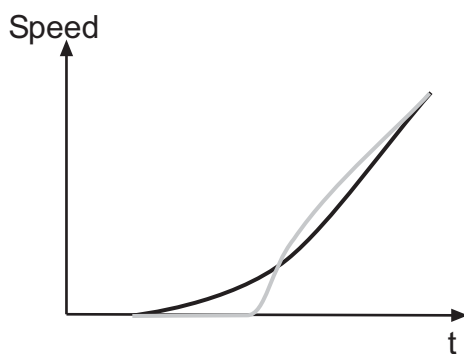

LF.33 = 1000

Speed lags the command on take off. This is typical with worm gear machines when trying to break free. The start feels very hard or abrupt. Raise in steps of 500.

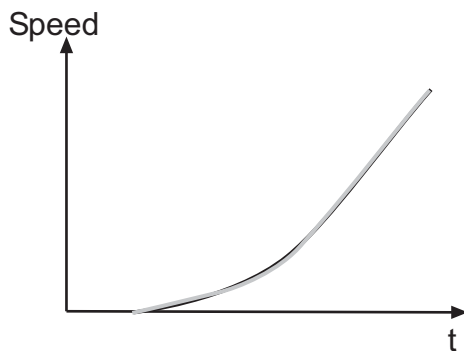

LF.33 = 3000

Higher KI Offset value aids the torque build during starting. Helps to overcome break away torque of machine. Actual speed tracks the command.

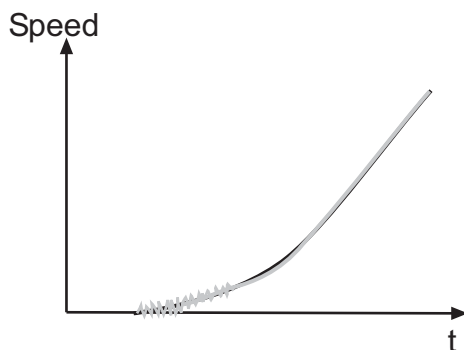

LF.33 = 6000

High KI Offset value causing vibration or audible noise in the motor at take off. Lower in steps of 500.

Initial Start Up

Common problems during stopping and their solutions

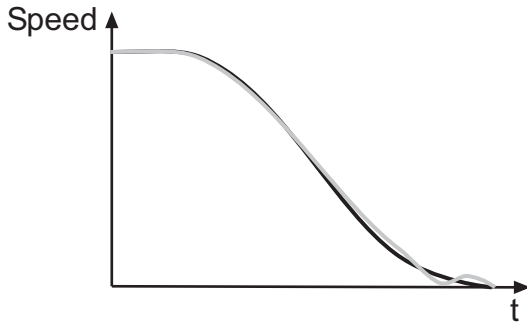

LF.33 = 500

Speed lags during the final phase of decel, one slow oscillation just before stop, under shooting of floor. Raise in steps of 500.

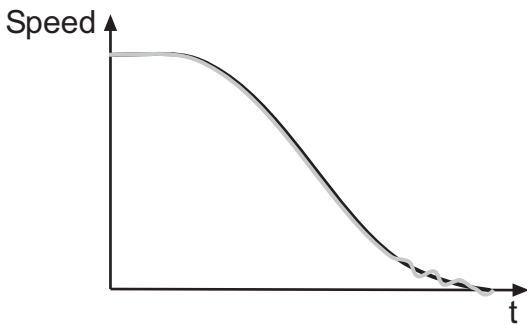

LF.33 = 3000

Higher offset value leads to bunching or steps during final approach, faster oscillations, reduce value in steps of 500.

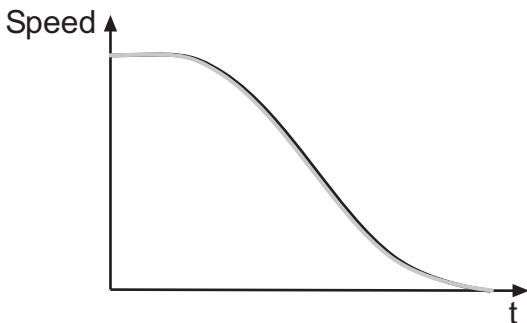

LF.33 = 1000

Offset value OK.

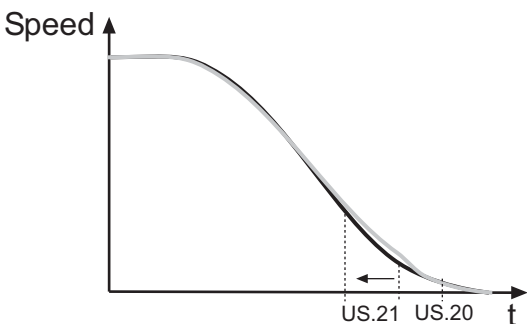

LF.33 = 1000

OK but corner speed US.21 too low. In this case the speed begins to lag during the deceleration but then recovers in the final approach. With gearless it is often necessary to raise the corner speed of the start of the offset to a higher value.

Raise US.21 from 24ft/min to 100ft/min.

5.12.4 Synthetic Pre-Torque

Synthetic pre-torque is a feature of the drive which can be used to minimize, if not totally eliminate, the roll back which normally occurs when the brake is lifted.

The function is turned on in parameter LF.30 and adjusted in parameters US.17 & US.18 and P.LF.31 & P.LF.32. The following procedure will assist in the adjustment of the pre-torque.



Adjust brake spring tension, brake voltage, and brake timing first. Note, that it is often advantageous to use lower spring tension and lower brake pick voltage to provide a softer lifting of the brake. This allows for a smoother transition from brake to motor. It should be noted that any subsequent changes to the brake could require readjustment of the synthetic pre-torque.

- 1) Set the speed to zero in order to clearly see the rollback.
- 2) Run the car on inspection and note the roll back.
- 3) Turn on the synthetic pre-torque by setting LF.30 = 5. Also adjust US.17 = 0.2 sec. and US.18 = 0.2 sec.
- 4) Run the car on inspection. If there is any vibration or audible noise at the start, lower the value of P.LF.32 by 2500 and try again.
- 5) Increase the value of US.17 by 0.05 sec. If the rollback is reduced proceed to step 6, otherwise continue raising the value of US.17 again by 0.05 sec until a difference in the rollback is perceived.
- 6) Note the value of US.17 and raise it again by 0.05 seconds. If the roll back gets better try raising it again. Keep raising US.17 until it gets worse again. Then back off the value by 0.05 sec. Note there may still be some rollback at this point.
- 7) Increase the value of P.LF.32 in steps of 2000 and run the car. Roll back should be further reduced. Values as high as 20000 are normal. If there is vibration or audible noise at start reduce P.LF.32. In some cases it may help to raise the value of P.LF.31 to minimize vibration during the pre-torque phase. Adjust in steps of 1000. Finally reduce US.18 by 0.05 seconds.
- 8) Return the pattern gain or inspection speed to the previous values.
- 9) Run the car on automatic.

Initial Start Up

The goal is to adjust timer US.17 such that the pre-torque ramp down phase occurs exactly when the brake releases and the roll back occurs. Note: by monitoring LF.86 it is possible to see what phase the drive is in. A value of 4 is the ramp up phase and is controlled by US.17. A value of 3 is the ramp down phase US.18.

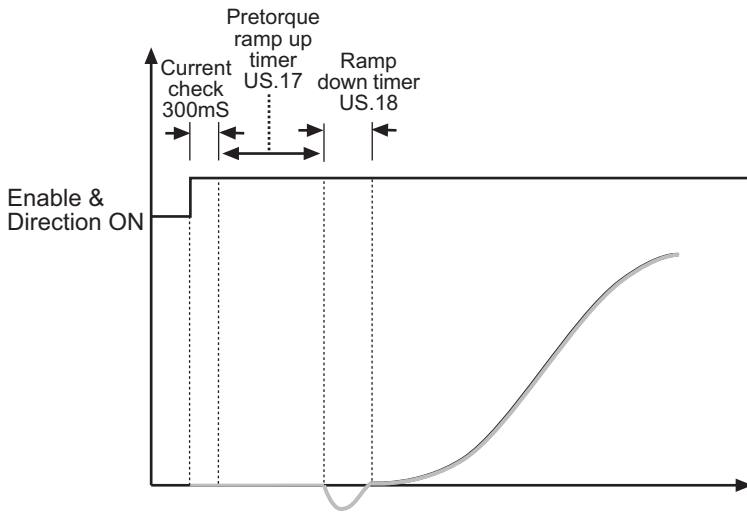

When adjusted properly, the brake should pick, the motor holds the load for a short period about 1/4 second, and then the acceleration begins.

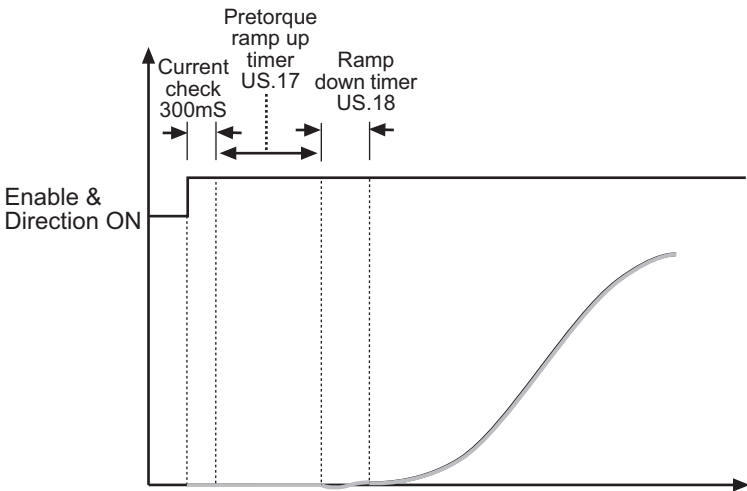

6. Parameter Description

6.1 US-Parameters

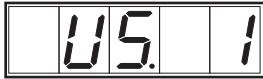

Password

With different passwords different parameter groups can be accessed for advanced programming.

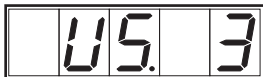

Load defaults

By selecting LoAd and pressing ENTER, all the LF parameters are returned to the factory default values. Note the display will automatically change to show the value of LF.99 upon successful loading of the default values.

Adjustment value: LoAd = reset all LF parameters

Displayed responses: PASS = default successful
bdPAS = default not successful



Load configuration

By selecting LoAd and pressing ENTER, the selected configuration file in US.10 and all the existing LF parameter values will be loaded into the drive. *Note: if the configuration is changed in US.10, the LF parameter values are returned to the factory default values. In this case, this should be done before any programming of the drive is carried out as all parameters will be cleared.* The display will change automatically to LF.99 upon successful loading of the configuration. The process may take several seconds.

Adjustment value: LoAd = Load Configuration

Displayed responses: Pro9 = Loading configuration
PASS = Load successful
bdPAS = Load not successful

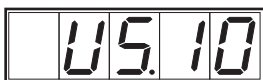

Select configuration

This parameter allows the user to select which mode the drive will operate in. The possibilities are closed loop induction motor, closed loop permanent magnet motor, and low speed gearless modes. Select from the list below and then load the configuration file into the drive through parameter US.4.

Adjustment value: ICL5d = Closed loop induction
I9L5S = Closed loop induction gearless
PCL5d = Closed loop permanent magnet
P9L5S = Closed loop permanent magnet gearless

Parameter Description - Basic Set Up

Other US parameters

These US parameters are special parameters which are not needed in every application. They are turned off by default by the control manufacturer. The following serves only as a list of these parameters. For further adjustment refer to section 8.0.

US.14	Comm Error Para Address
US.15	Comm Error Data
US.16	E.OL2 function
US.17	Pretorque Timer-Ramp Up
US.18	Pretorque Timer-Ramp Dwn
US.20	Max speed for max Ki
US.21	Speed for min Ki
US.22	Speed dependent Kp Gain
US.23	Min KPgain at high speed
US.24	KD speed gain
US.25	Phase current check
US.26	Encoder diagnostic
US.27	Power Unit Code
US.28	Analog input zero volt clamp
US.29	HSP5 Watchdog Time
US.33	E.dOH Function
US.34	Analog Pattern Gain
US.35	Reference Splitting
US.36	Baud Rate X6C (DIN66019)
US.37	Test Function
US.83	Encoder 2 Output PPR
US.84	Analog Output 2

6.2 LF-Elevator Parameters



Signal / operating mode

This value determines the type of speed selection and rotation setting.

Value range:

- AbSPd = Absolute Analog Speed
- d SPd = Digital Speed Selection
- A tor = Analog Torque Control
- A SPd = Analog Speed Control
- SErSP = Serial Com. Speed Control
- bnSPd = Binary Speed Selection

Default setting: bnSPd

Value	Control mode	Direction Selection
AbSPd	Abs. Analog Spd. Control 0...+10V terminals X2A.1, X2A2	terminals X2A.14 & X2A.15
d SPd	Digital Speed Control terminals X2A.10, X2A.11, X2A.12,X2A.13	terminals X2A.14, X2A.15
A tor	Analog Torque Control -10V...0... +10V terminals X2A.1, X2A2, X2A.3, X2A4	terminal X2A.14, does not determine direction used only for triggering the start sequence
A SPd	Analog Speed Control -10V...0...+10V terminals X2A.1, X2A2	terminals X2A.14 & X2A.15 do not determine direction. Used only for triggering the start sequence
SErSP	Digital Serial Speed Control Serial communication 16 bit signed speed value	Serial communication 16 bit control word
bnSPd	Binary Speed Control terminals X2A.11, X2A.12, X2A.13	terminals X2A.14, X2A.15

When LF.2 = A tor then: max. system speed is approximately 110% of (LF.20)

When LF.2 = AbSPd or A SPd then: 0 ... ±10V = 0 ... ± max. system speed (LF.20)

Parameter Description - Basic Set Up

a) Analog set speed selection LF.02 = Ab5Pd



A unipolar analog signal is connected to the terminals X2A.1(+) and X2A.2 (-). Terminals X2A.3 and X2A.4 can be used for pre-torque input. Additionally with this setting the analog output (X2A.5) for motor speed becomes unipolar as well.

0 ... 10V = 0 ... max. system speed (LF.20)

Terminals X2A.14 and X2A.15 are used to select direction and activate the start and stop routine. The directions below must be followed in the exact sequence they are listed:

- Start:
- 1.) Enable on X2A.16=on
 - 2.) "Direction" input terminal (X2A.14 = on or X2A.15 = on)
 - 3.) Drive commences current check and magnetizes the motor when ready it will activate the DRO output X2A.27...29.
 - 4.) Give analog speed signal
- Stop:
- 1.) Analog signal => 0V
 - 2.) Terminal X2A.14 / X2A.15 = off
 - 3.) Enable X2A.16=off after the sum of the times adjusted in LF.78 and LF.79.

b) Input coded set speed selection LF.02 = d 5Pd

Digital speed setting uses preset digital values in the drive as command speeds. The drive creates the driving profile between selected speeds.

	X2A.10	X2A.11	X2A.12	X2A.13			
Speed =0	0	0	0	0			
S _{Leveling}	1	0	x	x			
S _{High Leveling}	0	1	x	x			
S _{Intermediate}	1	1	x	x			
S _{High}	0	0	1	x			
S _{Inspection}	0	0	0	1			

Symbol: 1 = Input is active
 0 = Input is not active
 X = Setting has no effect or don't care

c) Analog Torque control LF.02 = R tor

The differential analog signals are connected to the terminals X2A1(+) and X2A2(-) and X2A3(+) and X2A4(-). The actual torque command is the sum of the differential inputs.

Torque command = $(X2A1 - X2A2) + (X2A3 - X2A4)$.



In a torque controlled system the maximum speed is controlled by the elevator control not the drive. However for safety reasons the drive will internally limit the speed to 110% of LF.20 or contract speed.

Terminal X2A.14.5 is used to activate the starting and stopping routine. The directions below must be followed in the exact sequence they are listed:

- Start:**
- 1.) Enable X2A.16=on
 - 2.) Select direction input X2A.14
 - 3.) Drive commences current check and magnetizes the motor when ready it will activate the DRO output X2A.27...29.
 - 4.) Controller gives analog torque signal

- Stop:**
- 1.) Analog signal => 0V
 - 2.) Direction X2A.14 = off
 - 3.) Enable X2A.16=off after the sum of the times adjusted in LF.78 and LF.79.

d) Analog set speed selection LF.02 = R SPd

A Differential analog signal is connected to the terminals X2A.1(+) and X2A.2 (-). Terminals X2A.3 and X2A.4 can be used for pre-torque input.



0 ... ±10V = 0 ... ±max. system speed (LF.20)

Terminals X2A.14 and X2A.15 are used to activate the start and stop routine. The directions below must be followed in the exact sequence they are listed:

- Start:**
- 1.) Enable on X2A.16=on
 - 2.) "Direction" input terminal (X2A.14 = on or X2A.15 = on)
 - 3.) Drive commences current check and magnetizes the motor when ready it will activate the DRO output X2A.27...29.
 - 4.) Give analog speed signal

- Stop:**
- 1.) Analog signal => 0V
 - 2.) Terminal X2A.14 / X2A.15 = off
 - 3.) Enable X2A.16=off after the sum of the times adjusted in LF.78 and LF.79.

Parameter Description - Basic Set Up

e) Digital serial communication LF.02 = 5Er5P

Serial communication is used to operate the drive in speed control mode. The cyclic serial update rate at 56kbps is about 11mSec. The default serial parameter channel assignments are listed below. Other assignments are possible and are freely assigned via the serial communication. Consult the manufacture for more information on implementing this control scheme.

Digital commands to the drive

The command speed is a 16 bit signed value representing the motor speed.

The control word is a 16 bit value which is used to digitally activate the inputs (enable, direction, reset, etc).

The pre-torque is an 11 bit signed value which is used to provide roll back compensation.

Digital commands from the drive

The actual speed is a 16 bit signed value representing the actual motor speed as measured by the encoder.

The status word provides the status of the drive in addition to the output conditions.

The actual torque provides the torque value back to the controller.



In this mode the drive automatically puts LF.3 = Stop when changing parameters. The car must be stopped for this to happen.



Once in run mode, the drive must see a serial communication request at the X6C serial port at minimum every 50mSec. If not the drive will trigger an E.BUS fault.

Clearing an E.BUS error while in serial com mode. When in this mode, if the controller stops communication with the drive, it may not be possible to clear the E.BUS fault and view other parameters. Therefore the following can be used to override the error such that trouble shooting can occur.

While the display shows E.BUS press and hold both the ENT and the START key. The display will show the previously displayed parameter and allow navigation of the parameters. The internal fault will not reset until the serial communication has been reestablished.

f) Binary coded set speed selection LF.02 = bn5Pd

Binary speed setting uses preset digital values in the drive as command speeds. The drive creates the driving profile between selected speeds. The inputs are binary coded to allow up to seven speeds. Additionally in this mode, more advanced and multiple profiles can be established. See parameters LF.41...LF.56. One speed can be pre-defined as an emergency run speed in which the drive operates automatically under emergency operation conditions. See parameter LF.61 for more details.

	X2A.10	X2A.11	X2A.12	X2A.13	Para.		
Speed =0	x	0	0	0			
S _{Leveling}	x	1	0	0	LF.41		
S _{High Leveling}	x	0	1	0	LF.44		
S _{Inspection}	x	1	1	0	LF.43		
S _{High}	x	0	0	1	LF.42		
S _{Intermediate_1}	x	1	0	1	LF.45		
S _{Intermediate_2}	x	0	1	1	LF.46		
S _{Intermediate_3}	x	1	1	1	LF.47		

Symbol: 1 = Input is active
 0 = Input is not active
 X = Setting has no effect or don't care

Parameter Description - Basic Set Up



Drive configuration

This parameter is used to put the drive into different modes. The modes are defined below.

- Value range:
- run Run mode. All normal functions.
 - conF Configuration mode. Used in special cases to trouble shoot operation
 - Stop Drive stopped. Motor can not run, drive will not respond. When using serial com, this mode allows parameter changes.
 - S Lrn System Learn. Auto tunes the drive to the motor. Refer to section 5.5.3 and 5.6.3 for instructions.
 - I Lrn Inertia Learn. Learns the system inertia and activates the FFTC. Refer to section 5.12.1.
 - P Lrn Pole Learn. Learns the pole positions of PM motors. Refer to section 5.11.2 and 5.11.3 for instructions.

 - SPI Static Pole Learn. Learns the absolute encoder position for a PM machine under the brake without sheave movement. Refer to section 5.11.1 for instructions.

Default setting: Stop



This parameter is time limited for safety. Once conF is activated you have 90 seconds to complete the task at hand. After the timer runs out, the mode will change to Stop. It will be necessary to change back to conF thus resetting the timer to continue. Once all set up is complete set this parameter to run.



Selected motor

This parameter displays the current mode of operation, open or closed loop, geared or gearless, induction motor, synchronous motor. The parameter is read only.

Possible displays:

ICLSd = Closed loop induction

I9L55 = Closed loop induction gearless

PCLSd = Closed loop permanent magnet

P9L55 = Closed loop permanent magnet gearless



Drive fault auto reset

With LF. 5 all drive faults can be automatically reset.

The number adjusted in this parameter determines how many times per hour the elevator drive will automatically reset faults. Before resetting the fault, the drive will wait 4 seconds to allow everything to stop or stabilize. It is not fault specific, so with the default setting of 5, if the drive experiences 6 different faults in one hour the unit will latch the last fault and not reset. See parameter LF.98 for fault history information.

Unit: 1
Value range: 0...10
Default setting: 5

Note: a setting of "0" means no fault resets.

Parameter Description - Basic Set Up



Electronic motor overload protection

This parameter is used to activate and select the type of motor overload function. Depending on the setting of this parameter, the Elevator Drive will trigger a drive fault E.OH2 causing the motor to stop. The trigger level is established in parameters LF.9 or LF.12

Value range: off...on
Default setting: off
Adjustment value: as required



This function must be activated to ensure the motor protection function is operational!

The trip curve is in accordance with VDE 0660 Part 104, UL508C section 42, and NFPA 70 Article 430 part C. It is defined as follows:

- 100% of trip current => continuous running
- 120% of trip current => trip after 2 hours
- 150% of trip current => trip after 2 minutes
- 200% of trip current => trip after 1 minute
- 800% of trip current => trip after 5 seconds

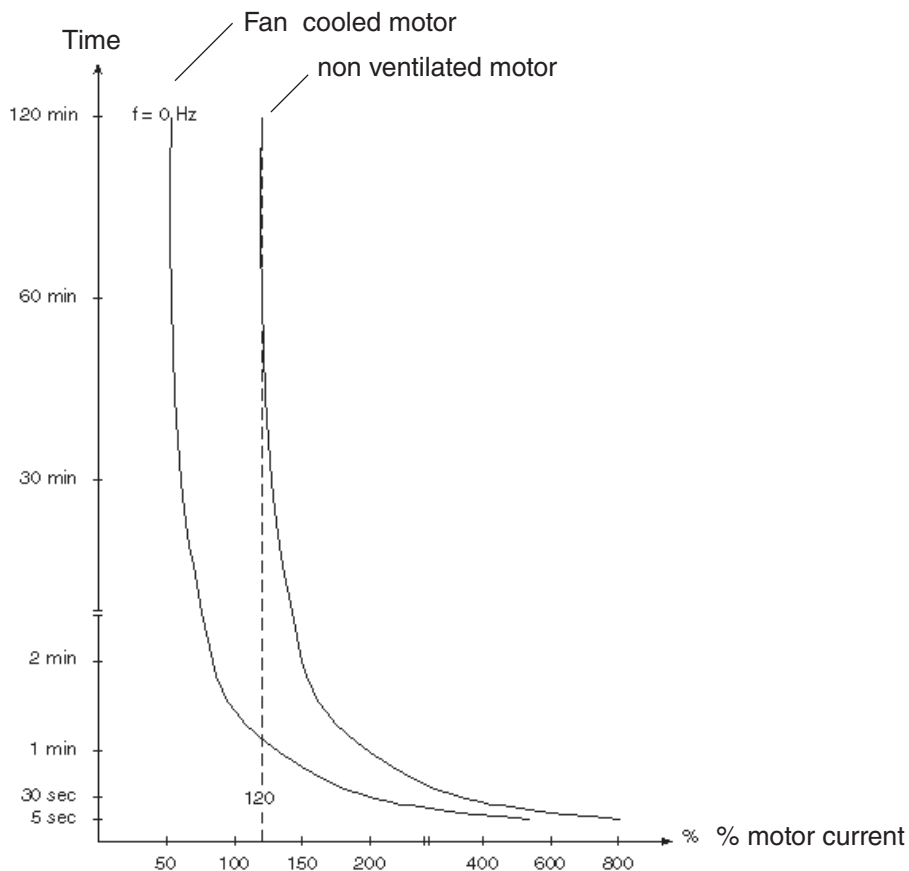



The following parameters configure the COMBIVERT Elevator Drive to the particular motor. Correct adjustment of these parameters is critical for proper operation of the system. Depending on the mode of operation the units and or range of acceptable values may change. Parameters LF.10 through LF.19 have dual functions depending on the type of motor.

For induction motor configuration modes the parameter information will be indicated with the symbol



For synchronous permanent magnet motors, configuration mode the parameter info will be indicated with the symbol



Electronic motor overload current



This parameter sets the current threshold in amps above which the Elevator drive activates the motor overload function.

Unit: ampere
 Value range: 1.0...1.1 x drive rated current
 Default setting: 8.0A
 Adjustment value: in accordance with motor nameplate



For PM motors the current threshold for electronic motor protection is set equal to the rated motor current in LF.12. Some motors must be protected from long term peak current to prevent damage to the motor windings. This parameter is then used to limit the peak current to the motor. If the motor current exceeds this value for longer than 3.0 seconds, the drive will automatically trigger the error E.OH2 and shut down operation.

When adjusting the rated motor current in LF.12, this value is automatically set to 3 times the value of LF.12. After setting LF.12, this parameter can then be adjusted based on the max. current allowed by the motor manufacturer.

Unit: ampere
 Value range: 1.0... drive peak current
 Default setting: 3 times LF.12
 Adjustment value: in accordance with the motor



If this parameter is set too low, it may interfere with operation of the elevator, resulting in shut downs.

Parameter Description - Motor Data



Rated motor power



Enter the rated power of the motor.

Unit: hp
 Value range: 0.0...125 hp
 Default setting: 5.0 hp
 Adjustment value: in accordance with the motor name plate



The power value is calculated from the torque and speed. Therefore this parameter becomes read only.



Rated motor speed



Unit: rpm
 Value range : 10.0....6000.0 or 500.0
 (based on config mode)
 Default setting: 1165.0 or 150.0
 (based on config mode)

Adjustment value: in accordance with the motor name plate



You may not enter the motor-synchronous speed (e.g. 1800 rpm for a 4 pole motor, 1200 rpm for a 6 pole motor, and 900 rpm for a 8 pole motor). Ask the manufacturer for the motor rated speed if you cannot find it on the name plate or use the following example to estimate the rated speed.

Example: If the name plate reads 1200 rpm (synchronous speed) then the value that should be entered must be lower. For starting purposes, one can estimate the slip at about 2.9%. Then through running the elevator it is possible to determine whether further adjustments are necessary. 2.9% of 1200 is 35 rpm. So for starting, use the value $1200 - 35 = 1165$ rpm which is the default value.

LF.11 Valid Adjustment Range for 60Hz motors

From this parameter along with the rated frequency in LF.13, the COMBIVERT Elevator Drive calculates the number of motor poles. As a result there are limits as to how low the value can be adjusted for a motor with a certain number of poles. Refer to the table to the right for the valid adjustment range of 60Hz motors.

4 poles	1201...1799 rpm
6 poles	901...1199 rpm
8 poles	721...899 rpm
10 poles	601...719 rpm



Rated motor speed



Unit: rpm
 Value range : 10.0....6000.0 or 500.0
 (based on configuration mode)
 Default setting: 1165.0 or 150.0
 (based on configuration mode)

Adjustment value: in accordance with the motor name plate

For permanent magnet synchronous motors there is no slip. Therefore the value entered must be exactly the synchronous rotational speed based on the rated frequency as noted below. With this there is no further adjustment necessary. Do not round this value off to the nearest whole number. With this there is no further adjustment necessary.

$$LF.11 = \frac{LF.13 \times 120}{\text{motor poles}}$$

OR

$$LF.13 = \frac{LF.11 \times \text{motor poles}}{120}$$



Rated motor current



Enter the motor nameplate rated current (FLA).



Unit: ampere
 Value range: 1.0...1.1 x Inverter rated current
 Default setting: 8.0 A
 Adjustment value: in accordance with the motor name plate



Rated motor frequency



Enter the exact rated frequency of the motor.



Unit: hertz
 Value range: 4.0...100.0 Hz
 Default setting : 60.0 Hz
 Adjustment value: in accordance with the motor name plate

$$LF.11 = \frac{LF.13 \times 120}{\text{motor poles}}$$

OR

$$LF.13 = \frac{LF.11 \times \text{motor poles}}{120}$$

Parameter Description - Motor Data



Rated motor voltage



Enter the name plate rated voltage.

Unit: volt
Value range: 120...500 V
Default setting: 230 or 460 V based on drive voltage
Adjustment value: in accordance with the motor name plate



Enter the no load phase to phase back EMF rms voltage at rated speed (LF.11).

Unit: Vrms / at rated speed
Value range: 1..32000 V
Default setting : none
Adjustment value: in accordance with the motor name plate



Note: For LF.80 software versions =< v1.3 this parameter displayed volts peak at 1000 rpm. So the value was significantly higher (i.e. greater than 1000V). When upgrading to the newer software this value must be recalculated using the new method (Vrms at rated speed)

To convert the old value from V1.3 to the new value for V1.7 use the following equation:

$$V1.7 \text{ value for LF.14} = \frac{V1.3 \text{ value} \times LF.11}{1000 \times 1.414}$$

This value is measured during auto tuning and will provide the best value.



Power factor



This parameter is not the efficiency of the motor but the ratio of the magnetizing current to the total phase current of the motor. Lower power factor values will increase the magnetizing current to the motor and thus increase the field strength resulting in tighter control of the motor. Higher values decrease the magnetizing current and the field strength.

Unit: 1
Value range: 0.50...1.00
Default setting: 0.90
Adjustment value: in accordance with the motor name plate

Note: If not known, a value of 0.9 is recommended for old high slip motors and a value of 0.65 is recommended for gearless induction motors.



For PM motors this parameter is not required and therefore is not visible.

LF.16

Field weakening speed



The field weakening speed determines at which speed the peak torque limit starts being reduced. It is necessary to reduce the peak torque limit of the motor since the drive's ability to force current into the motor is limited by the applied voltage as rated speed is reached.

If the drive tries to demand more torque than the motor can produce given the available voltage and actual motor speed, it is possible that the breakdown torque of the motor will be exceeded and as a result the motor will appear to stall and run at less than desired speed.

Generally this phenomenon can be identified as the car reaches contract speed momentarily but then drops to a lower speed or the car speed stalls at some speed lower than contract speed. Monitor parameter ru.42. If the value is reaching 100% or higher, the voltage limit is being reached. As a result the peak torque command must be further limited in order to maintain control of the motor.

The solution is simply to reduce the value of LF.16 to about 60% of synchronous speed (720 rpm for a 1200 rpm motor). A setting of 45% of synchronous speed should be used as the practical lower limit of this parameter.

Unit: rpm
 Value range: 0.0...6000 rpm
 Default setting: 960.0 rpm
 Initial adjustment value: approx. 80% of synchronous speed

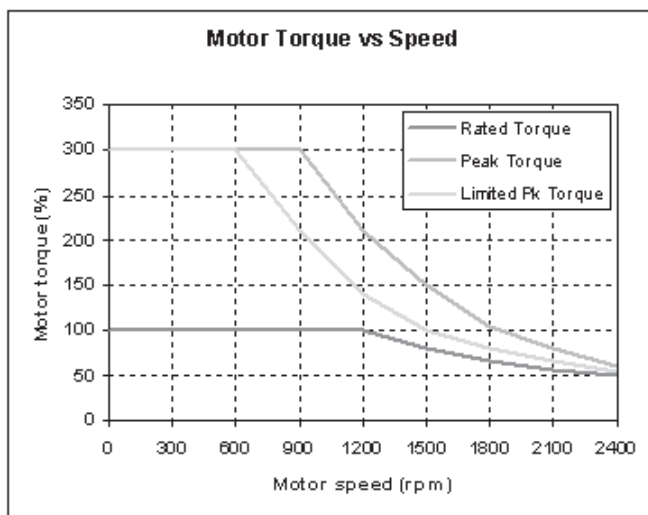

For PM motors this parameter is not necessary and therefore is not visible.

Parameter Description - Motor Data



Rated motor torque



For IM the torque value is calculated from the rated speed (LF.11) and rated power (LF.10). Therefore this value is read only.

Unit: lb ft
Value range: 1..10000 lb ft
Default setting: Calculated



For PM motors the torque value must be entered and is used to establish the torque constant. Enter the rated name plate torque.

Unit: lb ft
Value range: 1..10000 lb ft
Default setting: 18 lb ft
Adjustment value: enter the motor name plate value

Some motors have the torque stated in Nm. To convert Nm to lb ft: multiply Nm by 0.738.

If the torque is not listed on the name plate you may use the the following equations to calculate the torque:

$$\text{Torque [lb ft]} = \frac{\text{Name plate HP} \times 5258}{\text{Nameplate Speed (rpm)}}$$

OR

$$\text{Torque [lb ft]} = \frac{\text{Name plate kW} \times 7043}{\text{Nameplate Speed (rpm)}}$$

OR

$$\text{Torque [lb ft]} = \frac{\text{Name plate Nm}}{1.355}$$



For PM machines changing LF.17 automatically sets the maximum torque in 0.LF.36 to prevent high current to the motor during construction.

For high speed operation, 0.LF.36 will typically need to be raised to 200-250% of LF.17.

LF.18

PM motor resistance



This parameter not required for closed loop induction motor operation and will not be visible in these modes.



For PM motors enter the phase to phase resistance value. Some motor manufacturers list the per phase value therefore you must multiply by two. This value can also be measured by the drive's auto-tune function, see parameter LF.3. Incorrect settings of this parameter could lead to oscillation in the current control and audible noise in the motor, since the regulator values for the current control are calculated from this value.

Unit: ohms
Value range: 0.000...49.999
Default setting: 1.000
Adjustment value: enter the motor resistance value

LF.19

PM motor inductance



This information is not used for induction motors and therefore the parameter is not visible in induction motor mode.



This is the total phase to phase reflected leakage inductance of the motor winding. The inductance listed on the manufacturer's data sheet will most likely be for one phase. So it will be necessary to multiply the value by two and then enter it into the drive. This value can also be measured by the drive's auto-tune function, see parameter LF.3. Incorrect settings of this parameter could lead to oscillation in the current control since the regulator values for the current control are calculated from this value.

Unit: mH
Value range: 0.01...500.00
Default setting: 1.00
Adjustment value: enter the value from the manufacturer's data sheet.

Parameter Description - Machine Data



The following parameters relate to the machine data of the elevator. It is important to enter the correct values, such that both the motor and the car run at the correct speed.

LF.20

Contract speed

This is the elevator contract speed.

The speeds adjusted in parameters LF.42...LF.47 are limited by LF.20. Other internal values are calculated from LF.20.

With an analog speed signal the following is valid:

$$0 \dots \pm 10V = 0 \dots \pm \text{contract speed (LF.20)}$$

Unit: feet per minute

Value range: 0...1600ft/min

Default setting: 0 ft/min

Adjustment value: maximum speed of the system



If the motor does not run at the correct speed do not adjust this parameter! See parameter LF.22.

LF.21

Traction sheave diameter

Unit: Inches

Value range: 7.00...80.00 in

Default setting: 24.00 in

Adjustment value: measure the sheave diameter

LF.22

Gear reduction ratio

Enter the actual gear ratio. If the ratio is not known, see parameter LF.25 and enter the value from LF. 25 into LF.22

Unit: 1

Value range: 1.00 ... 250.00

Default setting: Geared = 30.00

Gearless = 1.00

Adjustment value: in accordance with the gear name plate



The ratio can be determined by counting the revolutions of the motor during one rev of the traction sheave.

Once the car is running on high speed, if the measured speed is slightly above or below the contract speed, the gear ratio can be changed slightly to compensate. Higher values in LF.22 will increase the car speed, lower values will decrease the car speed. Make very small changes at first!

LF.23

Roping ratio

Unit: 1
 Value range: 1...8 (1:1...8:1)
 Default setting: 1
 Adjustment value: in accordance with the system data

LF.24

Load weight

Unit: pounds
 Value range: 0...30000lbs
 Default setting: 0 lb
 Adjustment value: in accordance with the system

LF.25

Estimated gear reduction

This parameter is read only and will change when adjustments are made to LF.11, LF.20, LF.21 or LF.23.

This parameter can be used to estimate the gear ratio if it is not known. After correctly entering values into LF.11, LF.20, LF.21, and LF.23, read this value and then enter this value into LF.22. Then to verify, run the car at inspection speed, measure the actual speed with a hand tach. If the car speed is slower than the adjusted inspection speed (LF.43), then increase LF.22. If it is higher than the adjusted inspection speed, decrease LF.22.

Note: If LF.20 = 0.00 ft/min the value of LF.25 will be the same as the last calculated value.

Unit: .01
 Value range: 1.00...99.99

Parameter Description - Encoder Set Up



Encoder interface

This parameter is used to manage the encoder interface and its surrounding functionality. Depending on the type of encoder and encoder interface only some of these functions are supported. The parameter has been expanded using an offset number to denote the function.

The function of each offset is denoted below



Displays the type of encoder interface on the drive. Is also used to manually reset E.ENCC errors.



Displays the type of encoder connected to the drive, if the info is available from the encoder.



Displays the status of the encoder interface (encoder faults, etc.)

The key strokes below can be used to navigate to the desired offset number.

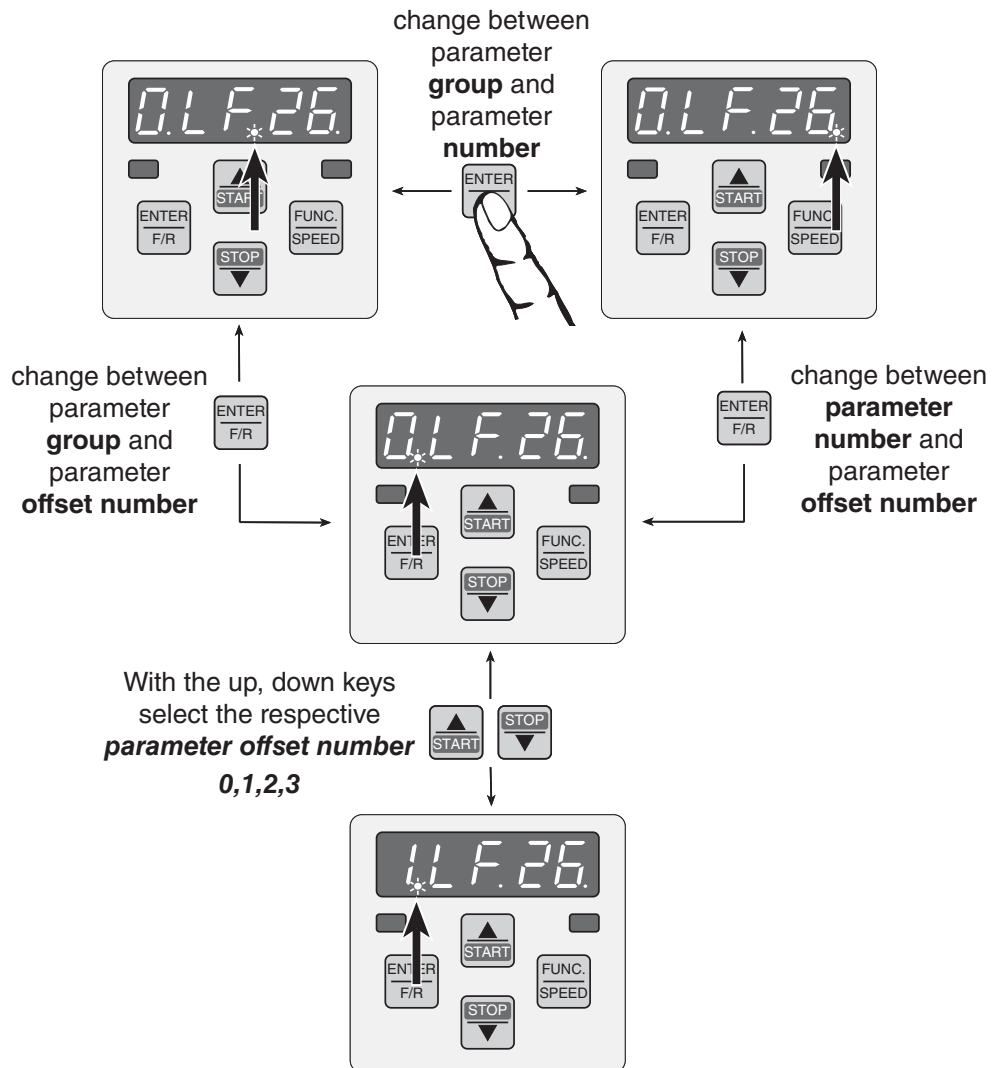



This parameter displays the type of encoder feedback installed in the drive. It is also used to reset E.ENCC error. Under normal operation this parameter displays the type of encoder feedback card installed in the drive. See the list below.

Additionally, if an E.ENCC error has occurred, and the problem has been corrected, the error can be reset by displaying the value of 0.LF.26 and pressing ENTER. This is the only way to manually reset the E.ENCC error. See 2.LF.26 below for more information on E.ENCC errors.

Display	Channel 1 (X3A)	Channel 2 (X3B)
noInt	No feedback card installed	
SSI	5V TTL incremental Synchronous Serial Interface,	absolute multi turn position encoder
rESoL	Resolver	5V TTL incremental output
HIPEr	Hiperface	5V TTL incremental output
Inc24	15-24V HTL incremental	5V TTL incremental output
IncIE	5V TTL incremental	5V TTL incremental output
SinCo	Sine Cosine / -SSI	5V TTL incremental output
I24PE	15-24V HTL incremental	5V TTL incremental output
EnDat	EnDat	5V TTL incremental output
PhASE	UVW	5V TTL incremental output



This parameter displays the type of encoder connected to the drive. It is only supported by HIPERFACE, EnDat or SIN/COS-SSI encoders.

Operator	Encoder
Display	Type
noEnc	No Encoder Detected
SCS67	SCS 60/70
SCn67	SCM 60/70
SinCo	SIN/COS no abs.
SinCo	SIN/COS abs.
SSI	SSI abs.
Sr556	SRS 50/60
Srn56	SRM 50/60
EnDat	EnDat
EnDat	EnDat Single Turn
EnDat	EnDat Multi. Turn
EncUn	Encoder Undefined

Parameter Description - Encoder Set Up

A digital display showing the text '2LF.26' in a segmented font, enclosed in a rectangular border.

This parameter displays the status of the connected encoder along with error messages and in case of a malfunction. It is only supported by HIPERFACE, EnDat or SIN/COS-SSI encoders.

Refer to the table on the following page for possible displays and their meanings.



When the status of the encoder interface changes to a value other than “communication established” conn, and the drive is enabled, the drive will trigger and E.ENCC fault. Press enter and the drive will change the display to this parameter and show the fault code. Once the problem has been corrected, the E.ENCC fault can be cleared by displaying the value of parameter 0.LF.26 and pressing enter.

A digital display showing the text '3LF.26' in a segmented font, enclosed in a rectangular border.

This parameter has been removed starting with LF.81 software date 1811.4.

2LF26 Fault Codes

Display	Description	Fault cause and solution
conn	Serial Com. Established	Position values are being transferred to the encoder, encoder and serial interface are working.
EncId	Unknown encoder ID	Encoder is an unknown type and does not support the required serial communication protocol. Encoder is the wrong type, i.e. EnDat connected to a HIPERFACE feedback card. Solution: verify encoder type.
bdCbi	Cable break. inc. channels	The interface looks at each incremental channel for the idle voltage value of 2.5V with reference to common (pin 13). If this voltage is not present an error will be triggered with this fault code. Solution: check all signal connections, replace cable with new. 1)
bdCba	Cable break. abs. channels	The interface looks at each data or clock channel for the idle voltage value of 2.5V with reference to common (pin 13). If this voltage is not present an error will be triggered with this fault code. Solution: check all signal connections, replace cable with new. 1)
PoSde	Position deviation too high	The position deviation between the incremental channels and the absolute values is greater than 2.8 degrees. On SIN/COS the comparison is made between occurrences of the zero pulse. Too many or too few counts between the zero pulse will trigger this error. Normally, this is caused by a bad encoder cable and/or poor shielding and grounding of the cable. Solution: replace the cable. 1)
BdPPr	Enc. ppr does not match	Compares the internal value of ppr stored inside the encoder with the setting of LF.27. If they do not match this error code will be activated. Solution: verify correct encoder ppr and enter it in LF.27.
BdInt	Interface Card not recognized	The serial interface card is not recognized by the main CPU of the drive. Replace the feedback card.
bdSuP	Bad internal enc. supply	The internal power supply of the encoder has failed
OHEnc	Encoder over heat	Encoder temp is measure by the encoder and the error is passed on to the drive via serial com.
OSEnc	Encoder over speed	Actual speed has exceeded the max speed of the encoder.
ErEnc	Internal encoder failure	Internal encoder signals are incorrect or out of tolerance. Replace the encoder
ErEnc	Internal encoder failure	Replace encoder
FrEn	Formatting the encoder	The encoder will be formatted according to the prescribed structure. This will allow further read/write cycles to occur.
nEEnc	New encoder found	The feedback card has recognized that a new or different encoder is now connected to the drive. Therefore it is necessary to confirm. Reenter the values in LF.26,LF.27,LF.77. This message can also occur if the cable is incorrectly wired or the encoder is damaged. Try to swap the cables or encoders in this case.
noFrT	Encoder memory not formatted	Encoder memory structure is not valid and therefore can not be read
EncBS	Encoder is busy	The encoder is busy during data transfer and cannot accept the transmission.
OFF	No com to Enc. Card	There is no communication between the encoder and the drive.

1) If the cable is coiled up in the control panel, try uncoiling it out onto the floor in case this is the problem.

Parameter Description - Encoder Set Up

LF.27

Encoder pulse number

Unit: pulse per revolution
Value range: 256...16384 pulse per revolution
Default setting: 1024 pulse per revolution
Adjustment value: in accordance with the manufacturer specifications



If the incremental encoder pulse number is not correctly adjusted, the elevator drive can run very slowly, or over-speed is possible or other unforeseen conditions may occur. Therefore, it is absolutely necessary to adjust this parameter correctly.

LF.28

Encoder channel swap / direction

This parameter can be used to swap the two encoder channels, reverse the direction of the entire system, or both swap encoder channel and reverse the system direction. **See also section 5.11.5.**

Unit: 1
Value range: 0...3
Default setting: 0
Adjustment value: 0 nothing reversed
1 encoder change A <--> B swapped
2 motor rotation reversed
3 motor rotation reverse and A<-->B swapped



Encoder sample time

This parameter is used to adjust the sample time of the encoder feedback for calculation of the actual motor speed value. With certain motors or encoders it may be beneficial to use a time other than the factory setting. Lower values lead to higher bandwidth and faster response times of the motor. However lower values also increase the systems susceptibility to electrical noise on the encoder signal. Therefore on some systems having higher noise levels, lower values may not be suitable. If this electrical noise is a problem, the motor will produce an audible noise while running.

Unit: -

Value range: 0_5, 1, 2, 4, 8, 16, 32, 64, 128, 256 mSec

Default setting: 4 mSec

Adjusted value: based on application requirements

Example: with a 4 mSec sample time the resulting speed measurement resolution using a 1024 encoder is +/-3.5 rpm. A setting of 8 mSec gives +/-1.8 rpm.

With Sin/Cos, Hiperface, EnDat encoders see also parameter LF.76 for extended resolution adjustments.

Parameter Description - Control Settings



Control Mode

Used in conjunction with LF.2 to adjust the control method.

Unit: 1
Value range: 0...5
Default setting: 0
Adjustment values

- | | |
|---|---|
| 0 | Open loop induction motor operation for construction, inspection and test purposes only. |
| 1 | Open loop induction motor operation with sensorless motor management, Valid when LF.2 = Ab5Pd, d 5Pd, A 5Pd, 5Er5P, bn5Pd |
| 2 | Closed loop speed control. Valid when LF.2 = Ab5Pd, d 5Pd, A 5Pd, 5Er5P, bn5Pd |
| 3 | Closed loop speed control with external pre-torque input active. Valid when LF.2 = Ab5Pd, d 5Pd, A 5Pd, 5Er5P and using a load weight system to provide a pre-torque signal to the drive. Analog inputs X2A.3 and X2A.4 serve as the pre-torque input. See parameters LF.67, LF.68, and LF.69 for further adjustment. |
| 4 | Closed loop torque control. Valid when LF.2 = A tor. Both analog inputs serve as torque inputs and are internally summed together. |
| 5 | Closed loop speed control with synthesized pre-torque. Valid when LF.2 = Ab5Pd, d 5Pd, A 5Pd, 5Er5P, bn5Pd. Provide a synthesized pre-torque without a load weigher. See parameters US.17, US.18, P.LF.31 and P.LF.32 for further adjustment. |



When using induction motors, the COMBIVERT F5 can be run open loop in inspection to verify whether the encoder functions normally. By setting the parameter LF.30 = 0, the inverter runs the motor open loop. The encoder feedback (motor speed) is displayed in parameter LF.89 but has no effect on the operation of the motor. Therefore, this mode can be used to verify whether the encoder is functioning properly. Generally, when running empty car up the actual motor speed in LF.89 should be equal to the set speed in LF.88. If these values are off by more than 20 rpm when running empty car up, there is most likely an encoder or encoder cable problem.

When using permanent magnet synchronous motors only closed loop operation (2,3,4,5) is permitted.



Running the COMBIVERT open loop, in automatic mode, at high speed or leveling speed can result in high motor currents and or poor performance. Always verify that this parameter is set correctly before running in automatic mode!

A.LF.31

Kp speed accel.

The proportional gain of the speed controller is split into two values, one for acceleration and constant run and one for deceleration. This provides the greatest degree of flexibility. The default values are set the same for both and will work for most applications. However if the motor does not track the speed command tight enough, then the value should be increased. If the motor makes audible noise or vibration in the car, then the gain value should be reduced. Adjustment steps of +/- 250 are reasonable.

d.LF.31

Kp speed decel.

Unit: 1

Value range: 1...32767

Default setting: 3000 Accel. , 3000 Decel. , 2000 Pre-torque

P.LF.31

Kp speed synthetic pretorque

Refer to section 5.12.3 for adjustment information on A.LF.31 and d.LF.31.

The synthetic pre-torque gain setting is used to provide control during the pre-torque phase only when LF.30 =5. In most cases it is not necessary to adjust the proportional gain. However, if a vibration is felt in the car during the pre-torque phase this gain can influence it. Try values of 500, 1000, 4000, and 6000 to determine whether or not there is any influence. **P.LF.31 is not used when LF.30=3.**

A.LF.32

Ki speed accel.

The integral gain of the speed controller is split into two values, one for acceleration and constant run and one for deceleration. The default values are a good starting point and will work for most applications. Higher integral values can lead to pulsation during acceleration and deceleration.

d.LF.32

Ki speed decel.

Unit: 1

Value range: 1...32767

Default setting: 350 Accel. , 250 Decel. , 10000 Pre-torque

P.LF.32

Ki speed synthetic pretorque

Refer to section 5.12.3 for adjustment information on A.LF.32 and d.LF.32.

The sythetic pre-torque gain setting controls the rate of the build of torque and the stiffness of the motor as the brake releases only if LF.30=5. Once the pre-torque timing is adjusted, this gain can be adjusted to control the strength of the pre-torque. In general lower spring tension and lower brake pick voltages result in a smoother transition of the load from brake to motor. This gain should be adjusted as high as necessary to prevent the sheave from moving during break release. Typical values are between 5,000 and 20,000. If the value gets too high, vibration or audible noise in the motor may occur during the pre-torque phase. Refer to section 5.12.4 for more adjustment information. **P.LF.32 is not used when LF.30=3.**

Parameter Description - Control Settings



**Ki speed
offset accel.**

This gain value is effective only at low speeds. This value is added to the I term gain in LF.32 to provide greater control and more stability.



**Ki speed
offset decel.**

This offset acceleration gain will assist the motor in catching the load during starting. It is especially important for high efficiency geared or gearless applications. Values of 2,000 to 5,000 are useful.

The offset deceleration gain will allow the system track the command speed tightly at low speed. Often lower values are required than for starting. Values of 500 to 2,000 are useful.

Unit: 1

Value range: 0...8000

Default setting: 3000 Accel. , 1000 Decel.

The offset gain value is tapered off beginning at about 8 ft/min and the offset reaches zero at 24ft/min. The corner speeds can be adjusted through parameters US.20 and US.21.

Refer to section 5.12.3 for adjustment information on A.LF.33 and d.LF.33.

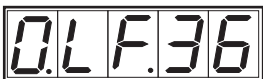

Maximum torque

The peak torque limit prevents the motor from exceeding its breakdown torque limit. If the torque limit is reached, the acceleration process will take longer with a full load. This can also cause the car to over shoot the floor during deceleration. This value can be raised.

Default Setting: 150%

The maximum output current is limited to the following:

$$\text{Max Current} = (0.LF.36 / LF.17) \times LF.12$$



The maximum output current is ultimately limited to the drive's peak current rating, regardless of how high the 0.LF.36 maximum torque may be set. Refer to Sections 2.1 and 2.2 for ratings.



The low defaults setting is to protect the motor from excessively high current which may occur during the commissioning process if there are incorrect parameter settings (e.g. motor data incorrect, encoder A/B phasing or ppr incorrect, encoder position for PM synchronous motor incorrect, etc.) The default settings should be sufficient to enable inspection operation with empty car. Under normal high speed operation, this value will likely need to be increased, typically in the range of 200-250% of rated motor torque.

**Max. torque
emergency oper.**

The maximum torque during emergency operation is activated through parameter LF.61. This allows the drive to limit the torque and therefore the output current to the rated value to prevent the drive from drawing too much current from a battery back up supply.

Unit: pound feet (lb ft)

Value range: 0.0...torque at the drive's current limit

Default setting 0.LF.36: For IM: 3 x Rated motor torque
(*approx. 3 x LF.17*)

For PM: 1.5 x Rated motor torque
(*approx. 1.5 x LF.17*)



This initial low setting protects the motor from high current in case the encoder position is wrong. For PM motors to run with 100% load in the car, it may be necessary to raise this value to 200%...250% of LF.17 based on the motor manufacturers rated peak torque.

Default setting 1.LF.36 = LF.17

Parameter Description - Control Settings



Open loop torque boost

Adjusts the torque boost only during open loop operation (LF.30=0). If the torque boost is too low the motor may not be able to lift the load. Too much or too little boost can lead to high current while running open loop.

Unit: % of input voltage
Value range: 0.0...25.5 %
Default setting: 5.0 %
Adjustment value: dependent on load, adjust incrementally.

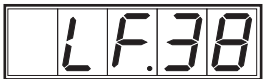

Switching frequency

Using parameter LF.38 the switching frequency of the inverter can be set. The switching frequency can be constantly 8 kHz or 16kHz with an automatic reduction based on the heat-sink temperature.



If the display often shows the error message E.OL2, then this parameter should be set to zero. Some power stages only support 8kHz. On these units it is not possible to change to this value.

Unit: 1
Value range: 0 = switching frequency constantly 8 kHz
1 = 16kHz with automatic reduction
Default setting: 0
Adjusted value: as needed

The run profile is defined by up to seven different speeds and up to three different sets of accelerations and decelerations. Various combinations of these are available depending on the mode of control adjusted in parameter LF.2. The following section describes the adjustment of the speeds and profiles.

Leveling speed, S_L

Leveling speed. The transition to zero speed is always made using the jerk adjusted in LF.56. this provides a very smooth approach to the floor. Acceleration from zero speed uses profile 1.

Unit: feet per minute
 Value range: 0...25 ft/min
 Default setting: 0 ft/min
 Adjustment value: approx. 4 ft/min

High speed, S_H

High speed. Acceleration from zero speed and deceleration to leveling or high leveling uses profile 0.

Unit: feet per minute
 Value range: 0...LF.20
 Default setting: 0 ft/min
 Adjusted value: LF.20 or smaller

Inspection speed, S_I

Inspection speed. Acceleration and deceleration rates are based on profile 1.

Unit: feet per minute
 Value range: 0... 150 ft/min or LF.20 whichever is lower
 Default setting: 0 ft/min
 Adjusted value: approx. 35 ft/min

Set Speed S_{HL} , High leveling Speed

High leveling speed or second inspection speed. Can be used for short floor or one floor travel. Acceleration is based on profile 1, which can offer independent setting from profile 0 used in high speed operation.

Unit: feet per minute
 Value range: 0...LF.20
 Default setting: 0 ft/min
 Adjusted value: dependent on use.

Parameter Description - Driving Profile

A rectangular display box divided into four segments. The first segment contains 'LF', the second contains a decimal point, the third contains '4', and the fourth contains '5'.

**Set Speed S_{INT1}
Intermediate Speed 1**

Intermediate speed one, uses profile 0 acceleration and deceleration. Can be assigned as emergency operation speed.

Unit: feet per minute
Value range: 0...LF.20
Default setting: 0 ft/min
Adjusted value: dependent on the distance between the floors

A rectangular display box divided into four segments. The first segment contains 'LF', the second contains a decimal point, the third contains '4', and the fourth contains '6'.

**Set Speed S_{INT2}
Intermediate Speed 2**

Intermediate speed two, uses profile 0 acceleration and deceleration. Can be assigned as emergency operation speed.

Unit: feet per minute
Value range: 0...LF.20
Default setting: 0 ft/min
Adjusted value: dependent on the distance between the floors

A rectangular display box divided into four segments. The first segment contains 'LF', the second contains a decimal point, the third contains '4', and the fourth contains '7'.

**Set Speed S_{INT3}
Intermediate Speed 3**

Intermediate speed three, uses profile 0 acceleration and deceleration. Can be assigned as emergency operation speed.

Unit: feet per minute
Value range: 0...LF.20
Default setting: 0 ft/min
Adjusted value: dependent on the distance between the floors

The run profile is defined by jerks, acceleration, and deceleration. Each jerk, accel and decel holds three different values and is indexed through the offset number (lead number in front of the parameter number). These different values make up three different run profiles which are either assigned based on the selected speed or through another parameter. The adjustment range for each is the same although the default values vary.



When adjusting a profile, change the offset number first and then go to each parameter. The profile number will not change when switching between parameters making it easy to adjust one complete profile. Refer to section 4.3 for selecting the profile number.

In general higher values result in a hard/fast profile, while lower values give softer, slower transitions.

**Empirical values: 2.00...3.00 for retirement homes, hospitals, apartment buildings
3.00...5.00 for office buildings, banks etc.**

When LF.2 is set to AbSPd, A SPd or A Tor, the values of all profiles are automatically set to the maximum values "oFF" thus turning off the ramp generator.

When LF.2 is set d SPd or bnSPd the default values are loaded in all profiles.

Profile 2 is used for emergency operation as selected in parameter LF.61.

0LF.50

1LF.50

2LF.50

Starting jerk

Sets jerk at start of the run.

Unit: feet per second³
Value range: (calc. min.¹⁾)...32.00 ft/s³ (oFF)
Default values: Profile 0 = 3.0 ft/s³
Profile 1 = 3.5 ft/s³
Profile 2 = 1.5 ft/s³

0LF.51

1LF.51

2LF.51

Acceleration

Sets the rate of acceleration.

Unit: feet per second²
Value range: 0.30...12.0 ft/s² (oFF)
Default values: Profile 0 = 3.3 ft/s²
Profile 1 = 3.5 ft/s²
Profile 2 = 1.5 ft/s²

1) Calc.min. - The calculated minimum value depends on the value of the rated of acceleration or deceleration that the jerk must work with. Therefore the minimum jerk value is limited by the actual adjusted value of the acceleration or deceleration. If a lower jerk value is required, you must first reduce the rate of acceleration or deceleration.

Parameter Description - Driving Profile

0LF.52

1LF.52

2LF.52

Acceleration jerk

Sets the jerk during the roll into constant speed.

Unit: feet per second³

Value range: (calc. min.¹)...32.00 ft/s³ (OFF)

Default values: Profile 0 = 4.0 ft/s³

Profile 1 = 4.5 ft/s³

Profile 2 = 1.5 ft/s³

0LF.53

1LF.53

2LF.53

Deceleration jerk

Sets the jerk in the roll out of constant speed.

Unit: feet per second³

Value range: (calc. min.¹)...32.00 ft/s³ (OFF)

Default values: Profile 0 = 4.5 ft/s³

Profile 1 = 5.0 ft/s³

Profile 2 = 1.5 ft/s³

0LF.54

1LF.54

2LF.54

Deceleration

Sets the rate of deceleration.

Unit: feet per second²

Value range: 0.30...12.0 ft/s²

Default values: Profile 0 = 3.5 ft/s²

Profile 1 = 3.5 ft/s²

Profile 2 = 1.5 ft/s²

0LF.55

1LF.55

2LF.55

Approach jerk

Set the jerk during the final approach to the floor.

Unit: feet per second³

Value range: (calc. min.¹)...32.00 ft/s³ (OFF)

Default values: Profile 0 = 2.5 ft/s³

Profile 1 = 3.5 ft/s³

Profile 2 = 1.5 ft/s³

LF.56

Stop jerk

Sets the jerk and rate of deceleration during the transition from leveling speed to stop.

Unit: feet per second³

Value range: off, 0.30...32.00 ft/s³

Default value: 2.00 ft/s³

Graphical view of speed profiles
Binary speed selection (LF.2 = bnSPd)

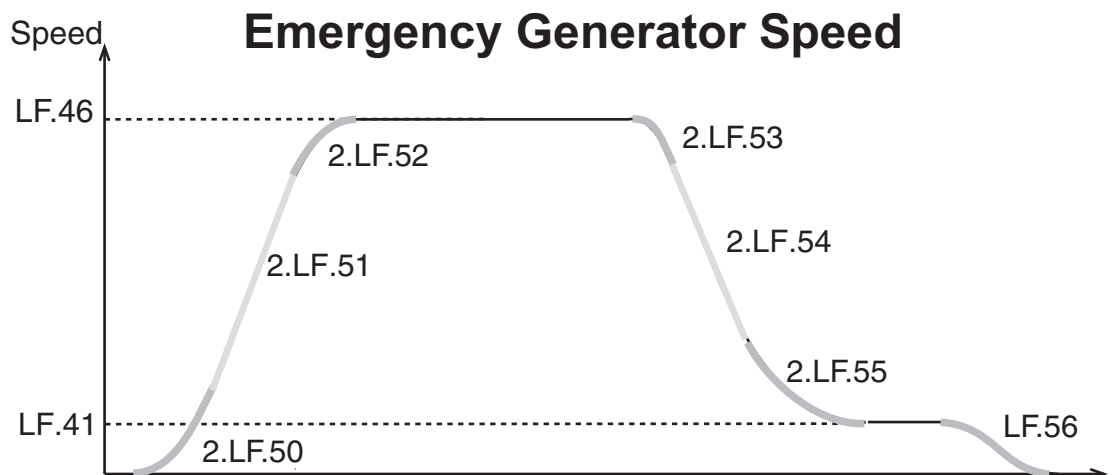
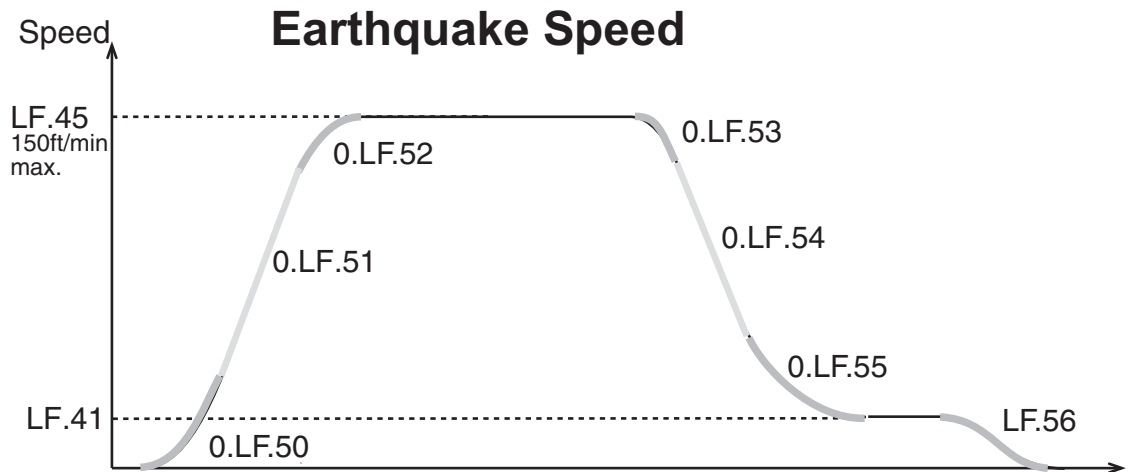
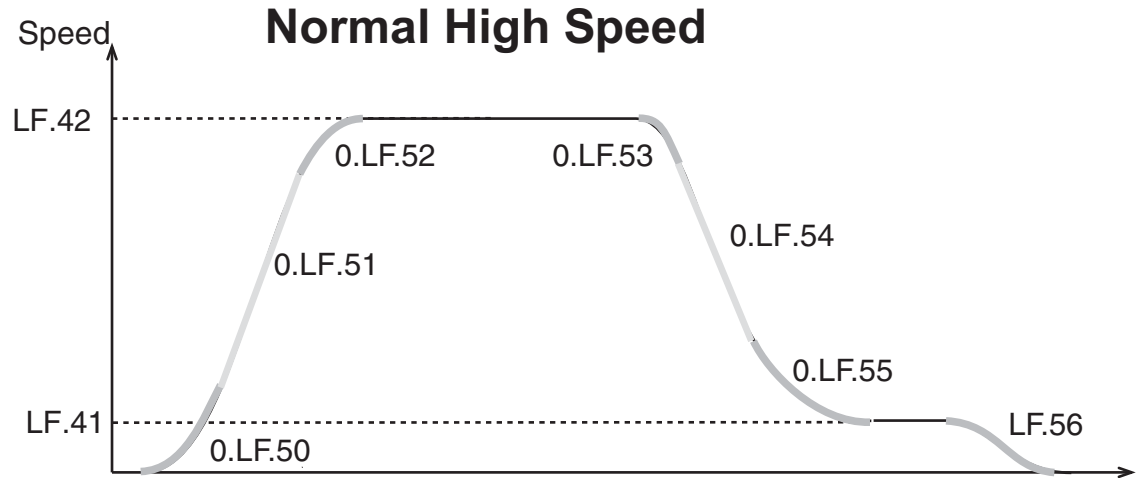

Parameter Description - Driving Profile

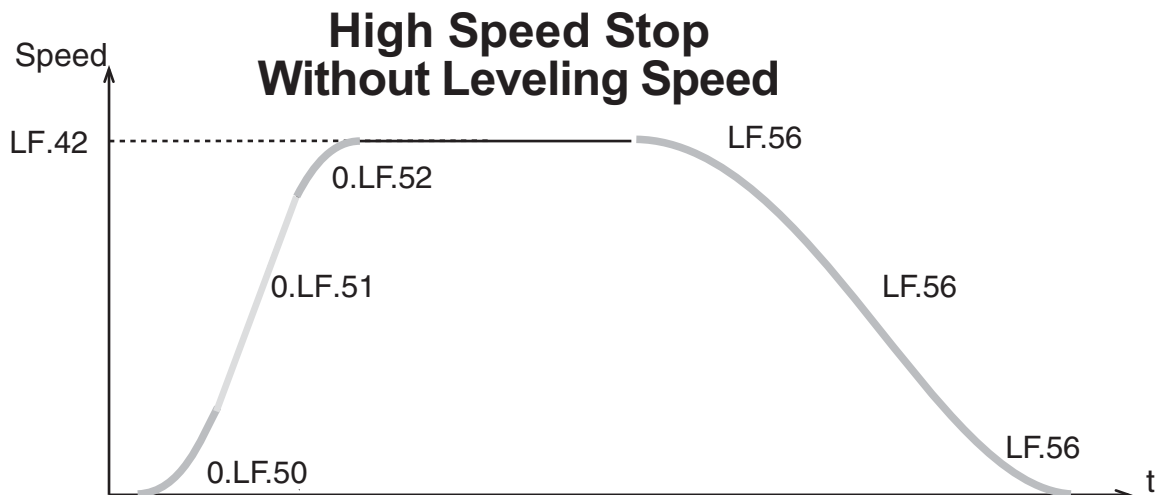
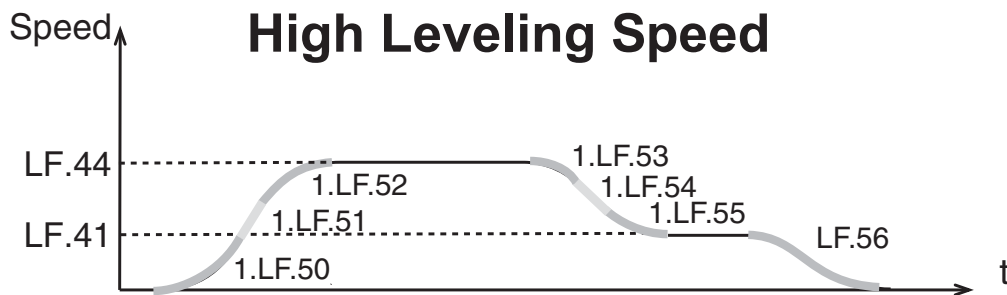
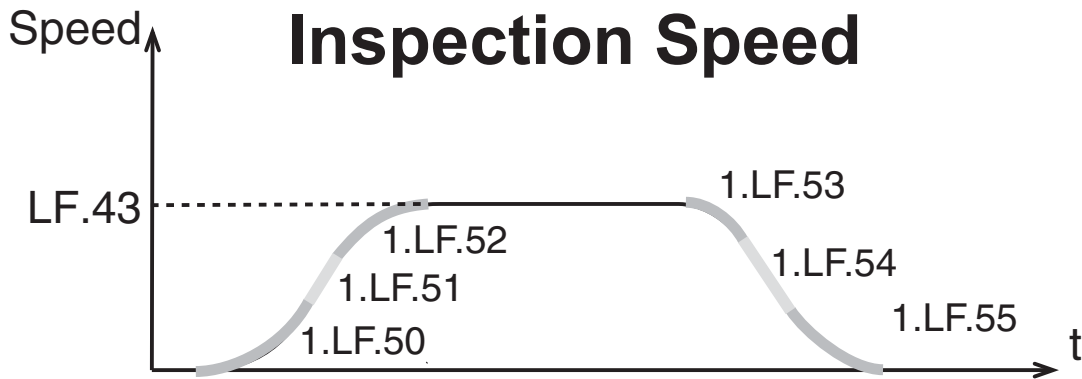

Important! If the high speed, intermediate speeds or high leveling speeds are turned off and leveling speed is not activated immediately afterward, the drive will use the stop jerk in LF.56 for the slowdown profile. This will result in a very slow deceleration of the car and may cause the car to overshoot the desired stopping point. Leveling speed must always be activated to ensure the normal deceleration profile.



Recommended Profile Settings

These are the recommended profile settings for standard 6 pole (1165 rpm) motors with geared machines. For other motors and gearless these values can also be used as a good starting point however, further adjustment may be required. The minimum jerk value is limited by the rate of acceleration or deceleration. If it is not possible to adjust the jerk rate lower, it may be necessary to lower the respective rate of acceleration or deceleration first and then try to lower the jerk.

	Contract Speed [ft/min]					
	100	150	200	250	300	350
Start Jerk LF.50 [ft/sec ³]	3.0	3.0	3.2	3.1	3.0	3.0
Acceleration LF.51 [ft/sec ²]	2.0	2.5	3.0	3.3	3.3	3.3
Accel. Jerk LF.52 [ft/sec ³]	3.25	3.5	3.75	4.0	4.0	4.0
Decel. Jerk LF.53 [ft/sec ³]	3.25	3.5	3.75	4.0	4.25	4.5
Deceleration LF.54 [ft/sec ²]	1.8	2.25	2.6	3.0	3.25	3.5
Flare Jerk LF.55 [ft/sec ³]	2.5	2.5	2.5	2.5	2.5	2.5
Stop Jerk LF.56 [ft/sec ³]	2.0	2.0	2.0	2.0	2.0	2.0

Parameter Description - Special Functions

LF.57

Speed following error

Triggers a drive warning if the actual motor speed deviates from the commanded speed by more than the window defined in parameter LF.58 and for the length of time defined in LF.59. This function only works in closed loop speed control mode, ie. LF30=2, 3 or 5.

Settings: 0 = Off (Use when LF.30 = 4)

- 1 = On, drive indicates speed following error when motor speed varies from the set speed by the amount in LF.58 and for the time in LF.59, output X2A.18 (or whichever output is programmed with R5d function).
- 2 = Can be used to trigger an external drive fault when a speed deviation occurs. For the function to work, a jumper wire must be connected between output X2A.18 (or whichever output is programmed with R5d function) and the option input X2A.10. Note however that when this is selected it is not possible to use the option input to activate emergency power mode from the same input (LF.61 = di 1). Additionally, this function is not available when LF.2 = d spd. If LF.57 = 2 and the jumper is not present, the drive will trigger the error E.EF.

LF.58

Speed difference

Sets the +/- window for the speed following error in percent of the set speed.

Unit: %
Value range: 0...30%
Default setting: 10%
Adjustment value: as necessary

LF.59

Following error timer

Defines the length of time the following error can exist before the fault is triggered.

Unit: Seconds
Value range: 0.0...1.0 sec.
Default setting: 1.0 sec.
Adjustment value: as necessary



When trying to trouble shoot the cause of this fault, it helps to increase LF.58 and LF.59 to the maximum values to prevent the fault from triggering.

LF.61

Emergency operation mode

Determines how the emergency power function is activated. The emergency power function allows the drive to run off of a UPS or battery back up system, 460V units can be run from a 230V 1 phase supply. 230V units can be run from a 230V 1 phase supply.

When active the under voltage fault level is reduced to 160VAC. The input phase failure detection is shut off, and the torque limit is reduced to the rated torque of the motor.

If a speed is programmed for this function, then whenever the speed is selected, the drive automatically goes into emergency operation. If the function is triggered by a digital input (X2A.10), the input must be active when the drive is enable and must remain active for at least one second.

Settings: Off = no function

SPd1 = Intermediate speed one serves as the emergency operation speed.

SPd2 = Intermediate speed two serves as the emergency operation speed.

SPd3 = Intermediate speed three serves as the emergency operation speed.

di 1 = Digital input X2A.10 activates the emergency operation (this mode is not possible if LF.57 =2).



Note: If a 460V unit is being powered from a 230V UPS system, the maximum car speed can be 50% of contract speed. Higher speeds will result in loss of control due to low DC bus voltage.

A setting of SPd1, SPd2 or SPd3 can not be used if the one floor positioning function (LP.1 = P onE) of the drive is activated.

LF.62

Emergency Terminal Slowdown Speed

This parameter is used to control the HSd output.

0% = standard HSd output operation

Value > 0% = HSd output acts as the ETS output

When the actual speed reaches the percentage of the contract speed set in this parameter, the ETS output will turn on. When the actual speed falls below this value, the ETS output turns off.

Unit: %
 Value range: 0% ... 100 %
 Default setting: 0 %
 Adjusted value: dependent on use

Parameter Description

LF.67

External Load Weigher Pre-torque gain

A car weighing system can be used to provide an analog signal to the elevator drive which is proportional to the load in the cabin. When LF.30 is set to 3, this analog signal is used to generate an exact counter torque to hold the car stationary when the brake is released. This is important for gearless speed control applications.

- 10 V	→ the car is empty	→ negative rated torque
0 V	→ car weight + half load = counterweight	→ 0
10 V	→ the car is full	→ positive rated torque

If the rated torque is too small or too large , it can be increased or decreased with LF.67.

Unit:	-
Value range:	0.25 ... 2.00
Default setting:	1
Adjusted value:	depends on the required torque

LF.68

External Load Weigher Pre-torque offset

If the counter weight is not 50 % (cabin weight + 50% of max. load), the pre-torque can be adjusted with LF.68.

Unit:	%
Value range:	- 100.0 % ... 100.0 %
Default setting:	0 %
Adjusted value:	depends on the counter weight

LF.69

External Load Weigher Pre-torque direction

This parameter can be used to invert the direction of the pretorque being applied to the motor.

Unit:	1
Value range:	0 => +10V = positive torque
	1 => -10v = positive torque
Default setting:	1
Adjusted value:	depends on the required torque direction



Note: Parameters LF.67-69 refer to pre-torque using an external pre-torque device (load weigher), not the drive synthetic pre-torque function. When using a load wither, LF.30 can be set to 3 to activate pre-torque.



Speed Start Delay

This time delay allows the brake to release before the motor starts turning. The drive will hold the speed command at zero, including analog commands, for the adjusted time.

Unit: seconds

Value range: 0.0...3.0 s

Default setting: 0.3 s

Adjusted value: 0.3 s



Note: When the pre-torque function is active (LF.30 = 3 or 5), the speed pick delay is the sum of the pre-torque ramp timers US.17 and US.18. Proper adjustment of these timers will automatically provide the required speed pick delay.



Brake Release Delay

This time delays the release on the brake when the BRK output is used in the brake control circuit.

Unit: seconds

Value range: 0.0...100.0 s

Default setting: 0.05 s

Adjusted value: 0.05 s

Parameter Description



Encoder resolution multiplier

This parameter can be used to increase the resolution of encoders with analog sine/cosine tracks. The encoder types are SIN/COS, Hiperface, EnDat.

Unit: 1

Value range: 0...13

Default setting: 2 for incremental encoders
8 for Sin/Cos, EnDat, or Hiperface encoders

The value corresponds to the multiplier using the following relation.

Actual Encoder Resolution = Encoder base ppr x $2^{(LF76)}$

Example: Sin/Cos encoder with base resolution of 2048 ppr.

With LF.76 = 8 the actual measured resolution is:

$$2048 \times 2^8 = 524288 \text{ counts / rev}$$

Higher values give better resolution especially for gearless applications. However higher values make the system more susceptible to disturbances due to noise. Therefore the actual value which can be used will ultimately be limited by the noise being picked up on the encoder cable.



Absolute encoder position

This parameter is only visible in closed loop PM motor mode (LF.4 = PCLSD or P9LSS). LF.77 displays the position of the encoder in relation to one of the motor poles.

Unit: 1

Value range: 0 ... 65535h

Default setting: 1000

Adjusted value: according to encoder position

If the position value is already known, simply enter the value in this parameter. If it is not known then follow the procedure in section 5.11.1, 5.11.2 or 5.11.3 to measure the position.

Brake engage time

This parameter determines how long the drive will maintain full current and control of the motor after the direction inputs, X2A.14 and X2A.15 have been turned off. After the adjusted time, motor current will continue to flow, however the analog input will be clamped and the speed control gains will be reduced. This time should be adjusted longer than the actual required time for the brake to mechanically drop.



Note: when using digital speed selection the selected speed input must be turned off before or at the same time as the direction input is turned off. When using analog or serial speed control, the command speed should be brought to zero before turning off the direction signal.

Unit: seconds
Value range: 0.00 ... 3.00 Seconds
Default setting: 0.50 Seconds

Current hold time

Once the time in LF.78 has expired, current will continue flowing to the motor, but the drive will ramp the motor torque down to zero over the time adjusted in LF.79. This provides a smooth transition of the load to the brake and a quiet de-energization of the motor. This time should be adjusted such that the drive shuts off the current before the controller drops the drive enable (X2A.16) and opens the motor contactor. If the drive enable is dropped before the current is shut off, it is possible the drive will respond with base block protection “BBL” with can prevent further operation for 1 to 3 seconds depending on the drive size. Therefore the times should be adjusted to prevent this. Additionally during this time the speed control is turned off to prevent the motor from driving against the brake.



The total time between the drop of the direction signals (X2A.14 & X2A.15) and the turn off of motor current is LF.78 + LF.79. The time delay for dropping the enable (X2A.16) and the opening of the motor contact should be greater than the sum of LF.78 and LF.79.

Unit: seconds
Value range: 0.1 ... 0.5 Seconds
Default setting: 0.3 Seconds

Diagnostic Parameters



Software version

Display of the software version of the Elevator Operator.



Software date

Display of the software date.

Format DD.MM.Y

Note: The lead character of the date may be blanked if it is a zero.

Example: data code 0208.1 display reads as 208.1

Terminal X2A



X2A Input state

This parameter displays the status of the digital inputs on terminal X2A. Each input has a specific value. See the table below for decoding.

Terminal			Description
Value	Number(s)	Function ¹⁾	
0	none	none	No signals are active on terminal X2A.10 to X2A.17
1	X2A.16	EN	Only the enable signal is active on X2A.16. Drive will not run until one of the direction signals on X2A.14 or X2A.15 are active
2	X2A.17	RST	Only the fault reset signal is active on X2A.17
4	X2A.14	U	Only the up signal is active on X2A.14. Drive will not run until enable signal on X2A.16 is active.
5	X2A.16,X2A.14	EN,U	Both the enable and up signals are active. This is normal during operation.
8	X2A.15	D	Only the down signal is active on X2.4. Drive will not run until enable signal on X2.1 is active.
9	X2A.16,X2A.15	EN,D	The enable and down signals are active. This is normal during operation.
16	X2A.10	I1	Only the option input signal at X2A.10 is active. Drive will not run until enable signal on X2A.16 and direction signal on X2A.14 or X2A.15 are active.
17	X2A.10,X2A.16	EN,I1	Both the enable and option input signals are active. A direction signal is required to allow operation.
21	X2A.10, X2A.14, X2A.16	EN,U,I1	Enable, up and option input signals are active. In analog speed mode, the drive should run.
25	X2A.10, X2A.15, X2A.16	EN,D,I1	Enable, down and option input signals are active. In analog speed mode, the drive should run.
32	X2A.11	L	Only the Leveling speed signal at X2A.11 is active. Drive will not run until enable signal on X2A.16 and direction signal on X2A.14 or X2A.15 are active.
33	X2A.11,X2A.16	EN,L	Both the Enable and Leveling speed signals are active. A direction signal is required to allow operation.
37	X2A.11, X2A.14, X2A.16	EN,U,L	Enable, Up and Leveling speed signals are active. The drive should run in binary speed mode.
41	X2A.11, X2A.15, X2A.16	EN,D,L	Enable, Down and Leveling speed signals are active. The drive should run in binary speed mode.

1) Function is described for Binary speed selection (LF.2 = bnSPd). If using digital speed selection use terminal number and table for LF.2=d SPd on page 82.

Diagnostic Parameters

Terminal			Description
Value	Number(s)	Function	
64	X2A.12	HL	Only the High Leveling speed signal at X2A.12 is active. Drive will not run until enable signal on X2A.16 and direction signal on X2A.14 or X2A.15 are active.
65	X2A.12,X2A.16	EN,HL	Both the Enable and High Leveling speed signals are active. A direction signal is required to allow operation.
69	X2A.12, X2A.14, X2A.16	EN,U,HL	Enable, Up and High Leveling speed signals are active. The drive should run in binary speed mode.
73	X2A.12, X2A.15, X2A.16	EN,D,HL	Enable, Down and High Leveling speed signals are active. The drive should run in binary speed mode.
96	X2A.11, X2A.12	INS	Only the Inspection speed signal is active. Drive will not run until enable signal on X2A.16 and direction signal on X2A.14 or X2A.15 are active.
97	X2A.11, X2A.12, X2A.16	EN,INS	Both the Enable and Inspection speed signals are active. A direction signal is required to allow operation.
101	X2A.11, X2A.12, X2A.14, X2A.16	EN,U,INS	Enable, Up and Inspection speed signals are active. The drive should run in binary speed mode.
105	X2A.11, X2A.12, X2A.15, X2A.16	EN,D,INS	Enable, Down and Inspection speed signals are active. The drive should run in binary speed mode.
128	X2A.13	H	Only the High speed signal is active. Drive will not run until enable signal on X2A.16 and direction signal on X2A.14 or X2A.15 are active.
129	X2A.13, X2A.16	EN,H	Both the Enable and High speed signals are active. A direction signal is required to allow operation.
133	X2A.13, X2A.14 X2A.16	EN,U,H	Enable, Up and High speed signals are active. The drive should run in binary speed mode.
137	X2A.13, X2A.15 X2A.16	EN,D,H	Enable, Down and High speed signals are active. The drive should run in binary speed mode.



X2A Output state

Terminal X2A

This parameter displays the status of the digital outputs on terminal X2A. Each output has a specific value. If more than one output is active, the sum of the value is displayed.

Value table:

Value	Output Terminal	Function
1	X2A.18	+24VDC Solidstate out - AS, At speed
2	X2A.19	+24VDC Solidstate out - FLT, Drive fault
4	X2A.24...26	Form C Relay - RDY, Drive Ready
8	X2A.27...29	Form C Relay - DRO, Drive On



Operation phase

Display

- 0 =
- 1 =
- 2 =
- 3 =
- 4 =
- 5 =
- 6 =
- 7 =

Speed

- Zero Speed
- Low speed selected or analog deceleration
- High speed run selected or analog start & run
- PreTorque Ramp down phase (US.18)
- PreTorque Ramp up phase (US.17)
- No Direction Selected
- no meaning
- no meaning

Diagnostic Parameters



Inverter load

Display of the actual inverter load in %. 100% equals rated load of the inverter.



Motor command speed

Displays the motor set speed in rpm, calculated from the system data.



Actual motor speed

Displays the actual motor speed in rpm measured from the motor encoder .

Actual motor speed should always be the same sign (polarity) as LF.88 and within 20 rpm. Otherwise there is a problem with the encoder, the encoder cable, or the setting of parameters LF.28.



To verify the encoder operation with induction motors, run the elevator drive in open loop (LF.30=0), set the inspection speed (LF.43) to 50% of contract speed and run the car empty up. The actual motor rpm value displayed in LF.89 should be nearly equal to the value displayed in LF.88. If the value in LF.89 varies by more than +/- 10 rpm or the value is greater or less than LF.88 by more than 20 rpm, there is a problem with either the encoder or the encoder cable.



Actual elevator speed

Display of the car speed in ft/min; only when the encoder is connected.

This is a calculated value. The car speed should always be verified with an independent measuring device.

Phase current

Display of the actual phase current.
Resolution 0.1A

Peak phase current

Maximum motor phase current that occurs during operation. Display in [A]. The value can be deleted by pressing the UP or DOWN key. The memory is also deleted when the inverter is switched off.

Actual DC voltage

Display of the actual dc-bus voltage
Resolution: 1V

Peak DC voltage

Display of the maximum dc-bus voltage measured. In addition the highest value which occurs in ru.11 is stored in ru.12. (erasing the peak storage : see parameter ru. 8).

Actual output frequency

Display of the actual output frequency.
Resolution: 0.1 Hz

Last fault

Displays the last 8 drive faults which occurred. The fault list can be viewed by changing the number to the left of the LF on the display. This number is the parameter offset number. Zero is the newest fault and 7 is the oldest. See the adjustment steps below to view the fault messages.



A list of common faults, and their causes is located in section 12.3.

Diagnostic Parameters

Error messages are always represented by an “E” in the left most position of the display. The drive fault displays are listed and described on the following pages. All faults are automatically reset up to an adjustable number of times. See parameter LF.5.

Clearing the fault history

The fault history can be cleared with the following steps:

Set the display to 0.LF.98

Press Func.

Press the up arrow and the display will change to a number.

Press up or down to scroll to the value 10.

Press enter and the history will be cleared. The message noP will be loaded into all 8 fault histories.

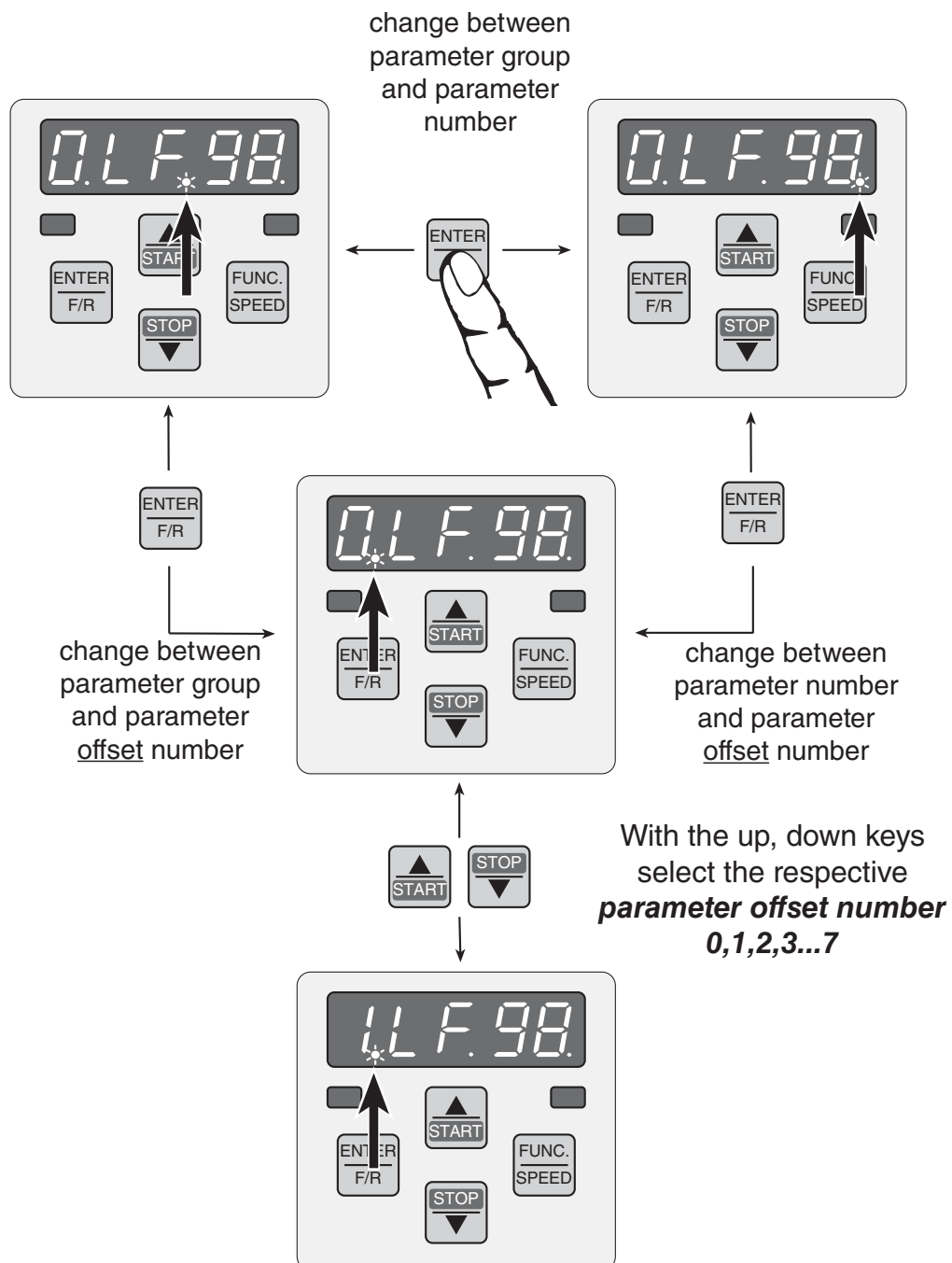



Inverter status

When the drive powers up, the default display is parameter LF.99. This parameter shows various messages indicating the current operation of the drive. Each code and its meaning is described below.

Normal Operating Messages

Display	Significance	Comments
noP	No Operation, idle state	terminal X2.1 (Drive Enable) is not set
LS	Low speed	drive is enabled but no direction of rotation is set, motor current still off
Facc	Forward acceleration	Normal run - positioning off
Fcon	Forward constant running	Normal run - positioning off
FdEc	Forward deceleration	Normal run - positioning off
rAcc	Reverse acceleration	Normal run - positioning off
rCon	Reverse constant running	Normal run - positioning off
rdEc	Reverse deceleration	Normal run - positioning off
boff	Brake OFF	Indicates brake should be in the process of releasing at beginning of run
bon	Brake ON	Indicates brake should be setting at end of run
Cdd	Calculate drive data	This message is displayed when the drive is learning the motor data or encoder position.



Refer to Section 12.1-12.3 for fault codes and trouble shooting.

Diagnostic Parameters

7.0 Run Parameters

The run parameters display operational values within the elevator drive. They can be used for trouble shooting or calibration purposes. Each parameter is listed below along with a description of what it displays. Some parameters may display information only used by factory service personnel during diagnostic or repair. It is not necessary to understand the function of each of these parameters.

ru. 0 Inverter state

This parameter displays the operational status of the inverter. The status codes are defined with parameter LF.99.

ru. 1 Set speed

This parameter displays the set speed or commanded value. This value is before the ramp generator.

Units: rpm

ru. 2 Command speed

This parameter displays the actual commanded speed of the motor. This is the speed the motor should turn at.

Units: rpm

ru. 3 Actual output frequency

This is the actual output frequency to the motor.

Units: Hz

ru. 7 Actual speed value

This is the processed actual speed value as measured by the motor encoder.

Units: rpm

ru. 9 Encoder 1 speed

This is the raw measured speed value as measured by the encoder connected to input X3A.

Units: rpm

ru.10 Encoder 2 speed

This is the raw measured speed value as measured by the encoder connected to input X3B.

Units: rpm

rU.11 Commanded torque	This is the internal torque command value which is fed into the current controller. Units: Nm
rU.12 Actual torque	This is the actual torque value which is calculated from the motor current. Units: Nm
rU.13 Actual load	This is the load level of the inverter. 100% equals rated load. Units: %
rU.14 Peak load	This is the peak load level of the inverter. 100% equals rated load. The highest value is stored. The stored value can be reset by pressing the up or down key. It will also reset when the power is turned off. Units: %
rU.15 Phase current	This is the actual phase current flowing to the motor. The currents in the three phases are averaged. Units: Amps
rU.16 Peak current	This is the peak phase current. The highest value is stored. The stored value can be reset by pressing the up or down key. It will also reset when the power is turned off. Units: Amps
rU.17 Torque current	This is the per phase value for the reflected rotor current. This current is the torque producing component of the phase current and will be proportional to the torque. Units: Amps
rU.18 DC bus voltage	This is the actual value of the DC bus voltage. Normally it will be 1.4 times higher than the input line voltage. Units: Volts
rU.19 Peak DC bus voltage	Peak DC bus voltage. The highest value is stored. The stored value can be reset by pressing the up or down key. It will also reset when the power is turned off. Units: Volts

Diagnostic Parameters

ru.20

Output voltage

This is the actual phase to phase output voltage to the motor.

Units: Volts

ru.21

Input terminal state

The raw status of the input terminals. Each input is binary weighted according to the table below. If an input is activated the value corresponding to the input is displayed. If multiple inputs are activated the sum of the values is displayed. This parameter includes software linked inputs.

<u>Input Terminal</u>	<u>Function</u>	<u>Value</u>	
X2A.16	Enable	1	Example: Input X2A.16 and X2A.14 are active. 1 + 4 = 5
X2A.17	Reset	2	
X2A.14	Up	4	
X2A.15	Down	8	
X2A.10	Option-Emerg. Pwr.	16	Other examples: 96 = Inspection speed 160 = Intermediate speed 1 192 = intermediate speed 2 224 = intermediate speed 3 + 5 for up +9 for down
X2A.11	Leveling speed	32	
X2A.12	High Level speed	64	
X2A.13	High Speed	128	
none	Internal function	256	
none	Internal function	512	
none	Internal function	1024	
none	Internal function	2048	

ru.22

Input terminal state

This is the processed status, after filters, software switches etc. of the inputs. The same weighting scheme applied as in parameter ru.21.

ru.23

Output terminal state

This is the state of the internal output conditions. Multiple active conditions results in the sum of the values.

<u>Condition</u>	<u>Value</u>
0	1
1	2
2	4
3	8
4	16
5	32
6	64
7	128

Diagnostic parameters

ru.24 Output flag state

This is the state of the internal output flags. Multiple active flags result in the sum of the values.

<u>Flag</u>	<u>Value</u>
0	1
1	2
2	4
3	8
4	16
5	32
6	64
7	128

ru.25 Output status

This is the state of the actual outputs. Multiple active outputs result in the sum of the values.

<u>Output</u>	<u>Function</u>	<u>Value</u>
X2A.18	At Speed	1
X2A.19	FLT	2
X2A.24...26	RDY	4
X2A.27...29	DRO	8
A	Software Link	16
B	Software Link	32
C	Software Link	64
D	Software Link	128

ru.26 Active parameter set

This parameter displays the active internal parameter set.

ru.27 Analog pattern raw

This parameter displays the value of the actual pattern signal applied between terminal X2A.1 and X2A.2. The value is in percent +/- 100.0% = +/- 10.00V. This value is unfiltered and unprocessed.

Units: %

ru.28 Analog pattern processed

This parameter displays the processed analog pattern value. Filters, offsets and gains are applied to this value. Again 100.0% = 10.00V on the input.

Units: %

Diagnostic Parameters

ru.29

Analog pre-torque raw

This parameter displays the value of the actual pre-torque signal applied between terminal X2A.3 and X2A.4. The value is in percent $\pm 100.0\% = \pm 10.00V$. This value is unfiltered and unprocessed.

Units: %

ru.30

Analog pre-torque processed

This parameter displays the processed analog pre-torque value. Filters, offsets and gains are applied to this value. Again $100.0\% = 10.00V$ on the input.

Units: %

ru.31

Analog option raw

This parameter displays the value of the analog signal applied to an option interface board. Again $\pm 100.0\% = \pm 10.00V$. This value is unfiltered and unprocessed.

Units: %

ru.32

Analog option processed

This parameter displays the processed analog option value. Filters, offsets and gains are applied to this value. Again $100.0\% = 10.00V$ on the input.

Units: %

ru.33

Analog Out 1 preamp

Analog output 1 preamp display. The value is in percent $\pm 100.0\% = \pm 10.00V$.

Units: %

ru.34

Analog Out 1 post-amp

Analog output 1 post amp display. The value is in percent $\pm 100.0\% = \pm 10.00V$.

Units: %

ru.35

Analog Out 2 preamp

Analog output 2 preamp display. The value is in percent $\pm 100.0\% = \pm 10.00V$.

Units: %

ru.36

Analog Out 2 post-amp

Analog output 2 post amp display. The value is in percent $\pm 100.0\% = \pm 10.00V$.

Units: %

rU.37 Motor pot value	Value of the internal function. Units:%
rU.38 Power module temperature	This is the temperature of the output transistors. Units: °C
rU.39 Overload counter	Overload counter display. Once the load of the drive goes above 100% this counter begins to increment. IF the load drops below it decrements. If the Counter reaches 100 the drive will shut down with an E.OL error.
rU.40 Power on counter	Power On counter counts the time while powered up. Units: hours
rU.41 Run counter	Run counter counts the time actual providing power to the motor and running the elevator. Units: hours
rU.42 Modulation grade	This is the percent utilization of the DC bus voltage. 100% means the DC bus is 100% utilized and the output voltage is equal to the input voltage. If this value reaches 100% or goes above 100% as a result of over modulation, loss of control of the motor will occur. Units: %
rU.43 Timer 1	Displays the value of an internal timer.
rU.44 Timer 1	Displays the value of an internal timer.
rU.45 Actual switching frequency	This is the actual carrier frequency the drive is operating at. Under certain conditions the drive may lower the carrier frequency in order to provide more current at low frequencies.

Advanced Parameters

ru.46 Motor temperature

Displays the motor temperature. This value is only valid when the motor has a KTY thermal sensor installed and that sensor is connected to the T1/T2 terminals.

Units: °C

ru.54 Position counter

Display the value of the internal position counter.

Units: counts

ru.81 Active Motor Power

This is the actual electrical power going to the motor. A negative value means power being generated by the motor.

Units: kW

ru.85 Peak Motor Speed

Displays the peak speed as measured by the motor encoder. Can be reset by pressing the down arrow key or after power off.

Units: rpm

ru.87 Magnetizing Current

Only for Induction motors, displays the actual magnetizing current. The value will drop as contract speed is reached because the flux controller is adjusting for field weakening.

Units: amps rms



All remaining ru parameters are not important for the function of the elevator drive and therefore are not documented here.

8.0 Advanced Adjustments

There are additional US parameters which can provide further functional adjustments of the drive. These US parameters are all those greater than US.10. The following will provide a basic description of the function of each parameter.

US. 16 **E.OL2 function**

The E.OL2 function is designed to protect the inverter from dangerous currents when operating at very low output frequencies. With some geared motors and mainly with gearless motors the drive is forced to provide high currents at output frequencies below 3 Hz. This causes considerable thermal loading on the power transistors. In an attempt to protect itself the drive will monitor the load current when operating below 3 Hz. If the safe value is exceeded, the drive will trigger the error E.OL2. See section 2.7 for a table with the actual current values. A value of 0 in US.16 provides this function.

A value of 16 takes into consideration the actual temperature of the power modules. If the temperature is lower, the threshold level for the output current is raised allowing more current to flow before triggering the error.

A value of 64 will cause the drive to automatically lower the carrier frequency when the output current reaches the E.OL2 limit. By doing so the actual threshold value is raised preventing E.OL2 and the drive keeps running. It is possible that under certain cases the carrier frequency might become low enough to be audible.

- 0 = Standard function E.OL2 at listed current values
- 16 = Heatsink temperature dependent E.OL2
- 64 = Auto carrier frequency reduction
- 80 = both temp dependent and auto carrier freq. reduction

Advanced Parameters

US. 17

Synthetic Pre-torque Brake Release Timer

The function of this parameter only applies to LF.30 = 5 Synthetic pre-torque.

This timer inserts dead time prior to brake release during which the current check function occurs and the motor becomes magnetized. In this case it should always be adjusted less than the actual mechanical brake pick time.

Unit: 0.1 seconds
Value range: 0.0...10.0
Default setting: 0.4

Adjustment values: (when LF.30 = 5) 1/2 of the total speed pick delay time but less than the mechanical brake pick time

Refer to section 5.12.4 for additional information on adjustment.

US. 18

Synthetic Pre-torque Hold Timer

The function of this parameter only applies to LF.30 = 5 synthetic pre-torque.

This timer controls the window during which the synthesized pre-torque function is actually active. **The mechanical release of the brake must take place during this time period.**

Unit: 0.1 seconds
Value range: 0.0...10.0
Default setting: 0.1
Adjustment values: (when LF.30 = 5) 0.1 to 0.2

Refer to section 5.12.4 for additional information on adjustment.

Refer to section 5.12.3 for additional information on how to adjust parameters US.20-23.

US. 20 Max. speed for max. KI

These parameters can be used to tailor the KI Offset gain to a specific speed range at low speed. Worm gear applications require a smaller KI Offset value but over a broader speed range. Whereas a gearless motor will require a much higher KI Offset value but at only the very lowest speed. With these two parameters the Offset can be tailored to the application. The default values are applicable to worm gear applications.

US. 21 Speed for min KI

US.20
Unit: 1 ft/min
Value range: 0..1600
Default setting: 8 ft/min

US.21
Unit: 1 ft/min
Value range: 0..1600
Default setting: 24 ft/min

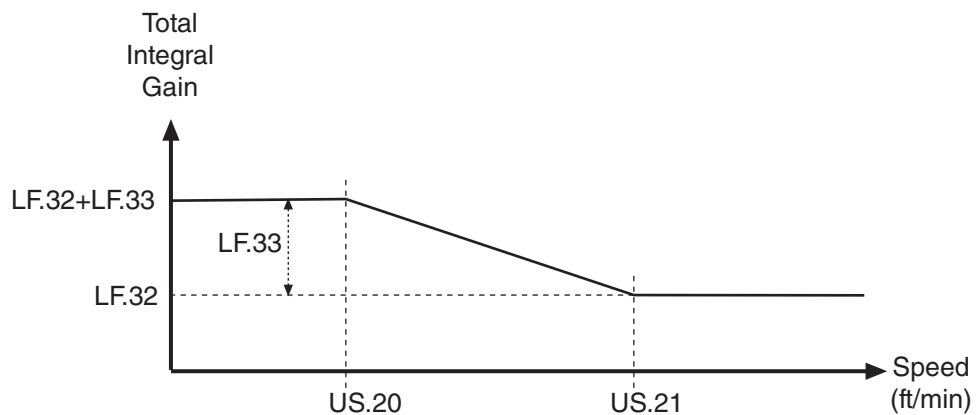

Advanced Parameters

US. 22 Speed dependent KP gain

These parameters allow the KP gain to be scaled dependent on the command speed of the elevator. In some cases it is beneficial to reduce the gain at high speed to minimize system response to hoistway vibrations or disturbances. Parameter US.22 turns the variable gain function on or off and parameter US.23 adjusts the value to which the gain is reduced.

US. 23 Min KP gain at high speed

US.22
Unit: -
Value range: off, on
Default setting: off

US.23
Unit: 1
Value range: 0..32000
Default setting: 1000

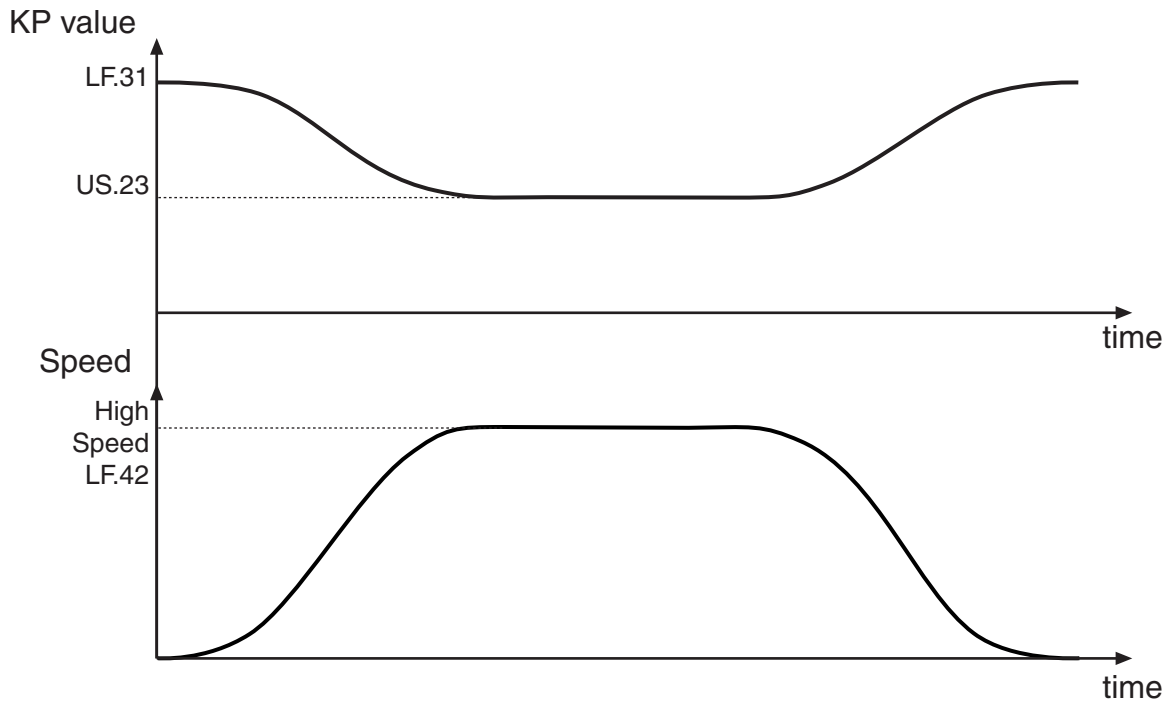

US. 24 KD speed gain

This acts as a derivative gain for the speed control. Generally the use of the derivative term is not necessary. However, there are some applications, where it could be useful. An example of which would be if for some reason it was necessary to keep the KP and KI gain values very low to prevent oscillation. In this case the KD gain could be used to maintain stability.

Unit: -
Value range: 0...32000
Default setting: 0
Recommended adjustment: 500 - 1500

US. 25 Phase current check

This parameter can be used to select what type of current check is performed. Additionally it determines whether or not the brake on/off message is displayed. In the event there is a problem getting a consistently positive phase check, it is possible to switch to only a magnetizing current check. The possibilities are defined below.

Value	Function
0	Off (for temporary adjustment only)
1	Magnetization current check with brake on/off display
2	Magnetization current check without brake on/off display
3 (default)	Phase current check with brake on/off display
4	Phase current check without brake on/off display

US. 28 Analog input noise clamp

This parameter can be used to suppress noise on the analog speed pattern. When adjusted to a value greater than zero it will act as a hysteresis level above which the analog signal must rise before the drive begins to act on it. With a negative value the drive applies the same hysteresis to constant speed, i.e. at high speed.

Unit: 0.1 % = 10mV
 Value range: 0.1...10.0 %
 Default setting: 0.1 %
 Recommended adjustment: 0.1%

US. 29 HSP5 Watchdog time

This parameter adjusts the serial watchdog on the HSP5 com. link between the operator and the drive. If the operator is removed from the drive, the serial communication stops. If it does not restart before this timer expires the drive will trigger a fault and stop the operation of the motor.



A setting of 0 or OFF turns off the watchdog allowing operation of the drive with the operator removed. Note this mode of operation is recommended only for trouble shooting purposes.

Unit: 0.01 sec
 Value range: 0.01...10.00 sec
 Default setting: 1.00 sec
 Recommended adjustment: 1.00 sec

US. 33 E.dOH function

This parameter can be used to activate the temperature sensor input (T1 and T2) on the drive. With this input activated, if the resistance between T1 and T2 becomes greater than 1650 ohms, the drive will trigger an E.dOH error indicating that the temperature sensor is too hot. Note: there is a 60 second time delay between when the sensor triggers and when the drive triggers the fault.

Value range: off...on
 Default setting: off

Advanced Parameters

US. 34 Analog pattern gain

The analog pattern can be scaled directly through this parameter. As an example if the analog signal is +/- 0...5 V, the pattern gain can be changed to 2.00 to provide full scale control of the motor speed.

Value range: 0.01...20.00
Default setting: 1.00

US. 35 Reference splitting

This function creates a slope between two successive speed values which are transferred serially. This parameter should be adjusted for a time double the actual serial update rate of the speed command. The function smooths out the relative course steps which can occur during rapidly changing speed commands.

Value range: 0:Off, 1...200 mSec
Default setting: 0:Off

US. 36 Serial Com. Baud Rate

This parameter sets the external serial communication baud rate at connector X6C. This com. port supports the DIN 66019 II standard.

Value range: 0 : 1200 bps 4 : 19200 bps
 1 : 2400 bps 5 : 38400 bps
 2 : 4800 bps 6 : 55500 bps
 3 : 9600 bps

Default setting: 5 : 38400 bps

US. 37 Function Test

This parameter allows the user to test certain functions in the drive. They are described below.

Test Name	Value	Comments
None	0 (OFF) default	
Fan Test	1	Turns on all cooling fans such that user can visually check to see they are running. Power cycle clears or set back to 0.

US. 83 Encoder 2 Output PPR

This parameter selects the output PPR for the encoder output channel X3B.

Value range: 0 : 1024 PPR
 1 : X3A Input PPR

Default setting: 0 : 1024 PPR

US. 84

Analog Output
2 Configuration

The following options in the table below can be assigned to the analog output 2. Torque is scaled such that 10V = 3 x Motor Rated Torque.

Setting	0.....+/-10V =
OFF	+/- Actual Torque
ON	Absolute Actual Torque

9.0 Input/Output Configuration

9.1 Digital Input Parameters

The digital input parameters can be used to configure the digital inputs for operation. Normally these parameters only need to be adjusted by the Elevator control builder.

di. 0 Input Type

Determines whether the inputs are PNP (sourcing) or NPN (sinking). This setting is applied globally to all inputs.

Unit: -

Value Range: PnP, nPn

Default Setting: PnP

di. 3 Noise Filter

This parameter controls a digital noise filter which can be used to mask relay bounce or other unwanted momentary signals. This filter applies to all digital inputs except the enable input at X2A.16. The enable input is processed immediately.

Unit: mSec

Value Range: 0 ... 127 mSec

Default Setting: 5 mSec

9.2 Digital Output Parameters

The digital output parameters can be used to configure the digital outputs for operation. Normally these parameters only need to be adjusted by the Elevator control builder.

do.42 Output Inversion

Can be used to invert the function of the output. As an example, normally on becomes normally off. Each output is assigned a value. To invert the output set this parameter to the corresponding value. To invert more than one output set this parameter to the sum of the values. Example X2A.18 = 1 and X2A.19 = 2, to invert both set this parameter equal to 3.

Value	Output Terminal
1	X2A.18 +24VDC solid state output
2	X2A.19 +24VDC solid state output
4	X2A.24..26 form C relay output
8	X2A.27..29 form C relay output

Unit: -
Value Range: 0...15
Default Setting: 0

do.80 Output X2A.18

This parameter determines the function of the +24VDC solid state drive output X2A.18. The function can be selected from the table on the following page.

Default Setting: R5d

do.81 Output X2A.19

This parameter determines the function of the +24VDC solid state drive output X2A.19. The function can be selected from the table on the following page.

Default Setting: FLt

do.82 Output X2A.24..26

This parameter determines the function of the relay output X2A.24..26. The function can be selected from the table on the following page.

Default Setting: rdy

do.83 Output X2A.27..29

This parameter determines the function of the relay output X2A.27..29. The function can be selected from the table on the following page.

Default Setting: dro

Input/Output Configuration

Switching conditions for the digital outputs. Only one condition can be assigned to each output.

Designator	Function
FLt	Fault - indicates there is a drive fault. Output activates when there is a drive fault, E.xxx
Rdy	Ready - indicates the drive is ready for operation. Output activates when the drive and ready for operation and there are no active faults E.xxx
dro	Drive On - indicates the drive is on and in control of the motor. Output activates after the following conditions are met: enable input active, direction input active, motor phase current check passed, motor magnetizing current OK. The output turns off when one of the following occurs: enable input is turned off, direction input is turned off and timer LF.78 has expired, drive fault E.xx, current to the motor is interrupted for any other reason.
ASd	At Speed - indicates the actual speed is tracking the command speed. Output is active as long as the actual speed matches the commanded speed. If during operation the actual speed is greater than or less than the commanded value, the output will turn off. See also parameters LF.57, LF.58, LF.59 for adjustment.
HSd	High Speed Run - indicates when the actual motor speed is above twice the value adjusted in LF. 41 (leveling speed). The output turns on when the actual speed is greater than 2 x LF.41. When the actual speed drops below 1.5 times LF.41 the output turns off. The speed is measured by the motor encoder.
brC	Brake Control - for controlling the brake. Output activates after the following conditions are met: enable input active, direction input active, motor phase current check passed, motor magnetizing current OK. The output turns off when one of the following occurs: enable input is turned off, direction input is turned off, drive fault E.xx, current to the motor is interrupted for any other reason.
Mcc	Main Contactor Control - for controlling the main motor contactor. Output activates after the following condition is met: enable input active. The output turns off when one of the following occurs: enable input is turned off, drive fault E.xx. Note: when using this input, it is necessary to qualify the direction signal(s) through an auxiliary contact on the main contact for proper timing.

9.3 Timing Graph - Analog Control

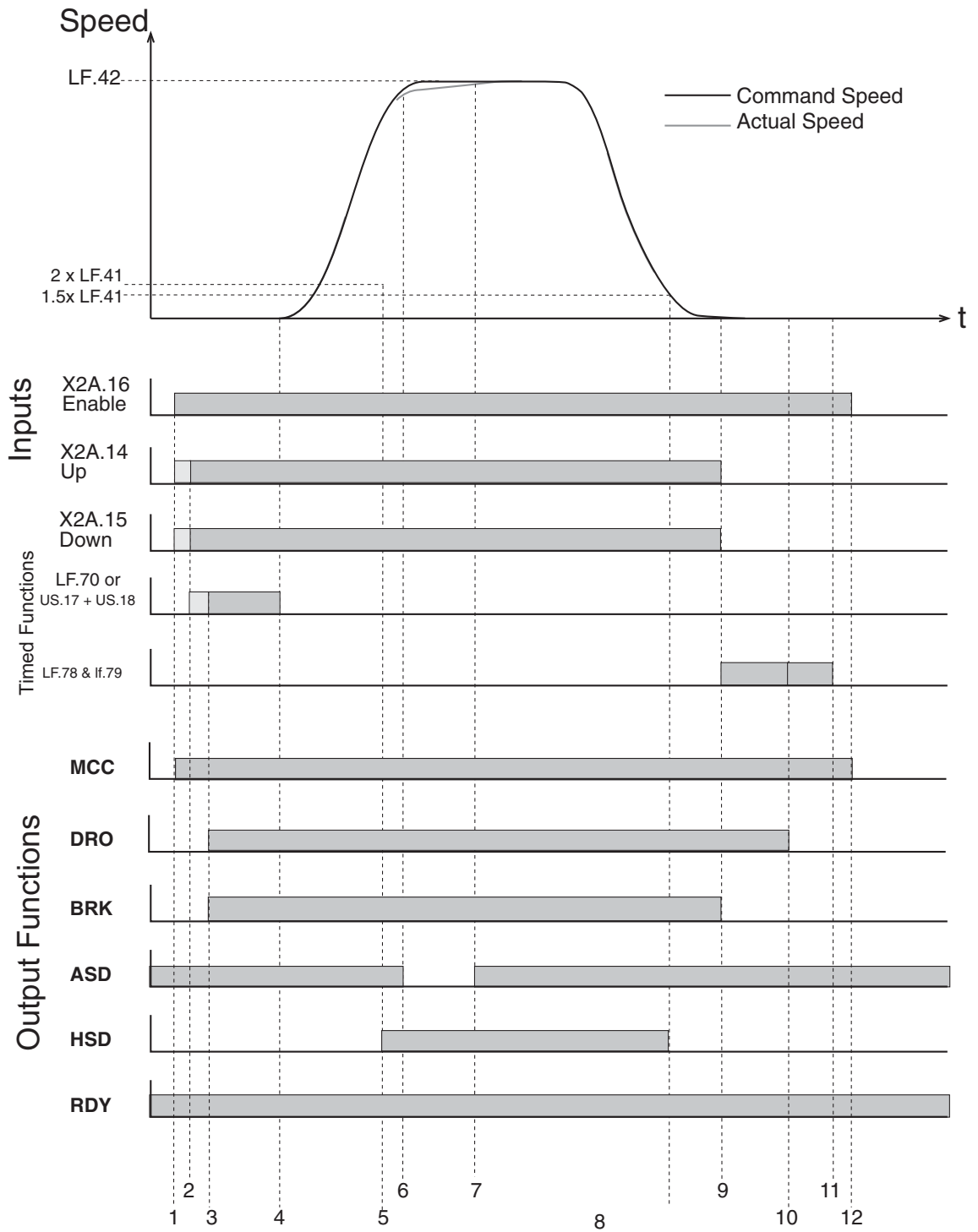

Input/Output Configuration

Event Sequence

- 1) Drive is enabled, outputs assigned to Mcc activate.
- 2) Direction signal is given. Note if Mcc output function is used, direction signals must be qualified by the closing of the main contactor.
- 3) The drive performs a current check to be sure the motor is connected and that rated magnetizing current is produced. This current check requires about 300mSec to complete.
- 4) If pretorque is not used the analog input is clamped for the period adjusted in LF.70. If pre-torque is used, the drive is applying pre-torque to the motor during this time. In either case motion can not occur so the controller must delay the pattern by at least the amount adjusted in LF.70 or the sum of the timer values in US.17 and US.18. After this time the controller can begin to ramp the analog command. This time should be adjustable to accommodate different brake release times.
- 5) Once the actual speed is above two times the leveling speed adjusted in LF.41, the HSD output function turns on.
- 6) If there is speed deviation during the run that exceeds the adjustment of LF.58 and LF.59, the ASD output turns off.
- 7) Once the speed deviation corrects itself, the ASD output turns on again.
- 8) When the elevator decelerates below, 1.5 times the leveling speed adjusted in LF.41, the HSD output turns off.
- 9) When the analog speed pattern is reaches zero, the controller should drop the direction signal. Exception, in the event of re-leveling leave the direction signal active and simply provide the re-leveling command with the analog pattern signal. When the direction turns off the timer in LF.78 begins. Additionally, the Brk output function turns off when the direction signal is turned off. If the controller is controlling the brake, the brake should be set at this time.
- 10) The drive maintains full control and current to the motor for the time period adjusted in LF.78. After which, the drive will reduce speed control gains and begin to ramp the motor current down to zero over the time adjusted in LF.79.
- 11) After the sum of the times in LF.78 and LF.79 the motor current is zero and it is safe to disable the drive and open the main contactor. Since LF.78 and LF.79 are adjustable to account for variable brake drop times, the corresponding time delay should also be adjustable in the controller.
- 12) Drive is disabled and the Mcc output turns off.

9.4 Timing Graph - Digital Control

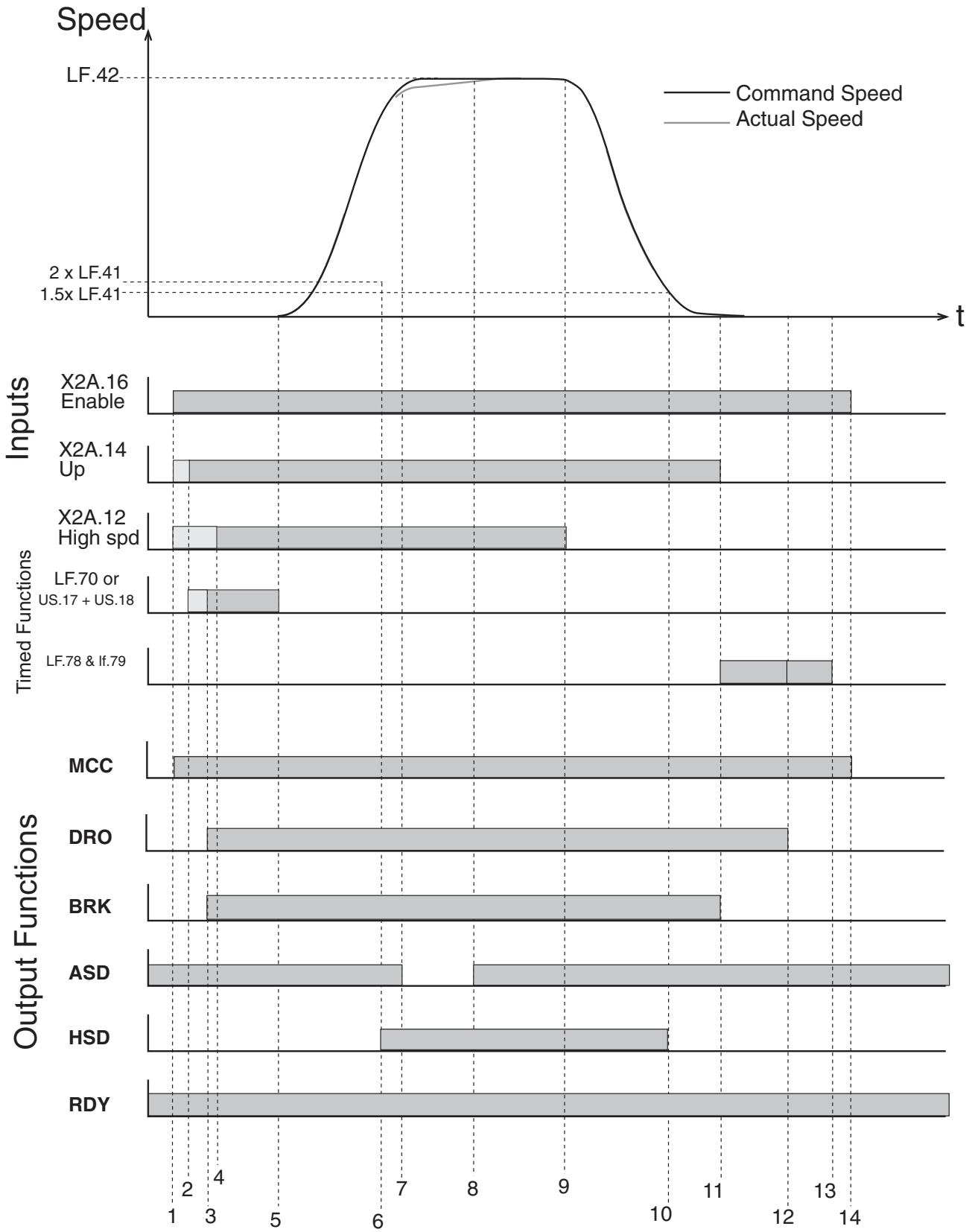

Input/Output Configuration

Event Sequence

- 1) Drive is enabled, outputs assigned to Mcc activate.
- 2) Direction signal is given. Note if Mcc output function is used, direction signals must be qualified by the closing of the main contactor.
- 3) The drive performs a current check to be sure the motor is connected and that rated magnetizing current is produced. This current check requires about 300mSec to complete.
- 4) The high speed signal is given. Note this signal can be given together with the direction signals or afterward.
- 5) If pretorque is not used the speed is held at zero the period adjusted in LF.70. If pre-torque is used, the drive is applying pre-torque to the motor during the total time in US.17 and US.18. These times are adjustable to accommodate different brake release times. The drive begins to accelerate the motor based on the adjusted pattern.
- 6) Once the actual speed is above two times the leveling speed adjusted in LF.41, the HSD output function turns on.
- 7) If there is speed deviation during the run that exceeds the adjustment of LF.58 and LF.59, the ASD output turns off.
- 8) Once the speed deviation corrects itself, the ASD output turns on again.
- 9) The high speed signal is removed and the drive begins to decelerate the elevator to the floor. Note variations in the turn off of the high speed signal will result in inconsistent approach to the floor. Therefore this signal must have minimal delay in processing from the controller.
- 10) When the elevator decelerates below, 1.5 times the leveling speed adjusted in LF.41, the HSD output turns off.
- 11) When the elevator reaches the floor, the controller should drop the direction signal. Exception, in the event of re-leveling leave the direction signal active and simply provide the re-leveling command by selecting leveling speed. When the direction turns off the timer in LF.78 begins. Additionally, the Brk output function turns off when the direction signal is turned off. If the controller is controlling the brake, the brake should be set at this time.
- 12) The drive maintains full control and current to the motor for the time period adjusted in LF.78. After which, the drive will reduce speed control gains and begin to ramp the motor current down to zero over the time adjusted in LF.79.
- 13) After the sum of the times in LF.78 and LF.79 the motor current is zero and it is safe to disable the drive and open the main contactor. Since LF.78 and LF.79 are adjustable to account for variable brake drop times, the corresponding time delay should also be adjustable in the controller.
- 14) Drive is disabled and the Mcc output turns off.

THIS PAGE LEFT BLANK.

Advanced Drive Data

10.1 Elevator Drive Data

These parameters provide access to advance elevator drive parameters related to the motor model, system mechanical model, and advanced control settings. These values should only be changed when instructed to do so by the manufacturer.

Ld.18 Field weakening corner



This parameter provides a better adjustment of the field weakening torque curve. Under certain situations, if the input voltage is sagging too low or the motor has very high slip, it is possible that the voltage limit might be reached. This can be confirmed by monitoring ru.42. If ru.42 reaches 100% or more the drive is operating at the voltage limit and potentially can cause poor control of the motor.

To prevent this from happening the drive has an adjustable torque curve which prevents the voltage limit from being reached. The value of this parameter is normally calculated when the motor data is loaded in the LF parameters. After entering the data, this value can be fine tuned.

Unit: 1 rpm

Value range: 0..4000

Default setting: calculated from motor data

Adjustment values: increment /decrement by steps of 10%

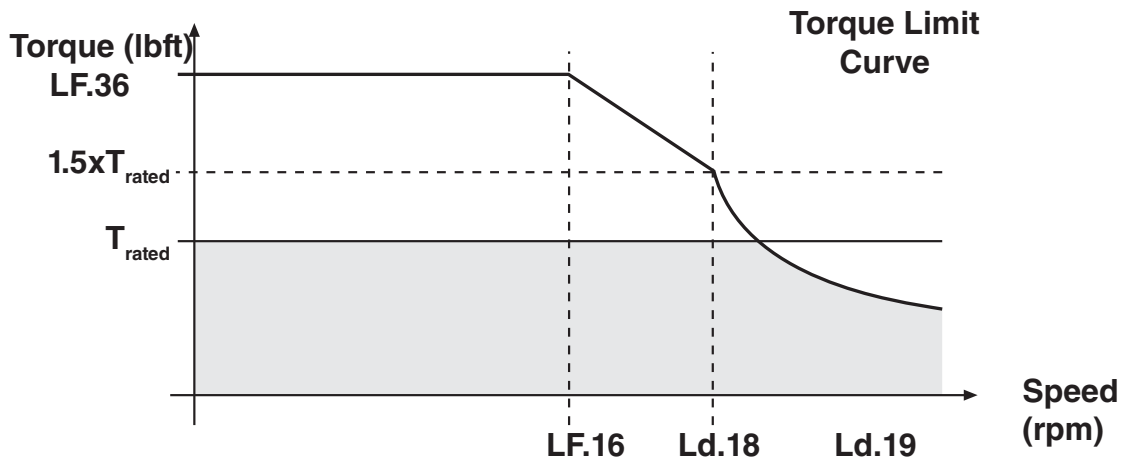

For PM motors this parameter is not required and therefore is not visible.

Ld.19 Field weakening curve



Sets the rate of decay of the motor flux above the corner speed adjusted in Ld.18. This parameter is only available for induction motors.



For PM motors this parameter is not required and therefore is not visible.

Ld.20
Stator resistance



The per phase induction motor stator resistance in ohms. This parameter is only available for induction motors.



For PM motors this parameter is not required and therefore is not visible.

Ld.21
Sigma inductance



The equivalent induction motor sigma inductance. This value is calculated from the per phase stator and rotor leakage inductances. This parameter is only available for induction motors.



For PM motors this parameter is not required and therefore is not visible.

Ld.22
Rotor resistance



This is the per phase induction motor rotor resistance. This parameter is only available for induction motors.



For PM motors this parameter is not required and therefore is not visible.

Ld.23
Magnetizing inductance

This is the per phase induction motor magnetizing inductance. This parameter is only available for induction motors. The magnetizing inductance can be monitored in parameter ru.87. If the actual magnetizing current is too high lower this inductance value in steps of 20. If it is too low, raise the value.

Ld.24
Motor control

This parameter activates various controllers in the drive. Each function is binary weighted as listed below. The sum of the these values determines which are on or off.

- 1 = Motor model control observer active
- 2 = Rotor resistance temperature adaptation
- 8 = Maximum output voltage regulation (max 110%)
- 32 = Active flux control
- 128 = Flux proofing



After the auto tuning process the motor model control observer is automatically turned on. If for any reason the auto tuning process did not provide the desired control, the function can simply be turned off by setting this parameter to 8.

Advanced Drive Data

Ld.25 Vmax regulation

Sets the output voltage level as a percentage of the available with 100% equal to the maximum available. The drive will attempt to regulate the output voltage from going above this value by reducing the magnetizing current of induction motors or de-fluxing for PM motors. The nominal value is 97% which will regulate the voltage to just under 100%.

Ld.27 KP current

Current control proportional gain. Calculated from the motor data.

Ld.28 KI current

Current control integral gain. Calculated from the motor data.

Ld.29 Acceleration torque

The acceleration torque is used to calculate the system inertia. By entering a torque value in this parameter, the corresponding inertia is calculated from the mechanical data in LF.20...LF23 and the acceleration rate adjusted in 2.LF.51. The resulting inertia value is loaded into Ld.30 and the feed forward torque control turned on. The total system inertia, motor and load in kgm^2 for gearless and kgcm^2 for geared applications. The torque value is determined by using the I Lrn function in parameter LF.3. The value is the acceleration torque minus the torque while running at contract speed. The I Lrn function will automatically bring you to this parameter to enter the torque value.

Ld.30 System inertia

This is the system inertia in kgm^2 as calculated through parameter Ld.29 or via measurements made via PC software. When this value is not equal to zero and the gain value in Ld.32 is also not equal to zero the FFTC function is active.

Ld.31 FFTC filter

Feed forward torque control filter. Provides a filter on the output of the FFTC. For digital speed or position control a value of 8 mSec is recommended. For analog control a value of 16 mSec is recommended.

Unit: -

Value range: off, 4, 8, 6, 32, 64, 128, 256, 512, 1024 mSec

Default: 0; Off

Ld.32 FFTC gain

Determines the relative gain of the feed forward torque command. 100% = unity command. A value of 90% is recommend. Higher values strengthen the response, lower values weaken the response. It may be necessary when using FFTC to lower the value of LF.32 and LF.33.

Ld.33 Torque command filter

Provides a PT1 filter on the torque command signal before it is feed into the current control.

Unit: -

Value range: off, 4, 8, 6, 32, 64, 128, 256, 512, 1024, 2048 mSec

Default: 1; 0.5ms

11.1 One Floor Position Control

These parameters are used to configure the position controller in the drive. In order to use this function, the elevator control must be designed to give the proper signal sequence ensuring correct operation.

LP.1 One floor positioning

This parameter turns the position controller on and off and also is used to activate the teach function.

Settings

OFF: Drive operates as a standard unit without positioning control

tERch: Used to learn the slowdown distance

P onE: One floor positioning is active



The general restrictions for using positioning control are as follows:

- The control mode in LF.2 must be bnSPd

- There must be an encoder on the motor and that encoder must be connected to interface X3A.

- Emergency Power Modes (LF.61 = SPd1, SPd2, SPd3,) are not available.



- Before each run at high speed the drive must be disabled and re-enabled to reset the position control.

- Re-leveling can occur at the end of the run without dropping the enable signal.

Principle of operation:

When LP.1 = P onE and high speed is selected at the beginning of the run, the drive enters positioning active (PA) mode and starts to accelerate the car up to high speed. When the car passes the slowdown sensor in the hoist way, the controller turns off the high speed command to the drive and activates either leveling or high leveling. At this moment the drive recognizes that the car is at the learned slowdown distance and then proceeds to create a slowdown profile to bring the car to the floor.

If the car is running at contract speed, the drive simply calculates the decel profile based on the adjusted values in LF.53, LF.54, LF.55, and then decelerates the car accordingly down to leveling speed. Once at leveling speed, the elevator runs until floor level is reached and then the leveling speed and direction are turned off causing the elevator to stop.

If the car is still accelerating (<80% contract speed) when the slowdown is reached (e.g. on a one floor run), the drive realizes this and calculates a profile to continue the acceleration, up to a calculated max. one floor speed and then proceeds to decelerate the elevator down to leveling speed. In this case the alternate in distance adjusted in LP.4 is used.

Position Control

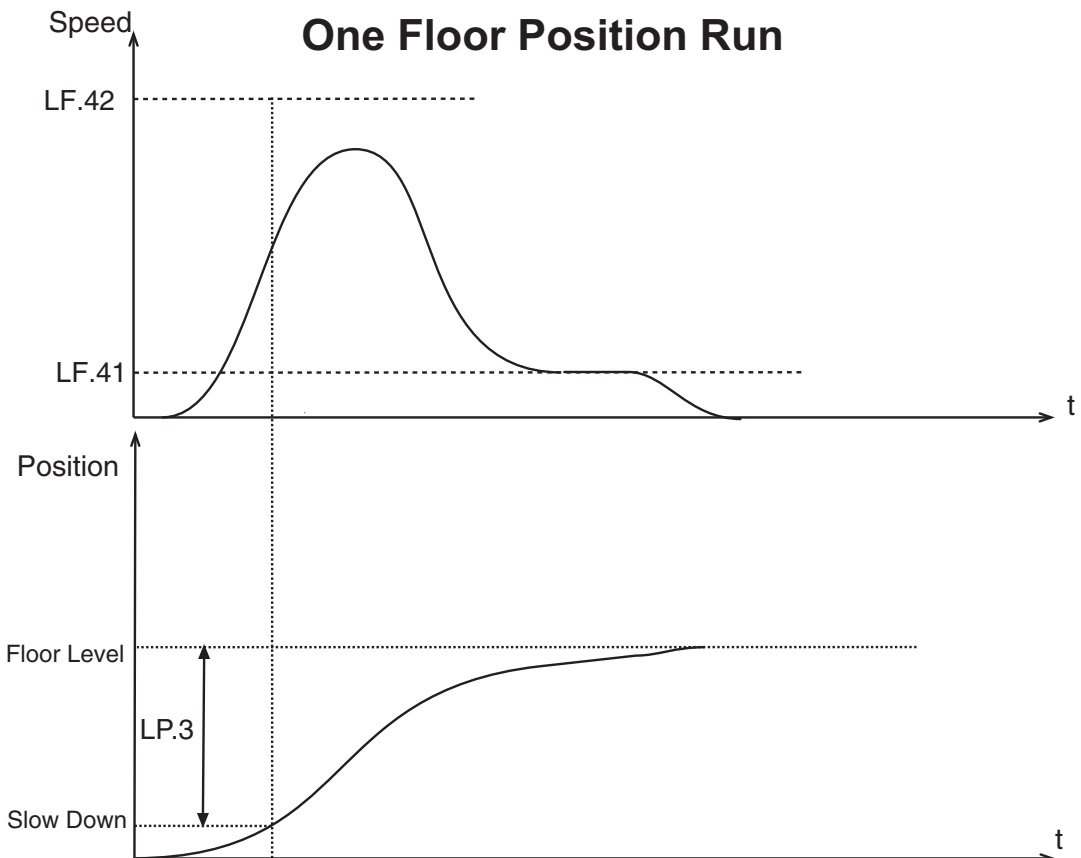
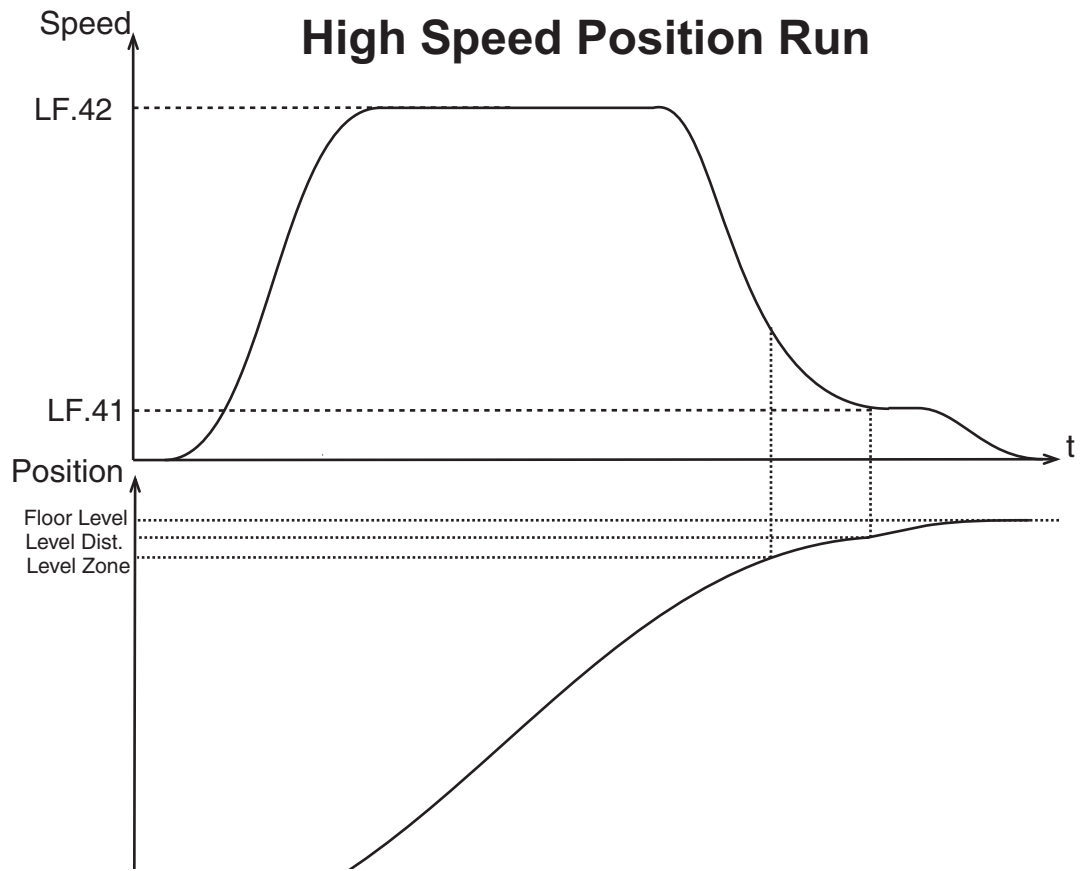

Learning the slow down distance

The actual slow down distance can be learned by the drive or it can be entered manually. However, it is recommended that the drive actually learn the distance as this will also take into account the internal delays of the controller. These delays will actually result in a lower value for the slowdown distance than that actually measured with a tape measure.

First verify that the value in LP.2 is at least 6-8 inches lower than the actual slowdown distance as measured in the hoist-way with a tape measure. This distance reduction accounts for the delay in the controller. If LP.2 is too high, adjust the profile in parameters 0.LF.53, 0.LF.54, 0.LF.55 to achieve a lower value. Note: after changing the profile parameters, LP.2 will automatically re-calculate.

Now it is possible to learn the slow down distance.

- 1) Move the car on inspection to a floor in the middle of the hoist-way.
- 2) Adjust LP.1 = tEch.
- 3) Set the display of the drive to LP.12 to view the position in inches.
- 4) Place a call up or down for a High Speed (if necessary, multi-floor) run.
- 5) As the car begins to accelerate, the position value will begin to count up or down. Then at the moment the slowdown is crossed, the position value will reset to zero and begin measuring the slowdown distance.
- 6) Once the car comes to a stop and the drive is disabled, the drive will note the actual position, subtract one inch and then load the value into parameter LP.3. It will also store the same value minus two additional inches in LP.4. As a confirmation the display will show tdone. At this point the distance has been learned.
- 7) To verify distance, set LP.1 = P onE. Change the display to LF.99.
- 8) Place a call up or down for a 1 floor run. The display should show the following sequence: noP, boFF, Fcon or rcon, PA (while the car runs to the floor all the way down to leveling speed), Fdec or rdec, rcon, ban LS, nop. The positioning is functioning normally. Now the distance in LP.4 can be manually adjusted to minimize the leveling distance. Additionally the profile can be further adjusted if needed for ride comfort. Repeat the process for a multi-floor run adjusting LP.3 to adjust the leveling distance in this case.
- 9) If the unit displays PnA and the car under- or overshoots the floor, the position is not accessible. Increase the rate of deceleration in 0.LF.54 and 0.LF.55 and then re-learn the position. If this still does not resolve the problem, it may be necessary to move the slowdown point further away from the floor.

Position Control

LP.2

Min. slowdown dist.

This parameter shows the minimum required slow down distance, based on the adjusted profile in parameters LF.53, LF.54, LF.55 and LF.42, to slow down from contract speed.

LP.3

Slowdown distance

This value is the actual distance the drive uses to calculate the actual deceleration profile. When the distance is learned, the measured value minus one inch is automatically loaded here.

LP.4

Correction distance

The corrective distance can be used to reset the position error as the car comes to the floor. When the drive sees the leveling zone marker, the position counter is reset to reflect the actual distance entered in this parameter. The controller passes the leveling zone sensor signal to the drive via drive reset X2A.17.

With this parameter the amount of stabilized leveling can be adjusted. A value of zero means no correction, the function is off and the leveling distance is the distance adjusted in the controller.

A value of 6.0", the distance of the leveling zone to the dead zone, will provide no leveling and the system will be on the verge of over shooting the floor.

The optimum adjustment for direction to the floor operation is a value of 5.7"...5.9". If a little leveling is desired set the value to 5.0"...5.5".

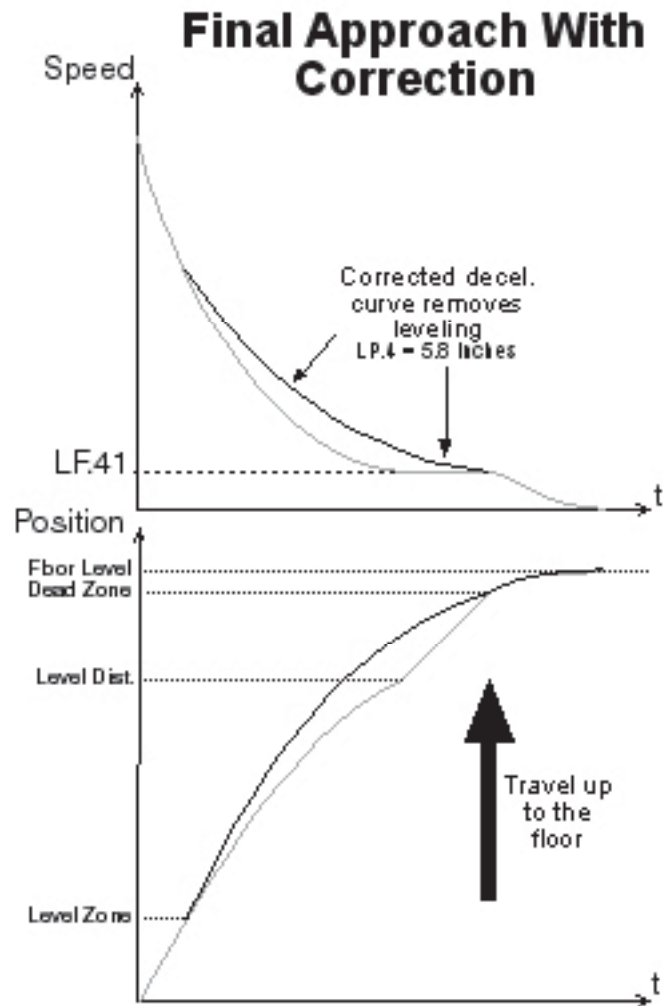

Correction distance adjustment tips

If the correction is too hard, a slight bump may be felt just as the car is coming to the floor.

Position Control

LP.12

Current position

This shows the actual position in inches from the slowdown point. When the controller gives the slowdown command by turning off high speed and enabling leveling speed the position value is reset to zero and begins to increment from there. The value displayed at the end of the run is the total distance traveled from the slowdown point.

LP.21

Scaling increments high

Parameters LP21, LP22, LP23 provide a means independent from parameters LF.20, LF.21, 22, 23 to adjust the scaling of inches into counts on the motor encoder. The scaling is defined by the following relationship:

$$\text{counts/inch} = \frac{\text{LP21} \times 10000 + \text{LP22}}{\text{LP23}}$$

LP.22

Scaling increments low

LP.23

Scaling distance

Initially these values are calculated from the values entered into parameters LF.21, LF.22, LF.23, LF.27, and LF.76. After adjusting these parameters, it is possible to change the values in LP.21,LP.22,LP.23. Keep in mind that any changes made to the LF parameters 21, 22, 23, 27 and 76 will force LP.21, 22, 23 to recalculate.

12.1 Operation Problems

Troubleshooting Operation Problems and potential solutions. Refer to Section 13.2 for additional Diagnostics Solutions. Additional troubleshooting of learn procedures are listed as well at the end of this section.

Problem	Cause/Solution/Troubleshoot
<p>Motor Does Not Move</p>	<p>Check the Motor Current. Refer to Motor Draws High Current for additional troubleshooting.</p> <p>Make sure the brake is picking and/or not dragging.</p> <p>Check the Inverter Status (LF.99) to determine whether there is indication a run command is being given (i.e. Up/Down Constant Speed/ Acceleration/Deceleration, etc.).</p> <p>Check Input Status (LF.82) to determine whether the correct inputs are being signaled for a run command.</p> <p>Check the Command Speed (LF.88) to determine what the dictated speed command is.</p> <p>For analog speed commands, check the Raw (ru.27) and Processed (Analog) Patterns (ru.28), the Contract Speed Setting (LF.20), and speed settings for any Profile.</p> <p>Check to make sure the speed control gains (KP, KI Offset) are not set too low.</p> <p>For open loop induction motors, the the Low Speed Torque Boost may need to be increased to lift the load or decreased if either the Maximum Torque of Inverter Peak Current limit is reached.</p>

Diagnostics and Troubleshooting

Problem	Cause/Solution/Troubleshoot
Motor Draws High Current	<p data-bbox="500 197 1503 268">Verify the brake picks and does not drag and that there are no other mechanical issues preventing the motor from rotating freely.</p> <p data-bbox="500 310 854 342">Verify correct motor data.</p> <p data-bbox="537 386 1511 495">For PM motors, verify the correct relationship between the Motor Rated Speed, Motor Rated Frequency and the number of motor poles Refer to Section 5.6 for further description.</p> <p data-bbox="500 537 1373 569">Perform a Motor Learn if this has not already been completed.</p> <p data-bbox="500 613 1479 762">For PM motors, verify the encoder/motor pole position is correct. Make note of the present LF.77 Encoder Pole Position value and relearn as needed. Refer to Encoder slippage/mounting (PM motors) for additional information.</p> <p data-bbox="500 806 1507 915">For PM motors, the encoder channel A/B phasing (LF.28 Swap Encoder Channels) must be correct and the encoder/rotor position learned with the correct setting.</p> <p data-bbox="500 959 1446 1068">For induction motors, set LF.30 Control Mode to Open Loop V/Hz to determine if the issue is due to encoder, encoder settings or speed control settings.</p> <p data-bbox="500 1113 1511 1184">For open loop induction motors, the Low Speed Torque Boost may need to be decreased or increased.</p>

Problem	Cause/Solution/Troubleshoot
Encoder slippage/mounting (PM motors)	<p>The position of the rotor must be known for synchronous (PM) motors for the drive to properly commutate the stator magnetic field and generate torque. Performing a encoder/rotor position learn (LF.03 = SPI or PLrn Encoder Pole Position Learn) determines a corresponding encoder position offset value for a given rotor position. The encoder is a mechanical extension of the rotor and therefore acts as an electrical commutator.</p> <p>If the mechanical relationship (eg. mounting) between the motor and encoder changes (eg. slippage), the position information from the encoder does not accurately reflect the actual rotor position resulting in the actual commutation angle being incorrect.</p> <p>When the commutation angle is not correct, more current is required to produce a given amount of torque. Large enough changes will result in very high current draw and low torque production. This leads to the motor being unable to move (stalling) or unable to hold the load (movement in direction of load, eg. empty car counterweights pull car up). In this case, the current is often reaching the corresponding 0.LF36 Maximum Torque limit or the peak current rating of the drive,</p> <p>If the encoder/rotor position is re-learned and determined to be different than the previous value of the LF.77 Encoder Pole Position by more than 4,000 counts, then this is a clear indication that the mechanical relationship between the motor and encoder has changed.</p> <p>In most cases, encoder slippage has occurred or there is an encoder mounting issue. The accumulation of slippage may occur over distance (between a few inches of movement or the entire hoistway), over time (sometimes after several years of operation), or from a change in direction (sometimes due to loose encoder mounting).</p> <p>The suggested course of action would be to first inspect the encoder mounting (in many cases, the encoder may actually be mounted tight), remove the encoder and inspect again, and re-install the encoder then relearn the encoder position (it will be different than before the encoder was removed). If issues persist, re-learn the encoder/rotor position. If large difference between learns persist (it is important to move car between learns to accumulate slippage, if this is the issue), continue to inspect the motor and encoder for mounting issues.</p>

Diagnostics and Troubleshooting

Problem	Cause/Solution/Troubleshoot
<p>Motor does not go the correct speed or cannot reach high speed.</p>	<p>Check whether the Command Speed (LF.88) and Encoder Speed (LF.89) match .</p> <p>Verify whether the Motor (Encoder) Speed is tracking the Command Speed.</p> <p>Check whether the Machine Data parameters (LF.20-25) are set correct.</p> <p>Check whether the (Voltage) Modulation Grade (ru.27) is reaching 100% . Refer to Voltage Modulation Grade limited reached for further troubleshooting.</p> <p>Check whether the Maximum Torque Limit (0.LF.36) or Inverter Peak Current limit are being reached.</p> <p>Check if the speed control gains (KP Proportional, KI Integral Offset) are set too low.</p>
<p>Overshoot into floor</p>	<p>Check the motor current, whether the Maximum Torque Limit or Inverter Peak Current limit are being reached.</p> <p>Check whether the Motor (Encoder) Speed is tracking the Command Speed.</p> <p>Check if the speed control gains (KP Proportional, KI Integral Offset) are set too low. Raise as needed.</p>
<p>Cannot lift full load</p>	<p>Check the motor current, whether the Maximum Torque Limit or Inverter Peak Current limit are being reached. Refer to Motor Draws High Current for additional troubleshooting.</p> <p>Check if the speed control gains (KP Proportional, KI Integral Offset) are set too low.</p> <p>For open loop induction motors, the Low Speed Torque Boost may need increased or decreased if reaching the Maximum Torque Limit or Inverter Peak Current.</p>
<p>Motor only moves one direction; direction of weighting (e.g. counterweights pulling up for empty car)</p>	<p>Check the motor current. Refer to Motor Draws High Current for additional troubleshooting.</p> <p>Check the Command Speed for dictated speed direction and whether is changes between directions.</p>

Problem	Cause/Solution/Troubleshoot
Motor only moves slightly or jerks briefly	<p>Check the motor current. Refer to Motor Draws High Current for additional troubleshooting.</p> <p>Refer to Motor Does Not Move for additional troubleshooting.</p>
Output current is limited (clamped)	<p>Check the setting for Maximum Torque. Refer to Peak current limit or Maximum Torque limit reached for additional troubleshooting.</p> <p>Verify the current is not being limited by the Inverter Peak Current Limit. Refer to Peak current limit or Maximum Torque limit reached for additional troubleshooting.</p> <p>Check if motor current is excessive. Refer to Motor Draws High Current for additional troubleshooting.</p>
Maximum Torque limit or Peak Current limit reached.	<p>Check the setting for Maximum Torque. For full load and/or high speed automatic operation, this value should be in the range of 200-250%.</p> <p>Note, anytime LF.17 is changed or re-entered, the Maximum Torque 0.LF.36 will automatically be reset to 150% x LF.17 when LF.04 = PgLss!</p> <p>Verify the current is not being limited by the Inverter Peak Current Limit.</p> <p>Check if motor current is excessive. Refer to Motor Draws High Current for additional troubleshooting.</p>
Motor noise (Vibration)	<p>Increase the Sample Rate for Encoder (LF.29) from 4ms (default) to 8ms.</p> <p>Verify correct motor data and whether motor learn has been performed.</p> <p>Reduce speed control gains (KP Proportional, KI Integral, KI Offset). Note, the default settings for an unroped PM motor may be too high.</p> <p>For induction motors, set the LF.30 Control Mode to Open Loop V/Hz. If the issue is still present, then it is a mechanical issue.</p> <p>Check whether the (Voltage) Modulation Grade limit is being reached (100% or above). Refer to Voltage Modulation Grade limited reached for further troubleshooting.</p>

Diagnostics and Troubleshooting

Problem	Cause/Solution/Troubleshoot
<p>Motor noise (squealing/ grinding sound), but not vibration; does not affect ride quality</p>	<p>Check whether the Sample Rate for Encoder (LF.29) is too high or too low; 4-8ms is typical.</p> <p>Check whether the setting for Encoder Multiplier Factor (LF.76) is correct. For TTL incremental encoder, this value can only be set to a value of 2; for absolute encoders (e.g. EnDat) typically found on PM motors, the setting should be a value of 8.</p> <p>Verify correct motor data. Re-enter as needed.</p> <p>Perform a motor data learn if not yet completed.</p>
<p>Unable to run induction motor in open loop.</p>	<p>For open loop induction motors, the Low Speed Torque Boost may need to be decreased or increased.</p> <p>Verify there are no mechanical issues preventing the motor from rotating freely.</p>
<p>(Voltage) Modulation Grade limit Reached</p>	<p>Verify correct wiring of the motor, in particular with motors which have multiple voltage winding arrangements (eg. dual rated 230/460V motors, wye-star/delta)</p> <p>For induction motors, reduce the Field-Weakening Corner LF.16 to 60-40% of synchronous speed (720-480 rpm for 6-pole/60 Hz motor).</p> <p>For PM motor, check the current, particularly the peak current during acceleration. Refer to Motor Draws High Current for additional troubleshooting.</p> <p>Reduce the acceleration and jerk rates into high speed.</p> <p>Verify there is not excessive sag of the DC bus during acceleration.</p>
<p>Motor turns in the wrong direction (both directions)</p>	<p>Inverter directions via LF.28. Note, do not change A-B settings (Not inverted/Swap A-B) to invert direction.</p> <p>For PM motors, do not change (U,V,W) motor phasing !</p>
<p>Clunk at end of run after brake sets</p>	<p>Verify drive enable input is not being dropped prematurely while drive is still outputting torque to motor.</p>

Problem	Cause/Solution/Troubleshoot
High peak current at either start or stop	<p data-bbox="548 212 1549 285">Check the brake timing such that the motor is not starting against the brake and that the brake is not stopping the load.</p> <p data-bbox="581 327 1533 436">For digital input speed control, the Speed Start Delay LF.70 can be extended to prevent starting under the brake. For analog and serial speed controls, this may need adjustment on the controller.</p>

Diagnostics and Troubleshooting

12.2 Diagnostic Solutions

Typical solutions in reference to operational problems in section 12.1.

Item #	Check/Solution
Monitor the Input Status to Determine Active Speed (digital input control modes)	For the given combination of inputs selected, verify which speed command is selected according to the Control Type (LF.02) and X2A Input Status (LF.82) .This should match the command speed LF.88. Verify the corresponding speed setting in the Speed Profile (LF.41-47) parameter group.
Determine the correct motor speed in rpm.	For a given command speed in FPM, the corresponding speed in rpm is calculated as: Digital Input Speed Commands: $\text{RPM} = (12 * \text{Roping Ratio} * \text{Gear Ratio} * \text{FPM}) / (\text{Sheave Diameter} * 3.14)$ Analog Speed Control: $\text{RPM} = (\text{Analog Pattern (ru.27)} * \text{Analog Pattern Gain (US.34)} * \text{Contract Speed (LF.20)} * 12 * \text{Roping Ratio} * \text{Gear Ratio} * \text{FPM}) / (\text{Sheave Diameter} * 3.14 * 100)$ Refer to US.34 (Analog Pattern Gain) and US.28 (Analog Input Noise Clamp) for calculation of Processed (Analog) Pattern from Raw (Analog) Pattern.

Item #	Check/Solution
<p>Monitor the Command Speed and Motor (Encoder) Speed</p>	<p>If the Command Speed and Motor (Encoder) Speed match, but the elevator does not travel at the correct speed:</p> <p style="padding-left: 40px;">Check Motor Command Speed (LF.88) and Actual Motor Speed (LF.89) and check whether the corresponding speed setting in (LF.41-47) parameters is correct.</p> <p style="padding-left: 40px;">Ensure the Machine Data parameters LF.20-25. Incorrect data may cause the elevator to run too fast or too slow.</p> <p style="padding-left: 40px;">If the LF.02 Control Type is analog type, verify correct LF.20 Contract Speed. LF.20 Contract Speed dictates the maximum speed corresponding to 10V.</p> <p style="padding-left: 40px;">If the LF.02 Control Type is analog type, verify the correct Raw (ru.27) and Processed (Analog) Patterns, (ru.28) Analog Pattern Gain in US.34.</p> <p>If the Motor Command Speed and Actual Motor (Encoder) Speed do NOT match:</p> <p style="padding-left: 40px;">See Check whether Maximum Torque setting is reached and high enough for normal operation.</p> <p style="padding-left: 40px;">See Check whether Inverter Maximum Current Limit is being reached.</p> <p style="padding-left: 40px;">See (Voltage) Modulation Grade limit Reached.</p>
<p>Verify correct Machine Data (LF.20-25) parameter settings.</p>	<p>The Machine Data parameters are used as a scalar to translate the command speeds programmed in FPM to an rpm value used by the drive. Incorrect setting of the machine data parameters may cause the command speed in rpm to be too high or too low.</p> <p style="padding-left: 40px;">For example, if a machine has a 1:1 roping ratio, then setting this value in the drive as 2 (:1) will cause the speeds to be calculated as twice as fast.</p> <p style="padding-left: 40px;">If the Actual Motor (Encoder) Speed (LF.89) matches the Command Speed (rpm)(LF.88), but the calculated Elevator Speed (LF.90) or the actual speed measured by hand tach (FPM) are slightly off, then the Machine Data can be adjusted slightly so the numbers agree. This would typically be done by adjusting the Gear Reduction Ratio (LF.22) or the Traction Sheave Diameter (LF.21).</p> <p>Refer to Determine the Correct Motor Speed in RPM for further details.</p>

Diagnostics and Troubleshooting

Item #	Check/Solution
Encoder/Motor Pole Position Incorrect	<p>For PM motors, the absolute encoder position indicates is used to properly indicate the position of the rotor. If the connection of the encoder to the motor shaft changes (removed/replaced, slippage, etc.), the absolute encoder position relative to the motor poles is no long valid and will require the position to be relearned. If the LF.77 Encoder Pole Position has changed by more than 2,000 from the previous value, this indicates a change in physical position relation of the encoder to the rotor, generally due to encoder slippage over time (potentially distance or change in direction as well), mounting issues, or mechanical aspects.</p> <p>When the encoder/motor pole position is incorrect, the motor will tend to draw high current, hitting the 0.LF.36 Maximum Torque setting or Inverter Peak Current Limit, and tending to stall or only move in the direction of weighting.</p>
Motor Data Incorrect	<p>Check the motor data against the nameplate values and perform a Motor Autotune LF.30= S Lrn if not previously completed.</p> <p>For PM motors, ensure the relationship between the motor rated speed, motor rated frequency and number for motor poles is correct in case of any nameplate rounding. Refer to section 5.6.2 for further details.</p>

Item #	Check/Solution
<p>Check whether Maximum Torque setting is reached and high enough for normal operation.</p>	<p>The 0.LF.36 Maximum Torque is used to limit the output current to the motor. It is primarily to protect the motor from extreme or prolonged high currents, which may occur during initial setup or troubleshooting. The limiting current can be calculated as: $(0.LF.36 \text{ Maximum Torque} / LF17 \text{ Motor Torque}) \times LF.12 \text{ Motor Current.}$</p> <p>Under normal operation, this will typically need to be set in the range of 200-250%.</p> <p>The maximum output current rating of the inverter will be the limiting factor, if reached. The 0.LF.36 Maximum Torque setting will not provide a current beyond the drive's peak rating.</p> <p>If the maximum torque limit is being reached, this may be due to:</p> <ul style="list-style-type: none"> Incorrect Motor Data. Refer to Motor Data Incorrect for additional information. Encoder Position Incorrect. Refer to Encoder/Motor Pole Position Incorrect Mechanical Issues (eg. Brake not releasing) <p>For open loop induction motors, the LF.38 Low Speed Torque Boost may be too high or too low.</p>
<p>Check whether Inverter Maximum Current Limit is being reached.</p>	<p>The drive will limit the maximum current to the inverter's peak current rating. Refer to Section 2.1 and 2.2 for ratings.</p> <p>If the peak current limit is being reached, this may be due to:</p> <ul style="list-style-type: none"> Incorrect Motor Data. Refer to Motor Data Incorrect for additional information. Encoder Position Incorrect. Refer to Encoder/Motor Pole Position Incorrect Mechanical Issues (eg. Brake not releasing) <p>For open loop induction motors, the LF.38 Low Speed Torque Boost may be too high or too low.</p>

Diagnostics and Troubleshooting

12.3 Drive Faults

Faults and error, listed alphabetically. Additional troubleshooting of operational problems is listed in Section 12.1 and diagnostics solutions in Section 12.2.

Error/Message	Description	Cause/Solution/Troubleshoot
bbL Base Block	This message precedes most faults and indicates the drive enable (X2A.16) was removed while the drive was outputting current. This is not a drive fault.	Indicates the output transistors have been safely shut off and are being blocked from further operation. This generally indicates the drive enable input (I7) was dropped prematurely or abruptly while the drive was still outputting current. This is not a drive error or fault, but a status message.
E.Cdd Error Calculate Motor Data	The inverter is unable to learn a value during the Motor Learn procedure or during automatic learn of the encoder position during each run.	Verify correct motor data is entered in LF10-17 and re-try. Make sure motor contactor is closing. Make sure motor is wired correctly. If the problem persists, contact KEB.

Error/Message	Description	Cause/Solution/Troubleshoot
E.LSF Error Charge Relay Fault	Load shunt fault	<p>Load-shunt relay has not picked up, occurs for a short time during the switch-on phase, but would automatically be reset immediately.</p> <p>If the error message remains the following causes may be applicable:</p> <ul style="list-style-type: none"> Load-shunt defective - Replace inverter Input voltage incorrect or too low Braking resistor connected to wrong terminals or braking transistor defective <p>Failure of the load shunt could result from excessive power cycling of the inverter without allowing the unit to fully power down, which may also be a result of frequent brown-outs.</p> <p>Use of a 230V single phase UPS power supply with a 480V drive is permitted and can be accomplished with the input function UPS Operation to reduce the under voltage error limit, although if the waveform is not a sine wave then the DC bus voltage may be less than the 280VDC required to reset the fault. It is suggested to let the drive power down completely before powering up with the UPS supply.</p>

Diagnostics and Troubleshooting

Error/Message	Description	Cause/Solution/Troubleshoot
EEnC1 Error Encoder1	Loss of incremental encoder channel or differential pair are the same for TTL encoders.	<p>For an incremental encoder interface , the recognition of encoder channel breakage or defective track triggers a fault if the voltage between two signal pairs (A+/A-, B+/B-, N+/N-) is smaller than 2V. That is, a signal pair cannot be at the same level. Channel pair voltages can be measured to confirm.</p> <p>If an incremental encoder does not have N+/N- (or Z+/Z-) tracks, then the corresponding inputs on the encoder interface card must be jumpered high/low. That is, jumper X3A.5 (N+) to X3B.7 (+5V) and X3A.6 (N-) to X3A.8 (0V Common). In any case, the N+/N- are not needed and these inputs could always be jumpered high/low.</p> <p>If performing a Motor Learn in open-loop, the incremental encoder interface card could be removed if an encoder is not connected.</p> <p>Verify the encoder power ratings & connections (e.g. Powering a 8-30VDC rated encoder with 5V)</p> <p>If the encoder A/B phasing is incorrect during the P Lrn (Pole Position Learn) for a PM motor, this can be changed in LF.28 Swap Encoder Channels.</p> <p>During the P Lrn (Pole Position learn), the motor must be able to move with little friction which may require either a balanced car or unroped sheave. Additionally, verify the brake is picking and fully released.</p>
EHyb Error Encoder Card	Invalid encoder interface identifier	<p>Check for correct encoder connections/pinout. Incorrect pinout may drag the encoder board power supply down.</p> <p>Check encoder card connection to control board for bent or missing pins and proper connection.</p> <p>Otherwise, the board may be defective and should be replaced.</p>
E.Hybc Error Encoder Card Changed	Indicates the encoder interface card has been changed.	<p>This error should automatically clear itself. If not, re-Enter the read-only setting in parameter 0.LF.26.</p>

Error/Message	Description	Cause/Solution/Troubleshoot
E.ENCC Error Encoder Interface	Loss of encoder channel or communication between encoder and drive for an absolute encoder.	This error should be accompanied with further information describing the nature of the fault. Refer to 2.LF.26 Encoder Status for further details.
E.BUS Error HSP5 Serial Com.	This message indicates that serial communication between the keypad operator and the drive or the drive and the elevator control has been lost (See parameter US.29 Ser.Com Watchdog Time to bypass this fault).	<p>Verify keypad operator is seated properly to the inverter.</p> <p>Verify connection of the serial comm. to the keypad operator at port X6C.</p> <p>Verify there are no bent or missing pins where the serial comm. cable from the controller plugs into the keypad operator.</p> <p>Verify serial comm. between controller and drive.</p> <p>Verify connection of keypad operator and inverter control card.</p> <p>Verify there are no bent or missing pins where the keypad operator connects to the control card.</p>
E.Br Error Low Motor Current	<p>Error current check.</p> <p>Prior to every run the drive sends current to each phase of the motor to verify the connection. Afterward, the drive applies magnetizing current (Induction Motors) and monitors whether the motor is magnetized or not.</p>	<p>Possible causes for low motor current error during current check:</p> <p>Motor contactor contacts are burnt or damaged.</p> <p>Bypass motor contactor (do not simply jumper!) to test and replace as needed.</p> <p>One or more motor leads is not connected.</p> <p>Motor contactor is not closing or not closing in time</p> <p>Bypass motor contactor or verify switching time.</p> <p>Motor windings are damaged.</p> <p>Measure motor resistance.</p> <p>The phase current check can be bypassed by setting US.25 = 0</p>

Diagnostics and Troubleshooting

Error/Message	Description	Cause/Solution/Troubleshoot
<p>E.OL2 Error Low Speed Overload</p>	<p>Occurs if the low frequency, standstill constant current is exceeded (see Technical Data for stall current levels and overload characteristics).</p> <p>The error can only be reset if the cooling time has elapsed and E.nOL2 is displayed.</p>	<p>The cause of the Low Speed Overload would be due to excessive current at low speed (typically below 3Hz). The following may be causes of excessive current:</p> <p>Incorrect motor data.</p> <p>Verify motor data , specifically the motor rated speed and frequency relationship for PM Synchronous Motors</p> <p>Verify correct encoder settings including:</p> <p>LF.27 Encoder Pulse Number</p> <p>LF.28 Swap Encoder Channels (A/B setting)</p> <p>LF.77 Encoder Pole position for PM Synchronous Motors. Relearn Encoder Pole Position as needed (see Section 5.11.1)</p> <p>High mechanical load/issues (friction) such as starting or stopping against brake.</p>
<p>E.dOH Error Motor Overheat</p>	<p>The external motor temperature sensor tripped.</p>	<p>If a motor PTC temperature sensor, relay, or KTY (special hardware required) is connected to terminals T1, T2 and the motor overheat function US.33 EdOH Function = On, then if the PTC resistance exceeds 1650 Ohms, relay opens.</p> <p>Cause of excessive motor heating may include:</p> <p>Excessive current.</p> <p>Verify correct motor data.</p> <p>Verify correct encoder settings including:</p> <p>LF.27 Encoder Pulse Number</p> <p>LF.28 Swap Encoder Channels (A/B setting)</p> <p>LF.77 Encoder Pole position for PM Synchronous Motors.</p> <p>High mechanical load/issues (friction).</p> <p>Insufficient motor cooling.</p>

Error/Message	Description	Cause/Solution/Troubleshoot
<p>E.OH2 Error Motor Protection</p>	<p>Electronic Motor Overload protection was activated.</p>	<p>Excessive RMS motor current according to the LF.08 Electric Motor Protection overload curve or if the LF09 Peak Motor Current Factor is exceeded for more than 3 seconds for PM Synchronous Motors.</p> <p>For induction motors the baseline current for Electric Motor Protection corresponds to the LM09 Electric Motor Overload Current.</p> <p>For PM Synchronous Motors the baseline current for Electric Motor Protection corresponds to the LF.12 Motor</p> <p>Causes of excessive RMS current would be:</p> <p style="padding-left: 40px;">Incorrect motor data.</p> <p style="padding-left: 80px;">Verify motor data, specifically the motor rated speed and frequency relationship for PM Synchronous Motors (see Section 5.6.2).</p> <p style="padding-left: 40px;">Verify correct encoder settings including:</p> <p style="padding-left: 80px;">LF.27 Encoder Pulse Number</p> <p style="padding-left: 80px;">LF.28 Swap Encoder Channels (A/B setting)</p> <p style="padding-left: 80px;">LF.77 Encoder Pole position for PM Synchronous Motors. Relearn Encoder Pole Position as needed (see Section 5.11)</p> <p style="padding-left: 40px;">High mechanical load/issues (friction).</p>

Diagnostics and Troubleshooting

Error/Message	Description	Cause/Solution/Troubleshoot
<p>E.OC Error Over Current</p>	<p>Occurs when the specified peak output current is exceeded or if there is a ground fault.</p>	<p>The current and peak current may be viewed in LF.93 and LF.94. To reset the logged peak value, press enter</p> <p>Causes for over current errors:</p> <p>If the error occurs instantly at the start of each run, the issue may be:</p> <ul style="list-style-type: none"> Ground fault on motor leads. Damaged or slow to close motor contactor. Shorted output transistor. Motor failure. <p>If the error is intermittent, the issue may be due to:</p> <ul style="list-style-type: none"> Damaged or slow to close motor contactor. Loose motor connections. Electrical noise, faulty grounding. <p>To determine if the over current is caused by the inverter, motor, or intermediate component (e.g. motor contactor), systematically remove these items from the system.</p> <p>Start by bypassing the motor contactor (do not simply jumper !).</p> <p>Checking of the motor and motor cables for short circuits or opens:</p> <p>Resistance checks should be done with the motor disconnected from the inverter. With the motor cable disconnected from the inverter, make a resistance check from phase to phase. This should read the winding resistance, as specified by the motor manufacture. Phase to ground resistance should read an open circuit. If measurements indicate a fault, disconnected cables at motor side and remake the test to determine if the fault is with the motor or cabling.</p> <p>...continued on next page.</p>

Error/Message	Description	Cause/Solution/Troubleshoot
EOC Error Over Current (continued)		<p>Meg tests to check motor winding insulation can only be performed with the motor disconnected from the inverter. Failure to do so will result in damage to the output section of the inverter due to high voltage from the meg tester.</p> <p>The inverter can be operated in open loop induction mode without being connected to the motor:</p> <p>Power off and after appropriate discharge time, disconnect the motor leads from the inverter.</p> <p>If not an induction motor, change motor configuration to induction motor in US10 (if US10 was previously set to a PM synchronous motor, performing this step will erase and default all parameters; make note of settings as needed before continuing), then Write Configuration to Drive in US04. Program drive as needed from default for the drive to output current when given an inspection run command.</p> <p>Set to LF.30 Control Mode = Open Loop V/Hz</p> <p>Run the system with the motor leads disconnected in open-loop. If the over current error occurs, then the inverter output is faulty. If an overcurrent error does not occur, then the fault may be in the motor, motor cabling or motor contactor.</p> <p>Notes:</p> <p>Under normal operation, the drive would limit the output to the current corresponding to the maximum torque in 0.LF36. Maximum Output Current = LF.12 Motor Current x 0.LF.36 Maximum Torque / LF.17 Motor Torque.</p> <p>The drive would also limit the output current to the hardware current limit, listed as the Peak Current (30sec.) rating in the Technical Data tables in Sec.2.1 and 2.2. The Peak Current rating will be less than the overcurrent.</p>

Diagnostics and Troubleshooting

Error/Message	Description	Cause/Solution/Troubleshoot
EOH Error Overheat Power Module	The heat sink temperature rises above the permissible limit.	<p>The heatsink temperature can be viewed in ru.38. The overheat limit is 90 degrees Celsius for most drives (See Technical Data for units 175HP and larger). Under normal operation, the heatsink temperature should usually be below 65 degrees Celsius.</p> <p>Causes of inverter heatsink overheat include:</p> <p style="padding-left: 40px;">Insufficient cooling or ambient temperature too high</p> <p style="padding-left: 80px;">Verify operation of fans.</p> <p style="padding-left: 80px;">The fans are thermostatically controlled to come on at about 45 degrees Celsius. To turn all fans on high, US.37. Function Test can be set to Fans On.</p> <p style="padding-left: 40px;">Make sure fans are not clogged.</p> <p style="padding-left: 40px;">Increase airflow around inverter or add cabinet fans.</p> <p>Faulty temperature sensor.</p> <p style="padding-left: 40px;">Power down the inverter or let it to stand idle to allow for the heatsink temperature to cool. If the heatsink temperature read by the drive for the diagnostics seems unreasonably high for a heatsink cool to the touch, then the heatsink temperature sensor may be faulty and would need to be repaired by KEB.</p>

Error/Message	Description	Cause/Solution/Troubleshoot
<p>EOL Error Overload</p>	<p>Time dependent overload (See overload curves under Technical Data, Section 2.6).</p> <p>Error can not be rest until display shows E.nOL!</p>	<p>Cause of excessive motor overload may include:</p> <p>Excessive current.</p> <p>Verify correct motor data.</p> <p>Verify correct encoder settings including:</p> <p>LF.27 Encoder Pulse Number</p> <p>LE.28 Swap Encoder Channels (A/B setting)</p> <p>LF.77 Encoder Pole position for PM Synchronous Motors.</p> <p>High mechanical load/issues (friction).</p>

Diagnostics and Troubleshooting

Error/Message	Description	Cause/Solution/Troubleshoot
E.OS Error Overspeed	The internal overspeed limit is exceeded.	<p>The inverter internal overspeed is dictated as 125% of the LF.20 Contract Speed. This level is fixed and cannot be adjusted.</p> <p>Possible causes of an overspeed error include:</p> <p>Incorrect setting of the Machine Data parameters LF.20-25.</p> <p>The Machine Data parameters are used as a scalar to convert a linear speed (e.g. ft/min) to a rotary speed (rpm) used by the inverter. If the machine data is not set correctly, the overspeed limit may be calculated too low when control modes which dictate the drive speed exceed this limit (e.g. it is possible in Serial Speed control mode for the controller to command a speed higher than the overspeed error limit calculated from the machine data parameters, which could cause inadvertent overspeed error).</p> <p>Lack of control</p> <p>Maximum Torque limit or peak inverter current reached.</p> <p>Monitor the motor current to see if it reaches a current corresponding to the 0.LF.36 Maximum Torque or the drive Peak Current rating.</p> <p>0.LF.36 Maximum Torque may be set too low (default = 150%; Typical for high speed/full load operation = 200-250%)</p> <p>...continued on next page....</p>

Error/Message	Description	Cause/Solution/Troubleshoot
<p>E.OS Error Overspeed (continued)</p>		<p style="text-align: center;">Excessive current</p> <p style="text-align: center;">Incorrect motor data, specifically the motor rated speed and frequency relationship for PM Synchronous Motors (see Section 5.6).</p> <p>Incorrect Encoder Pole Position (LF.77) for PM Synchronous Motors. Relearn Encoder Pole Position as needed (see Section 5.11)</p> <p>Speed gains set too high or low.</p> <p>For an unloaded PM Synchronous Motor, then default speed gains LF.31-33 may be too high, causing the machine to jerk quickly. If left too low for normal operation, the drive may not track the speed.</p> <p>Modulation gain exceeds maximum.</p> <p>If the modulation grade in ru42. exceeds 100% there may be a loss of speed control.</p> <p>Sudden, excessive movement.</p> <p>Incorrect motor data, specifically the motor rated speed and frequency relationship for PM Synchronous Motors (see Section 5.6).</p> <p>Incorrect Encoder Pole Position for PM Synchronous Motors. Relearn Encoder Pole Position as needed (refer to Section 5.11)</p>

Diagnostics and Troubleshooting

Error/Message	Description	Cause/Solution/Troubleshoot
<p>E.OP Error Over Voltage</p>	<p>The DC bus voltage rises above the permissible value either during motor regenerative operation or as a result of line side voltage spikes.</p> <p>For 460V drives, the over voltage level is 840VDC and for 230V drives, the over voltage level is 400VDC.</p> <p>The over voltage level cannot be adjusted.</p>	<p>The DC bus voltage LF.95 and the peak DC bus voltage LF.96 can be monitored.</p> <p>When using a braking resistor to dissipate regenerated energy from overhauling or deceleration, the braking resistor should come on at the following levels:</p> <p style="text-align: center;">460V = 760VDC 230V = 380VDC</p> <p>If a braking resistor is used:</p> <p style="padding-left: 40px;">Ensure proper connection of the braking resistor to the to the braking transistor terminals PB, ++.</p> <p style="padding-left: 40px;">Disconnect braking resistor and measure resistance to verify if correct.</p> <p>If a line regen unit is used:</p> <p style="padding-left: 40px;">By default, the line regen unit will turn on at 103% of the idle DC bus voltage.</p> <p style="padding-left: 40px;">Ensure proper connection between the drive and regen unit at the ++ and - - terminals at both units.</p> <p style="padding-left: 40px;">Ensure the regen unit is regenerating properly and is in the regen status when it should be and there no faults on the regen unit preventing operation.</p> <p>If the over voltage is due to transient voltage spikes from the line:</p> <p style="padding-left: 40px;">Install a 3-5% line reactor</p> <p>If the over voltage is due to high line voltage:</p> <p style="padding-left: 40px;">Step-down down the line voltage with a transformer.</p> <p>If there is an issue with the DC bus voltage measurement circuit:</p> <p>...continued on next page.</p>

Error/Message	Description	Cause/Solution/Troubleshoot
E.OP Error Over Voltage (continued)		<p>Measure DC bus directly and verify against DC bus voltage read from the Diagnostics screen. The DC bus should be approximately 1.41xAC Input phase-to-phase.</p> <p>If a braking resistor is used and there is an issue with the braking transistor:</p> <p>If there is an issue due to high frequency noise:</p> <p>Verify proper mains grounding.</p>
E.PU Error Power Unit	General power circuit fault	Inverter must be inspected and repaired by KEB or replaced.
E.PUCH Error Power Unit Changed	The control card recognizes a new power stage (the control card was changed).	This error should automatically clear itself.
E.PUCI Error Power Unit Invalid	During the initialization the power circuit could not be recognized or was identified as invalid	<p>This error could occur from noise.</p> <p>Disconnect terminal strip, encoder cable and serial comm. (if used) and power cycle the drive.</p> <p>Check phase-to-phase and phase-to-ground line voltages to make sure they are balanced and not causing noise.</p> <p>Re-seat ribbon connecting control card to power stage.</p>

Diagnostics and Troubleshooting

Error/Message	Description	Cause/Solution/Troubleshoot
E.UP Error Under Voltage	<p>The DC bus voltage drops below the permissible value.</p> <p>For 460V drives, the under voltage level is 240VDC and for 230V drives, the under voltage level is 216VDC.</p> <p>The under voltage level cannot be adjusted.</p>	<p>Causes for under voltage include:</p> <p>Input voltage too low or unstable.</p> <p>Verify input voltage and wiring. The DC bus should measure approximately 1.41 x AC Input phase-to-phase and should match the DC bus measurement by the drive in the Diagnostics Menu.</p> <p>One phase of the line input is missing.</p> <p>Line input phases are imbalanced. The phase-to-phase voltage measurement should not exceed 2%.</p> <p>Isolation transformer undersized or wired incorrectly.</p> <p>If there is an issue with the DC bus voltage measurement circuit:</p> <p>Measure DC bus directly and verify against DC bus voltage read from the Diagnostics screen. The DC bus should be approximately 1.41xAC Input phase-to-phase.</p> <p>Note: A 460V drive can operate on a 230V, single phase power supply if programmed for UPS mode operation.</p>
nE.OL2 no Error Low Speed Overload	No more overload.	Low speed overload has cleared and can be reset.
nE.dOH no Error Motor Overheat	Over temperature reset possible	Motor overheat sensor reset and Error Motor Overheat can be reset.
nE.OL no Error Overload	No more overload.	Overload counter has reached 0%, allowing motor to cool and the error overload error may be reset.

Error/Message	Description	Cause/Solution/Troubleshoot
no_PU Power Unit Not Ready	Control card is powered up, but the power stage is not and not seen by control card.	<p>The Power Unit Not Ready message may occur due to the following conditions:</p> <p>Control card powered up by external power supply, but drive is not powered up by line. Since the drive is not being powered by the line, the power stage cannot be identified.</p> <p>Connection issue between control card and power stage.</p> <p>For inverter housing sizes G, H, R, U, remove then reconnect the ribbon cable connecting the control card to the power stage at the control card connection.</p> <p>For inverter housing sizes D, E, remove the control card then re-seat, ensuring pin connections.</p> <p>Switching power supply.</p> <p>If reseating the ribbon cable does not resolve the issue, then there may be a failure of the switching power supply and the drive would need to be replaced or inspected and repaired by KEB.</p>
I_data	Invalid Data	Parameter outside of permissible limits
I_oPE	Invalid Operation	<p>Change Mode from Run to Stop</p> <p>Check LF.82 input status to ensure no inputs are active</p>

A.1 Parameter List Reference

Para.	Name	E	R	Res.	Lower Limit	Upper Limit	Default	Unit
LF.2	Signal/Operating Mode	E	R/W	1	1	6	6: bns pd	text
LF.3	Drive configuration	E	R/W	1	0	6	2: Stop	text
LF.4	Drive Mode	E	R	1	1	4	-	text
LF.5	Drive Fault Auto Reset	E	R/W	1	0	10	5	-
LF.8	Electronic Mtr Protection	E	R/W	1	0	1	0: OFF	text
LF.9	Electronic Mtr Protection Current	IM PM	E R/W	0.1	1	110% Rtd 300% of LF.12	8.0 300% of LF.12	A A
LF.10	Rated Motor Power	IM PM	E R/W R	0.1 0.1	0.5 0.5	125 125	5 5	hp hp
LF.11	Rated Motor Speed	E	R/W	0.1	10	6000 (500.0)	1165 (150.0)	rpm
LF.12	Rated Motor Current	E	R/W	0.1	1	110%Rtd	8	A
LF.13	Rated Motor Frequency	E	R/W	0.1	4	200 (50.0)	60 (50.0)	Hz
LF.14	Rated Motor Voltage	IM PM	E R/W	1	120	500	230/460	V
	Voltage Constant ke	PM	E	1	1	32000	1	V @ rated rpm
LF.15	Power Factor	E	R/W	0.01	0.5	1	0.9	-
LF.16	Field Weakening Speed	E	R/W	0.5	1	6000.0 (500.0)	960.0 (100.0)	rpm
LF.17	Rated Motor Torque	IM PM	E R R/W	1	1	10000	18	lb ft
LF.18	Motor Resistance	E	R/W	0.001	0	49.999	1.000	ohms
LF.19	Motor Inductance	E	R/W	0.01	0.01	500	1	mH
LF.20	Contract Speed	E	R/W	1	0	1600	0	ft/min
LF.21	Traction Sheave Diameter	E	R/W	0.01	7	80	24	inches
LF.22	Gear Reduction Ratio	E	R/W	0.01	1	250	30	-
LF.23	Roping Ratio	E	R/W	1	1	8	1	-
LF.24	Load	E	R/W	1	0	30000	0	lb
LF.25	Estimated Gear Reduction		R	0.01	0	655.35	-	-
LF.26	Type of encoder	E	R/W	1	0	32	-	-
LF.27	Encoder Pulse Number	E	R/W	1	256	16384	1024	ppr
LF.28	Swap Encoder Channels	E	R/W	1	0	3	0	-
LF.29	Sample rate for encoder	E	R/W	1	0.5	256	4	mS
LF.30	Control Mode	E	R/W	1	0	5	IM 0, PM 2	-
A.LF.31	KP Speed	E	R/W	1	1	50396	3000	-
d.LF.31	KP Speed	E	R/W	1	1	50396	3000	-
P.LF.31	KP Speed (Synth. Pre-Torque)	E	R/W	1	1	50396	2000	-
A.LF.32	KI Speed	E	R/W	1	1	26214	350	-
d.LF.32	KI Speed	E	R/W	1	1	26214	250	-
P.LF.32	KI Speed (Synth. Pre-Torque)	E	R/W	1	1	26214	10000	-
A.LF.33	KI Speed Offset	E	R/W	1	0	8000	3000	-
d.LF.33	KI Speed Offset	E	R/W	1	0	8000	1000	-
0.LF.36	Maximum Torque	E	R/W	1	0	23590	1.5 x LF17	lbft
1.LF.36	Maximum Torque	E	R/W	1	0	23590	1 x LF17	lbft
LF.37	Low Speed Torque Boost	E	R/W	0.1	0	25.5	5	%
LF.38	Switching Frequency	E	R/W	1	0	1	0	-

Parameter List Reference



Para.	Name	E	R	Res.	Lower Limit	Upper Limit	Default	Unit
LF.41	Leveling Speed	E	R/W	0.1	0	25	0	ft/min
LF.42	High Speed	E	R/W	0.1	0	LF.20	0	ft/min
LF.43	Inspection Speed	E	R/W	0.1	0	150	0	ft/min
LF.44	High Leveling Speed	E	R/W	0.1	0	25% of LF20	0	ft/min
LF.45	Intermediate Speed 1	E	R/W	0.1	0	100% of LF20	0	ft/min
LF.46	Intermediate Speed 2	E	R/W	0.1	0	100% of LF20	0	ft/min
LF.47	Intermediate Speed 3	E	R/W	0.1	0	100% of LF20	0	ft/min
LF.50	Starting Jerk	E	R/W	0.01	0.3	32.00: off	3.0	ft/s ³
LF.51	Acceleration	E	R/W	0.01	0.3	12.00: off	3.3	ft/s ²
LF.52	Acceleration Jerk	E	R/W	0.01	0.3	32.00: off	4.0	ft/s ³
LF.53	Deceleration Jerk	E	R/W	0.01	0.3	32.00: off	4.5	ft/s ³
LF.54	Deceleration	E	R/W	0.01	0.3	12.00: off	3.5	ft/s ²
LF.55	Approach Jerk	E	R/W	0.01	0.3	32.00: off	2.5	ft/s ³
LF.56	Stop Jerk	E	R/W	0.01	0.3	32.00: off	2.0	ft/s ³
LF.57	Speed Following Error	E	R/W	1	0	2	1	text
LF.58	Speed Difference	E	R/W	1	0	30	10	%
LF.59	Following Error Timer	E	R/W	0.1	0	1	1	sec
LF.61	Emergency Operation Mode	E	R/W	1	0	4	0	text
LF.67	Pretorque Gain	E	R/W	0.01	0.25	2	1	-
LF.68	Pretorque Offset	E	R/W	0.1	-100	100	0	%
LF.69	Pretorque Direction	E	R/W	1	-1	1	1	-
LF.70	Speed Start Delay	E	R/W	0.1	0	3	0.3	s
LF.71	Brake Release Delay	E	R/W	0.1	0	100	0.05	s
LF.76	Encoder Resolution Multiplier	E	R/W	1	0	13	2	-
LF.77	Absolute Encoder Position	E	R/W	1	0	65535	1000	-
LF.78	Brake Engage Time	E	R/W	0.01	0	3	0.5	s
LF.79	Current Hold Time	E	R/W	0.1	0.1	0.5	0.3	s
LF.80	Software Version		R					-
LF.81	Software Date		R					-
LF.82	X2-Input State		R	Table				-
LF.83	X2-Output State		R	Table				-
LF.86	Selected Speed		R	1	0	7		-
LF.87	Inverter Load		R	1				%
LF.88	Motor Command Speed		R	0.1				rpm
LF.89	Actual Motor Speed		R	0.1				rpm
LF.90	Actual Elevator Speed		R	1				ft/min
LF.93	Phase Current		R	0.1				A
LF.94	Peak Phase Current		R	0.1				A
LF.95	DC Bus Voltage		R	1				V
LF.96	Peak DC Bus Voltage		R	1				V
LF.97	Actual Output Frequency		R	0.1				Hz
LF.98	Last Fault		R	Table				
LF.99	Inverter State		R	Table				

Parameter List Reference

Para.	Name	E	R	Res.	Lower Limit	Upper Limit	Default	Unit
LP.1	One Floor Positioning	E	R/W	1	0:off	2 : P onE	0	-
LP.2	Maximum Slowdown Distance		R	0.1	0.0	200.0	0.0	inches
LP.3	Slowdown Distance	E	R/W	0.1	0.0	200.0	0.0	inches
LP.4	Correction Distance	E	R/W	0.1	0.0	50.0	0.0	inches
LP.12	Current Position		R	0.1	0.0	9999.9	0.0	inches
LP.21	Scaling Increments High	E	R/W	1	0	9999	0	-
LP.22	Scaling Increments Low	E	R/W	1	0	9999	0	-
LP.23	Scaling Distance	E	R/W	0.1	0.0	999.9	0	inches

Para.	Name	E	R/W	Res.	Lower Limit	Upper Limit	Default	Unit
US.00	Operator application		R	1	-	-	-	-
US.01	Password	E	R/W	1	0	9999	660	-
US.03	Default all LF parameters	E	R/W	1	1	1	0:bdPAS	-
US.04	Load configuration	E	R/W	1	1	1	0:bdPAS	-
US.10	Select Configuration	E	R/W	1	0	4	1	text
US.16	E.OL2 function	E	R/W	1	0	255	80	-
US.17	Synthetic Pre - Torque Brake Release Timer	E	R/W	0.01	0.00	32.00	0.40	sec
US.18	Synthetic Pre - Torque Hold On Timer	E	R/W	0.01	0.00	32.00	0.10	sec
US.20	max speed for max KI	E	R/W	1	0	1600	8	fpm
US.21	speed for min KI	E	R/W	1	0	1600	24	fpm
US.22	Speed Dependent KP Gain	E	R/W	1	0	1	0	-
US.23	Min KP Gain at High Speed	E	R/W	1	0	50396	1000	-
US.24	KD speed gain	E	R/W	1	0	5000	0	-
US.25	Phase Current Check	E	R/W	1	0	4	3	-
US.28	Analog Input Noise Clamp	E	R/W	0.1	-2.5	2.5	0.1	%
US.29	HSP5 Watchdog Time	E	R/W	0.01	0.0 = oFF	10.00	1.00	Sec
US.33	EdOH function	E	R/W	1	0 = off	1 = on	0	-
US.34	Analog Pattern Gain	E	R/W	0.01	0.01	20.00	1.00	-
US.35	Reference Splitting	E	R/W	1	0 (off)	200	0	mSec
US.36	External Serial Com Baud Rate	E	R/W	1	0	6	5	-
US.37	Test Function	E	R/W	1	0 (off)	1	0	-

Para.	Name	E	R	Res.	Lower Limit	Upper Limit	Default	Unit
di.0	Input type	E	R/W	1	0 = PNP	1 = NPN	0	-
di.3	Noise Filter	E	R/W	1	0	127	5	mSec

Para.	Name	E	R	Res.	Lower Limit	Upper Limit	Default	Unit
do.42	Digital Output Inversion	E	R/W	1	0	15	0	-
do.80	Output X2A.18	E	R/W	1	0	6	3	-
do.81	Output X2A.19	E	R/W	1	0	6	0	-
d0.82	Output X2A.24...26	E	R/W	1	0	6	2	-
d0.83	Output X2A.27...29	E	R/W	1	0	6	3	-

Para.	Name	E	R	Res.	Lower Limit	Upper Limit	Default	Unit
Ld.18	Field Weakening Corner	E	R/W	0.1	0.0	6000.0	83% of LF.11	rpm
Ld.19	Field Weakening Curve	E	R/W	0.01	0.01	2.00	1.20	-
Ld.20	Stator Resistance	E	R/W	0.001	0.000	50.000	1.000	ohms
Ld.21	Sigma Inductance	E	R/W	0.01	0.01	500.00	10.00	mH
Ld.22	Rotor Resistance	E	R/W	0.001	0.000	49.9999	1.000	ohms
Ld.23	Mag. Inductance	E	R/W	0.1	0.1	3276.7	100.0	mH
Ld.24	Motor Control	E	R/W	1	0	255	8	-
Ld.25	Vmax Regulation	E	R/W	1	0	110	97	%
Ld.27	KP Current	E	R/W	1	1	32767	1500	-
Ld.28	KI Current	E	R/W	1	1	32767	500	-
Ld.29	Acceleration Torque	E	R/W	1	0	25000	0	Nm
Ld.30	System Inertia	E	R/W	1	0	1073741823	0	kgcm ²
Ld.31	FFTC Filter	E	R/W	1	0	9	0	-
Ld.32	FFTC Gain	E	R/W	0.1	0.0	200.0	0.0	%
Ld.33	Torque Command Filt.	E	R/W	1	0	10	1	-

A.2 Customer Parameter Values

Para.	Name	Customer Value	Unit	Para.	Name	Customer Value	Unit
LF.02	Steering/Operating Mode			0.LF.36	Maximum Torque		lbft
LF.03	Drive configuration			1.LF.36	Max.Torq. (emergency)		lbft
LF.04	Drive Mode			LF.37	Low Speed Torque Boost		%
LF.05	Auto Reset			LF.38	Switching Frequency		-
LF.08	Electronic Mtr Protection			LF.41	Leveling Speed		ft/min
LF.09	Electronic Mtr Protection Current		A	LF.42	High Speed		ft/min
LF.10	Rated Motor Power		hp	LF.43	Inspection Speed		ft/min
LF.11	Rated Motor Speed		rpm	LF.44	High Leveling Speed		ft/min
LF.12	Rated Motor Current		A	LF.45	Intermediate Speed 1		ft/min
LF.13	Rated Motor Frequency		Hz	LF.45	Intermediate Speed 2		ft/min
LF.14	Rated Motor Voltage		V	LF.45	Intermediate Speed 3		ft/min
	Voltage Constant ke			0.LF.50	Start Jerk		ft/s ³
LF.15	Power Factor		-	0.LF.51	Acceleration		ft/s ²
LF.16	Field Weakening Speed		rpm	0.LF.52	Acceleration Jerk		ft/s ³
LF.17	Rated Motor Torque		lb ft	0.LF.53	Deceleration Jerk		ft/s ³
LF.18	Motor Resistance		ohms	0.LF.54	Deceleration		ft/s ²
LF.19	Motor Inductance		mH	0.LF.55	Approach Jerk		ft/s ³
LF.20	Contract Speed		ft/min	1.LF.50	Start Jerk		ft/s ³
LF.21	Traction Sheave Diameter		inches	1.LF.51	Acceleration		ft/s ²
LF.22	Gear Reduction Ratio		-	1.LF.52	Acceleration Jerk		ft/s ³
LF.23	Roping Ratio		-	1.LF.53	Deceleration Jerk		ft/s ³
LF.24	Load		lb	1.LF.54	Deceleration		ft/s ²
LF.27	Encoder Pulse Number		ppr	1.LF.55	Approach Jerk		ft/s ³
LF.28	Swap Encoder Channels		-	2.LF.50	Start Jerk		ft/s ³
LF.29	Sample rate for encoder		mS	2.LF.51	Acceleration		ft/s ²
LF.30	Control Mode		-	2.LF.52	Acceleration Jerk		ft/s ³
A.LF.31	KP Speed (accel)		-	2.LF.53	Deceleration Jerk		ft/s ³
d.LF.31	KP Speed (decel)		-	2.LF.54	Deceleration		ft/s ²
P.LF.31	KP Speed (Synth. Pre-Torque)		-	2.LF.55	Approach Jerk		ft/s ³
A.LF.32	KI Speed (accel)		-	LF.56	Stop Jerk		ft/s ³
d.LF.32	KI Speed (decel)		-	LF.57	Speed Following Error		
P.LF.32	KI Speed (Synth. Pre-Torque)		-	LF.58	Speed Difference		%
A.LF.33	KI Speed Offset (accel)		-	LF.59	Following Error Timer		sec
				LF.61	Emergency Power Mode		-
				LF.67	External Pre-torque Gain		-



Para.	Name	Customer Value	Unit
LF.68	External Pre-torque Offset		%
LF.69	External Pre-torque Direction		-
LF.70	Speed Start Delay		s
LF.71	Brake Release Delay		s
LF.76	Encoder multiplier		-
LF.77	Absolute Encoder Position		-
LF.78	Brake Engage Time		s
LF.79	Current Hold Time		s
LF.80	Software Version		-
LF.81	Software Date		-

LP.1	One Floor Positioning		-
LP.2	Min. Slowdown Dist.		inch
LP.3	Slowdown Distance		inch
LP.4	Correction Distance		inch
LP.21	Scaling Increments High		-
LP.22	Scaling Increments Low		-
LP.23	Scaling Distance		inch

Para.	Name	Customer Value	Unit
Ld.18	Field Weakening Corner		rpm
Ld.19	Field Weakening Curve		-
Ld.20	Stator Resistance		ohms
Ld.21	Sigma Inductance		mH
Ld.22	Rotor Resistance		ohms
Ld.23	Mag. Inductance		mH
Ld.24	Motor Control		-
Ld.25	Vmax Regulation		%
Ld.27	KP Current		-
Ld.28	KI Current		-
Ld.29	Acceleration Torque		Nm
Ld.30	System Inertia		kgcm ²
Ld.31	FFTC Filter		-
Ld.32	FFTC Gain		%
Ld.33	Torque Command Filt.		-

Advanced Parameters

Para.	Name	Customer Value	Unit
US.16	E.OL2 function		-
US.17	Pre - Torque Timer ramp up		sec
US.18	Pre - Torque Timer ramp down		sec
US.20	max speed for max KI		fpm
US.21	speed for min KI		fpm
US.22	Speed Dependent KP Gain		-
US.23	Min KP Gain at High Speed		-
US.24	KD speed gain		-
US.25	Phase Current Check		-
US.26	Encoder Diagnostic		-
US.28	Analog Input Noise Clamp		%
US.29	HSP5 Watchdog Time		mS
US.33	EdOH function		-
US.34	Analog Pattern Gain		-
US.35	Reference Splitting		mSec
US.36	Baud Rate		mSec
US.37	Test Function		-

Digital I/O Handling

Para.	Name	Customer Value	Unit
di.0	Input Type		-
di.3	Noise Filter		mSec
do.42	Digital Output Inversion		-
do.80	Output X2A.18		-
do.81	Output X2A.19		-
do.82	Output X2A.24...26		-
do.83	Output X2A.27...29		-

KEB AMERICA INC.
5100 Valley Industrial Blvd.
Shakopee, MN 55379
Phone: 952-224-1400
www.kebamerica.com

© KEB	
Mat. No.	00.F5.LUB-K172
Rev.	1D
Date	9/2015