



G.A.L. Manufacturing Corporation

50 East 153rd Street,
Bronx, N.Y. 10451

Phone 718-292-9000
Toll Free 877-425-3538
877-425-7763

Fax 718-292-2034
Web www.gal.com
E-mail info@gal.com



MOVFR

ELECTRICAL ADJUSTMENTS

i
COMMENTS

All G.A.L. door operators are factory adjusted and tested for the actual job requirements. When installed correctly, they may require minor adjustments to suit actual job conditions.

IMPORTANT:

All equipment must be installed, adjusted, tested and maintained to comply with all Federal, State, and Local codes.

See section 7.6, page 28 in this manual for Kinetic Energy and closing force requirements.

Before mounting the operator, check that the car door is plumb, free and moves easily without bind. Check the attached standard measurements sheets. Install the operator according to the measurements supplied.

ii
FOREWORD

It is the intent of this manual to give the reader certain key points of information critical to the proper installation of the door operator. It is not intended to give comprehensive installation procedures nor does it cover the installation of door headers, tracks, hangers, etc.

It is hoped that the procedures presented in this manual will reduce the installation and adjustment time and result in a smooth, long lasting door operation.

When properly installed, G.A.L. operators will give many years of trouble free service.

iii
TABLE OF CONTENTS

SECTION	PAGE
i	Comments.....2
ii	Foreword.....3
iii	Table of Contents.....4

ELECTRICAL SECTION:

7.1- Overview.....	5
7.2- Adjustment aids.....	5
7.3- Preliminary Checks.....	8
7.4- The parameter unit.....	9
7.5- Parameter unit navigation.....	9
7.6- Parameter adjustments.....	13
7.7- Speed profiles of the MOVFR.....	16
7.8- Cam setting versus distance.....	17
7.9- Rotational cam setting.....	18
7.10- Interfacing between G.A.L. certified light curtain and the MOVFR.....	19
7.11- MOVFR connection diagram.....	21
7.12- Fault description and Fault reset.....	22
7.13- Applications for the heavy input.....	24
7.14- Parameters list.....	28
7.15- How to replace the drive.....	35

ELECTRICAL ADJUSTMENTS

ADJUSTING INSTRUCTIONS FOR THE G.A.L. VARIABLE FREQUENCY CLOSED LOOP DOOR OPERATOR TYPE MOVFR

7.1 Overview:

The MOVFR is a 230VAC door operator. It is controlled by a variable voltage, variable frequency (VVVF) closed loop drive. The control includes an AC ½ HP Motor, a VVVF Drive, and a PC board. It features keypad programming with digital display, door position optical cams, sequential Light Emitting Diodes (LED) for door speed positions, obstruction detection signal, and DPM Fault Monitor* signal. A Heavy Door Input, and an Auxiliary Cam are also available, when needed. MOVFR accepts universal input control signals from dry contacts to signal voltages, from 24 to 230V AC or DC**. The output contacts rated at 10Amp, 230VAC, and they are: Door Close Limit (DCL), Door Open Limit (DOL), Re-Open (REOPEN), Door Protection Monitor (DPM), and Auxiliary (AUX).

*: The Fault Monitor is a G.A.L. patented door lock and gate switch protection device. Its purpose is to meet the ASME A17.1 RULE 210.15 and CAN/CSA-B44-M90 RULE 3.12.1.5.

** : If the input signal voltage is 60 volts or less, the input board resistor must be cut (see connection diagram Dwg. No. 8032).

7.2 Adjustment aids:

Switches, LED pilot lights and a Parameter Unit are available to aid the adjustment of the operator (see Figure 7.2.A).

A. Five toggle switches are provided to facilitate the adjusting procedure as describe below:

1. RUN/CAM SETUP switch. The RUN position is for normal operation. The CAM SETUP position allows adjusting the cams and turning on the appropriate pilot lights without applying power to the motor.
2. AUTO/MAN. switch. The AUTO position is for normal operation. The MAN. position allows opening and closing the door by means of the OPEN/CLOSE switch.
3. OPEN/CLOSE switch allows constant pressure opening and closing when the AUTO/MAN. switch is in the MAN. position.
4. NUDG. switch allows closing the door at a reduced speed (nudging speed) when the AUTO/MAN. is in the MAN. position and constant pressure is applied to CLOSE position and NUDG position of the OPEN/CLOSE and NUDG switches respectively.
5. HEAVY/RESET switch. When the AUTO/MAN. switch is in the MAN. position, if a constant pressure is applied to the HEAVY position, it will work in conjunction with OPEN/CLOSE, NUDG. switches to open, close, or nudge the door. The RESET position allows manual reset of faults of the drive. On the drive, the Green LED indicates drive has power, the Red LED indicates an alarm has occurred and shutdown the drive. If this occurs, make a visual inspection of the door, and if there are no visible problems, place the AUTO/MAN. switch in the MAN. position, apply pressure to the RESET position of the HEAVY/RESET switch then release. Operate the door with the OPEN/CLOSE switch.

Making sure that all is clear before returning to AUTO mode. Use the Parameter unit to view the Alarm history.

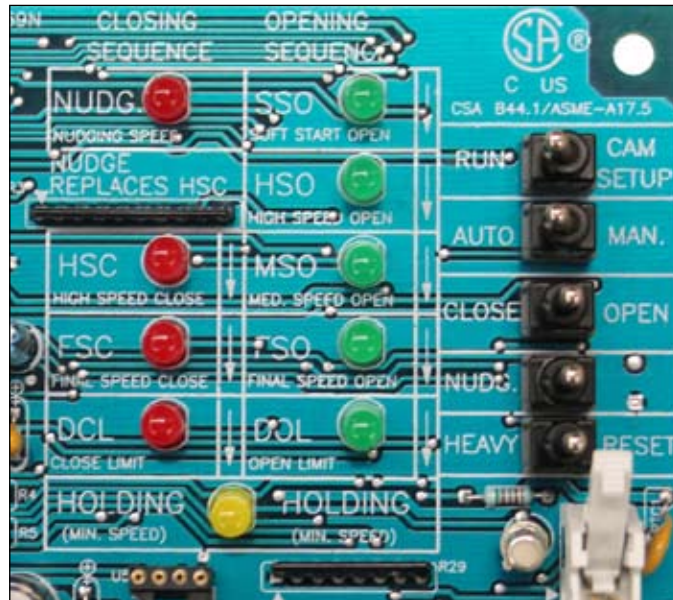

FIGURE 7.2.A

B. LED pilot lights:

A Red LED is provided on each of the four input boards (open, close, nudg., heavy). Heavy input is optional. As mentioned earlier, the input board resistor must be cut if the inputs signal voltage is 60 volts or less (see Figure 7.2.B.1).

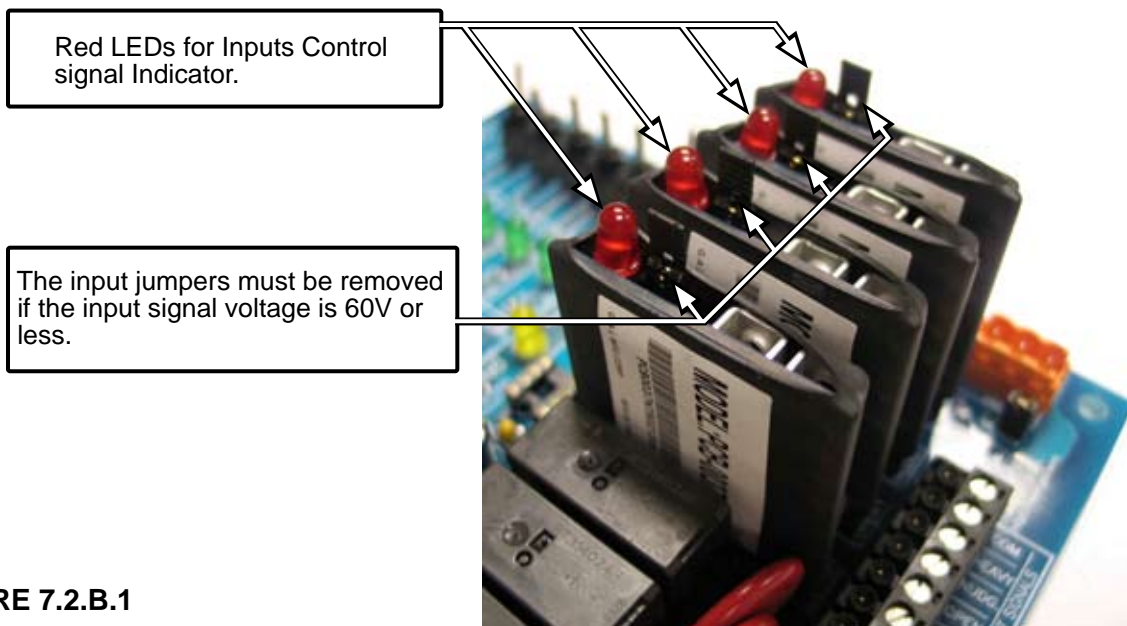

FIGURE 7.2.B.1

There are 16 more LED lights are provided to indicate the position of the speed cams, limit cams and modes of operation. When a cam blocks an optical sensor, the function is activated and the corresponding LED light turns on (see Figure 7.2.B.2). The 16 LED lights are:

1. HSC: High Speed Close.
2. FSC: Final Speed Close.
3. DCL: Door Close Limit (DCL output relay is energized when the DCL LED light turns on).
4. SSO: Slow Start Open.
5. HSO: High Speed Open.
6. MSO: Medium Speed Open.
7. FSO: Final Speed Open.

Note: The combination of Cam#1(SSO/FSO) and Cam#2(MSO) produces SSO, HSO, MSO, and FSO. See 7.7 CAM SETTINGS VS. DISTANCE for appropriate settings.

8. DOL: Door Open Limit (DOL output relay is energized when the DOL LED light turns on).
9. HOLDING: Door is in its full open or full close position. (When the door is fully open or fully closed, a minimal amount of power is applied to the motor to prevent drifting).
10. NUDG. Door is closing at reduced speed (nudging).
11. RE-OPEN: Door re-opening features have activated. (RE-OPEN output relay is energized when the RE-OPEN LED light turns on).
12. STALL REVERSE: In the close direction, if the door exceeds the Torque Limit set by Par. 9, the STALL REVERSE LED will turn on and the RE-OPEN relay will be energized).
13. FREQ. FAILURE: In the close direction, if the door exceeds the Speed Limit set by Par. 0, the FREQ. FAILURE LED will turn on and the RE-OPEN relay will be energized).
14. DPM: A car door closed contact for safety features such as G.A.L. Fault monitor. (DPM relay is energized when the DPM LED light turns on).
15. FAULT: The FAULT LED on indicates that there is a Fault in the drive.
16. AUX.: The AUX. LED and the AUX. relay will turn on when AUX cam is activated. AUX. cam and AUX. cam are optional and available upon request.

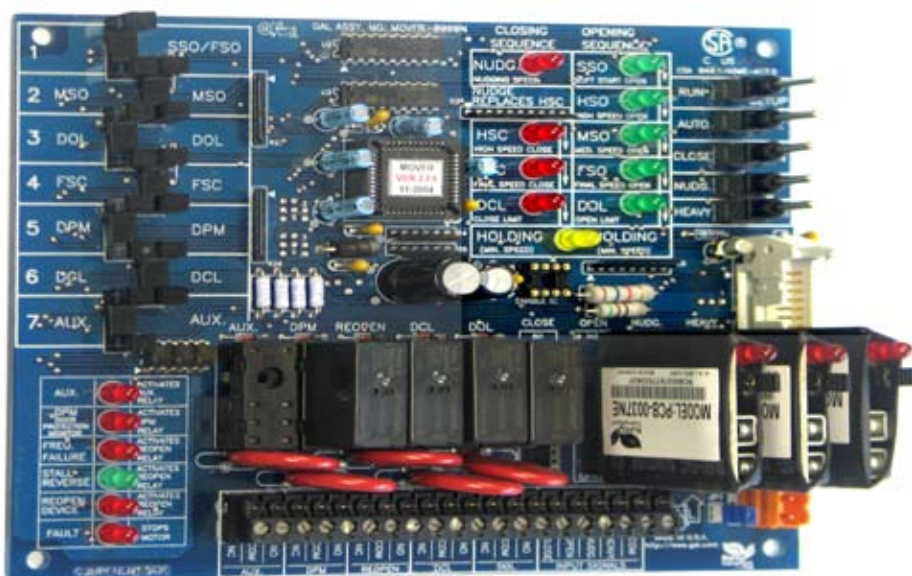

FIGURE 7.2.B.2

C. Parameter unit:

The Parameter unit plugs into the drive and permits changing values of pertinent parameters (see Figure 7.4).

7.3 Preliminary checks:

This procedure is to assure that the motor turns in the correct direction, and all speed signals are in the working order.

- A.** Place the RUN/CAM SETUP switch in the RUN position and place the AUTO/MAN switch in the MAN. Position.
- B.** With the door fully closed, hold the OPEN/CLOSE switch in the OPEN position while observing the door movement. If the motor turns in the wrong direction, turn Power OFF, swap any two of the three motor leads. The door should change speed as the various cams operate the speed controlling speed sensors.

The door should start moving at low speed with the SSO sensor blocked and then accelerate to high Speed (HSO) as the SSO sensor is unblocked. Deceleration takes place when the MSO sensor is blocked, then more deceleration with the FSO sensor is blocked, and finally the DOL sensor is blocked and the HOLDING LED turns on. A little power will apply to the motor to hold doors open.

When the door is fully open, hold the switch in the CLOSE position, the door should start accelerating To high speed (HSC) and then decelerating as the FSC sensor is blocked. Finally the DCL sensor is blocked and the HOLDING LED turns on. Again, a little power will apply to the motor to hold doors open. (See 7.7 CAM SETTING VS. DISTANCE).

7.4 The parameter unit:

The Parameter unit is a tool to assist users in the following tasks:

- Changing speed values, acceleration, deceleration, torque, maximum closing speed, carrier frequency, and stall reverse limit.
- Downloading, and Uploading Programs to and from the Drives.
- Monitoring Currents, Voltages, Speeds, Inputs, Outputs, and Faults.
- Resetting the Drive.



FIGURE 7.4

7.5 Parameter unit navigation:

A. How to change parameters:

Press **SET** . Enter a Parameter Number.

Press **READ** . Enter a new Value. Press **WRITE** .

Wait for the Completed Signal from the Display.

B. How to read (COPY) from the drive:

Note 1 : The Parameter Unit is capable to store 4 Sets of Default Parameters and 1 Set of Working Parameters. To Copy a Default Set of Parameters into the Working Set Parameters, see item 8th of Section F.

Note 2 : To Transfer data from one drive to another, users must, First, READ(COPY) from the First Drive.

Press **SET** . Press **▲** .

Press **READ** . Wait for the Completed Signal from the Display.

C. How to write (DOWNLOAD) to the drive:

Set RUN/CAM setup switch to CAM setup.

Press **SET** . Press **▲** .

Press **WRITE** . Wait for the Completed Signal from the Display.

D. Default settings for the MOVFR drive:

CLOSING	PARAMETER #		RANGE	DEFAULT VALUE							
				STANDARD				WATERPROOF			
				C/P		S/O		C/P		S/O	
	REG.	HVY.		REG.	HVY.	REG.	HVY.	REG.	HVY.	REG.	HVY.
MAX. CLOSE SPEED	0	0	0-30	30	30	30	30	30	30	30	30
HOLDING TORQUE	1	11	0-30	5	5	5	5	5	5	5	5
HOLDING SPEED	2	12	0-400	2	2	2	2	1.5	1.5	1.5	1.5
CLOSE TORQUE ■	3	13	0-400	225	225	173	173	173	173	135	135
HIGH SPEED HSC	4	14	0-400	23	12	19	10	14	7	12	6
FINAL SPEED FSC	5	15	0-400	4	4	5	5	3	3	4	4
NUDGING SPD	6	16	0-400	8	8	9	9	5	5	6	6
ACCELERATION TIME	7	17	0-320	9	9	6	6	7	7	10	10
DECELERATION TIME	8	18	0-320	6	6	10	10	17	17	25	25
STALL REV. FORCE	9	19	0-2	1.6	1.6	1.6	1.6	1.6	1.6	1.6	1.6
OVERLOAD	99	99	0-5	3	3	3	3	3	3	3	3

OPENING	PARAMETER #		RANGE	DEFAULT VALUE							
				STANDARD				WATERPROOF			
				C/P		S/O		C/P		S/O	
	REG.	HVY.		REG.	HVY.	REG.	HVY.	REG.	HVY.	REG.	HVY.
QUICK STOP ON REV.	21	31	0-6	0.8	1.0	1.4	1.6	0.8	1.0	1.4	1.6
SLOW START SSO	22	32	0-400	5	5	5	5	5	5	5	5
HIGH SPEED HSO	23	33	0-400	31	16	45	23	24	12	35	18
MEDIUM SPEED MSO	24	34	0-400	14	14	20	20	10	10	15	15
FINAL SPEED FSO	25	35	0-400	3	3	5	5	2	2	3	3
ACCELERATION TIME	26	36	0-320	6	6	4	4	6	6	6	6
DECELERATION TIME	27	37	0-320	6	6	10	10	9	9	10	10
SLOW SPD TORQUE	28	38	0-30	4	4	4	4	4	4	4	4
OPEN TORQUE ■	29	39	0-400	120	100	120	100	100	80	100	80

■ To lower torque, increase the torque parameter value

OPENING AND CLOSING	PARAMETER #	RANGE	DEFAULT VALUE			
			STANDARD		WATERPROOF	
			C/P	S/O	C/P	S/O
CARRIER FREQUENCY	51	2-15	10	10	10	10

C/P = Center Parting Door
 REG. = Regular Doors

S/O = Side Opening Door
 HVY. = Heavy Doors

E. Convenient keys:

Press  to check the Speed in Hz

Example:

Output	Frequency
HSC	19Hz

Press  to check Input & Output Signals.

Inputs:**Z:** (Reserved)**C:** Door Close**O:** Door Open**R:** Reset**V:** Heavy Door**L:** Control Bit L**M:** Control Bit M**H:** Control Bit H**Outputs:****S:** Over Speed**T:** Over Torque**F:** Fault

Example:

ZCORVLMH	STF
010001000000	

Press  to check the recent Faults.

Press  or  to view all the Faults

Example:

Present	Fault
Under	Voltage

Press  to check the Output Voltage.

Example:

Output	Voltage
	132.00V

Press  to check the Output Current.



Example:

Output	Current
	0.78A

Press  to Reset the Drive.

F. The  keys:

Press the  key will allow users to view, change, and reset to G.A.L. Default parameters.

Press  or  to navigate through all the items in the VIEW section.

Press  to view an item. At any time, Press  to get back to the Previous Display.

1st. **V/I/H** Displays the Output Voltage, Output Current, Command Speed, and Actual Speed.

2nd. **I/O** Displays the Input and Output Signals

ZCORVLMH STF 1= Activate 0= Deactivate
(See the **Convenient keys** in part E)

3rd. **Faults.** (See the **Convenient keys** in part E)

Press  or  to View all the Faults.

4th. **Counters.** There are 2 Counters.

Counter 1 will count up to 9,999 times.

Counter 2 will count up to 60,000 times.

When Counter 1 reaches 9999, Counter 2 will increase 1

The total count will be 600,000,000 times.

Press  or  to View Counter 1 or Counter 2.

5th. **User List.**

The User List includes all the **Default settings for the MOVFR drive** in part D.

Press , Press  or  to view all the Parameters in the User List'

NOTE: Users can also change the Value of Parameters in this stage by doing the following:

Press , Enter the new value, then Press .

Press  to get back to the Previous Display.

6th. **Max. cl. Speed**

Press  to view the Maximum Closing Speed.



Press  to get back to the Previous Display.

7th. **Max. cl. Force**

Press  to view the Maximum Closing Force.

Press  to get back to the Previous Display.

8th. **GAL Defaults**

Press , Press  or  to pick one of the four sets of Parameters

Standard C/P

Standard S/O

Waterproof C/P

Waterproof S/O

Set RUN/CAM SETUP switch to CAM SETUP

Press  to copy the chosen set of Parameters to the Working Set of Parameters.

G. LED indicators:

There are 7 LEDs on the Parameter Unit. DO, DC, NUD, HLD, PRG, FLT, OVT. DO=Door Open, DC=Door Close, NUD=Nudging, HLD=Holding, PRG=Programming Mode, FLT=Fault, OVT=Over Torque. These LEDs indicate the present status of the MOVFR.

7.6 Parameter adjustments:

CAUTION! All equipment must be installed and adjusted to meet Federal, State, and Local Codes.

NOTE 1: The closing Kinetic Energy is affected by the speed and the mass of the door. The closing Kinetic Energy must not exceed Code Limits. For more details about the Kinetic Energy of the G.A.L door operators, go to <http://www.gal.com>

NOTE 2: The closing Torque is affected by the Torque adjustment. The closing Torque must not exceed Code Limits.

NOTE 3: Whenever changing any value in the Closing Direction Parameters, the door should be rechecked to meet the Code requirement.

A. Closing sequence:**MAXIMUM CLOSE SPEED (Par. 0):**

This Parameter is the Limit of the Closing speed. The Default value of this Parameter is 30Hz. If the Closing speed is higher than 30Hz, the Drive will turn on the Frequency Failure (FF) output and activate the Reopen Relay. Users should bear in mind that the Reopen Relay Contact, once activated, will send the re-open signal to the Main Controller ONLY and will wait for the OPEN signal from the Main Controller to Reopen the door. The Reopen Relay will NOT reopen the door by itself.

HOLDING TORQUE (Par. 1):

The Holding Torque is activated when the door reaches DOL or DCL.

HOLDING SPEED (Par. 2):

The Holding Speed is activated when the door reaches DOL or DCL.

NOTE: The reason to apply the Holding Power when the door is fully closed or fully open is to prevent the door from drifting or rolling back.

CAUTION! The Holding power should be less than 15W to prevent the motor from unnecessary heating, which would reduce its life.

HIGH SPEED CLOSE – HSC (Par. 4):

This is the highest speed for the overall Closing sequence. A higher value produces the faster speed.

FINAL SPEED CLOSE – FSC (Par. 5):

This is the Final Closing Speed. It should be set reasonably low so that when the DCL (Door Close Limit) and the Close Stop Roller are reached without slamming or bouncing.

NUDGING SPEED (Par. 6):

The Nudging Speed is the reduced speed that is equal or less than 60% of the max. HSC. This Nudging Speed is only occurred when DC (Door Close) and NUDG. (Nudging) input signals take place simultaneously

CLOSE ACCELERATION TIME (Par. 7):

The higher value produces a slower acceleration rate for smoother operation. The lower value produces a faster acceleration rate for faster opening times.

CLOSE DECELERATION TIME (Par. 8):

The Deceleration should be set so that the FSC is reached prior to the DCL and the Close Stop Roller position without bouncing.

STALL REVERSE FORCE (Par. 9):

The Default value of this Parameter is 1.5Amp. Whenever the current is above this value, the Drive will send a signal to turn on the STALL REVERSE LED and activate the REOPEN Relay. The range for this Parameter is 0-2Amp. If nuisance activation takes place, the value of this Parameter should be increase slightly.

OVERLOAD (Par. 99)

This is the Maximum Limit of the Motor Current. If the Motor Current exceeds this Limit, the Drive will shutdown, generate the OVER CURRENT FAULT, and turn on the FAULT LED. Recycling the Power to MOVFR or using the Reset switch on the Main Board or the Parameter Unit will Reset the Fault. However, a thorough inspection should be done before Resetting the Fault.

B. Opening Sequence:**QUICK STOP ON REVERSE (Par. 21):**

Parameter 21 determines how quick the closing door is stopped when a reopen signal is activated. The range of Parameter 21 is from 0 to 6Amp. The lower value setting will produce a longer time to stop before the door can reopen. When the reopen signal is applied, the door should not move more than 2 inches before it reopens. (Note: too quick of a stop will degrade the doors mechanicals)

SLOW START OPEN – SSO (Par. 22):

When the door starts to open, the value of Par. 22 is the speed at which the clutch engages the interlock rollers unlock the hoistway door. A slower speed produces a smoother and quieter unlocking noise.

HIGH SPEED OPEN – HSO (Par. 23):

This is the highest speed for the overall opening sequence. The higher value produces a faster speed.

MEDIUM SPEED OPEN – MSO (Par. 24):

This speed is used for a fast reopening in the final 1/3 to 1/4 of the opening. When properly adjusted, this speed has little or no effect during the full reopening cycle because the doors will decelerate through MSO zone. Virtually the doors will decelerate from HSO to FSO.

FINAL SPEED OPEN – FSO (Par. 25)

This is the Final Opening Speed. It should be set reasonably low so that the DOL (Door Open Limit) and the Open Stop Roller are reached without slamming or bouncing.

OPEN ACCELERATION TIME (Par. 26).

The higher value produces a slower acceleration rate for smoother operation. The lower value produces a faster acceleration rate for faster opening times.

OPEN DECELERATION TIME (Par. 27).

The Deceleration should be set so that the FSC is reached prior to the DCL and the Close Stop Roller position without bouncing.

SLOW SPEED TORQUE (Par. 28).

This Parameter is set at 0 as a default value. The range of this Parameter is from 0 to 30%. It is a torque boost Parameter at low speed. It is a useful Parameter for the heavy doors, if needed.

OPEN TORQUE (Par. 29)

The Default value of this Parameter should be suitable for most doors. Nevertheless, the rule for adjustment for this Parameter is: The higher value will produce less torque, and vice versa.

C. Carrier frequency:**CARRIER FREQUENCY (Par. 51)**

The nominal frequency of the carrier wave is set by Parameter 51. The Default value is 10KHz. The MOVFR Drive is compliant with the CE regulation. However, if adjacent electronics, with poor EMI immunity, are affected by EMI of the MOVFR, users can lower the value of this Parameter to reduce the EMI level. The trade-off is the lower carrier frequency; the more audible noise will be produced by the motor.

7.7 Speed profiles of the MOVFR:

A. Closing Cycle:

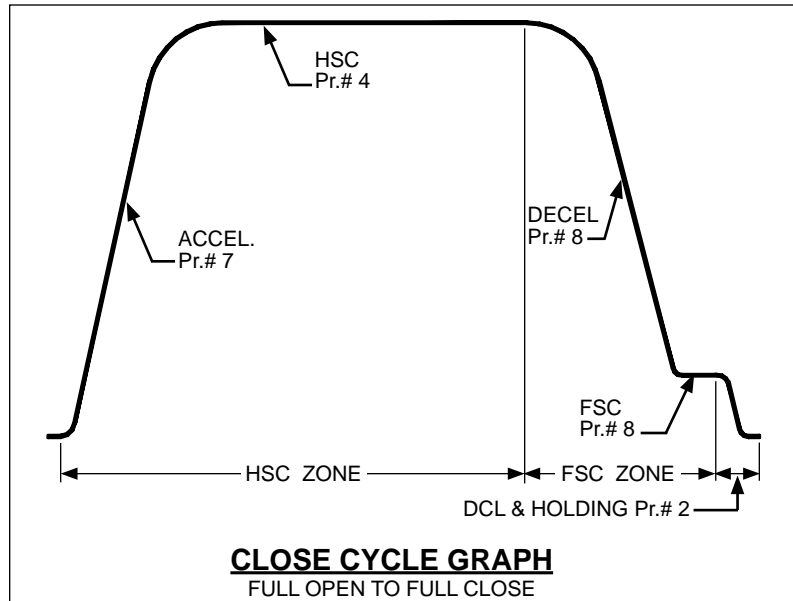



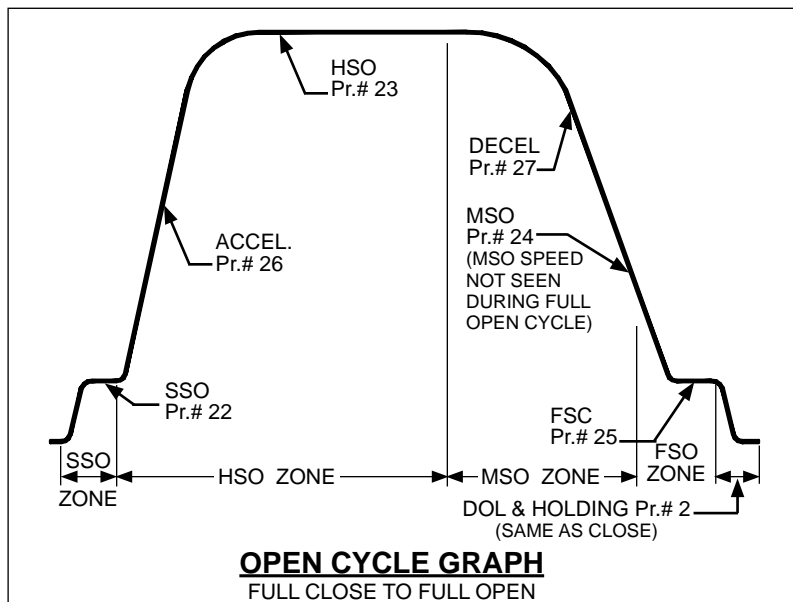



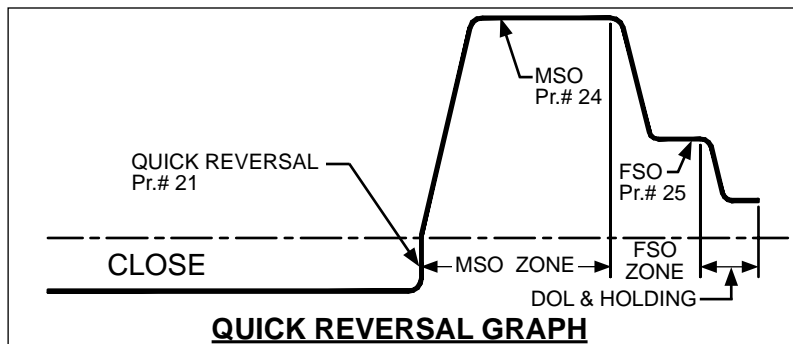





B. Opening Cycle:



















C. Quick Reversal:



7.8 Cam setting versus Distance:

CLOSING DIRECTION				
←				
SPEED	DCL	DPM	FSC	HSC
DISTANCE	Last 1/4 inch	1/2 inch before Gate Switch is activated	Last 4 inches	Until the door reaches 4 inches from the final close
CAM 4 FSC				
CAM 5 DPM				
CAM 6 DCL				

OPENING DIRECTION						
→						
SPEED	SSO	HSO		MSO	FSO	DOL
DISTANCE	Until the clutch makes up (first 1/2 inch)	From the clutch made up (approx. 1/2) in to 3/4 of the total door width		Last 1/4 of the total door width	Last 4 inches	Last 1/4 inch
CAM 1 SSO/FSO						
CAM 2 MSO						
CAM 3 DOL						

CONVENIENT CAM		
←		
ACTION	ACTIVATE AUX. RELAY	DEACTIVATE AUX. RELAY
DISTANCE	Customer Setup	Customer Setup
CAM 7 AUX.		

 = CAM BLOCKED

 = CAM UNBLOCKED

7.9 Rotational cam setting:

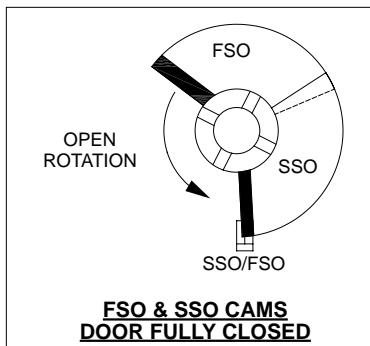
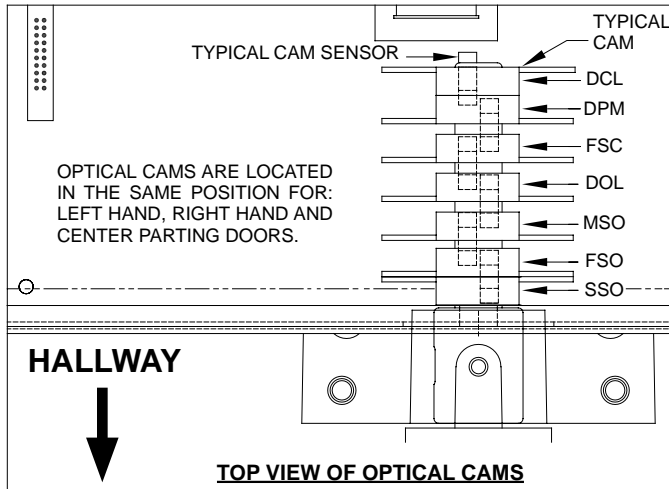

RIGHT HAND CAMS

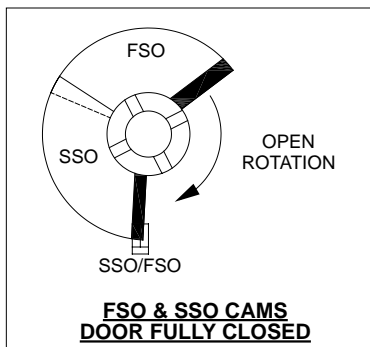
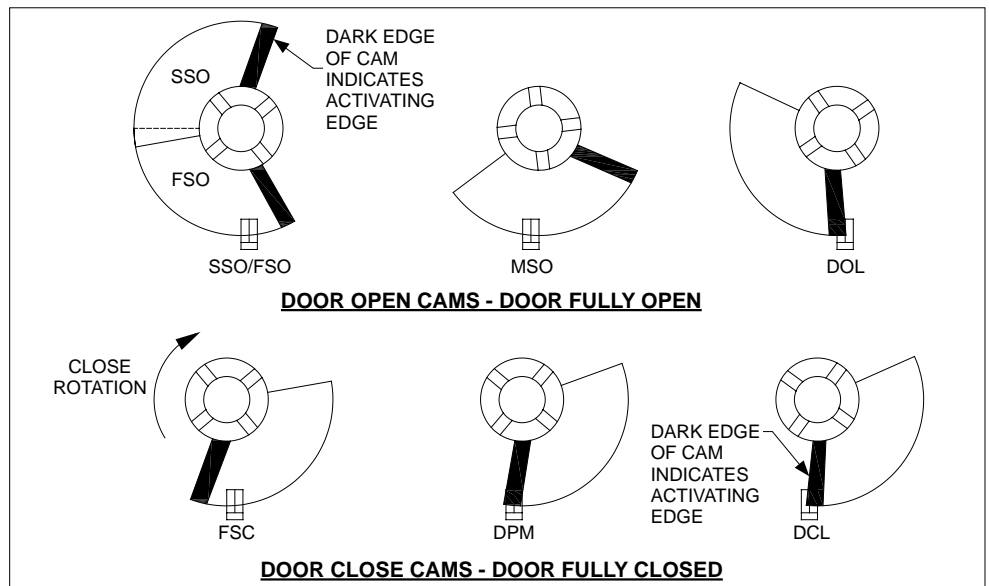

**LEFT HAND
AND
CENTER PARTING
CAMS**

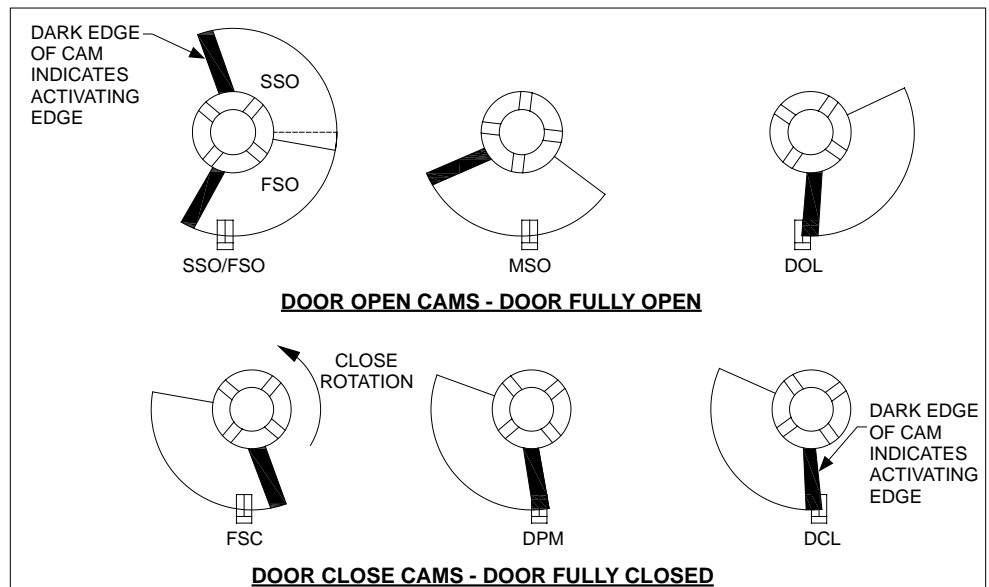

7.10 Interfacing between G.A.L. certified light curtain and MOVFR:

A. Procedure:

To take full advantage of the MOVFR and simplify the REOPENING circuits for the Door Operators, the REOPEN relay in the MOVFR board should be used to Reopen the doors in cases of:

- Exceeding the limit of the torque allowed.
- Exceeding the limit of the speed allowed.
- Obstructing the light curtain.

The exceeding Torque and exceeding Speed features have already been built in the MOVFR board. Additionally, for the obstruction of the Infrared Light Curtains, the following illustration shows the interfacing procedure of a **G.A.L. Certified Infra-Red Light Curtain** and the **G.A.L. MOVFR** board.

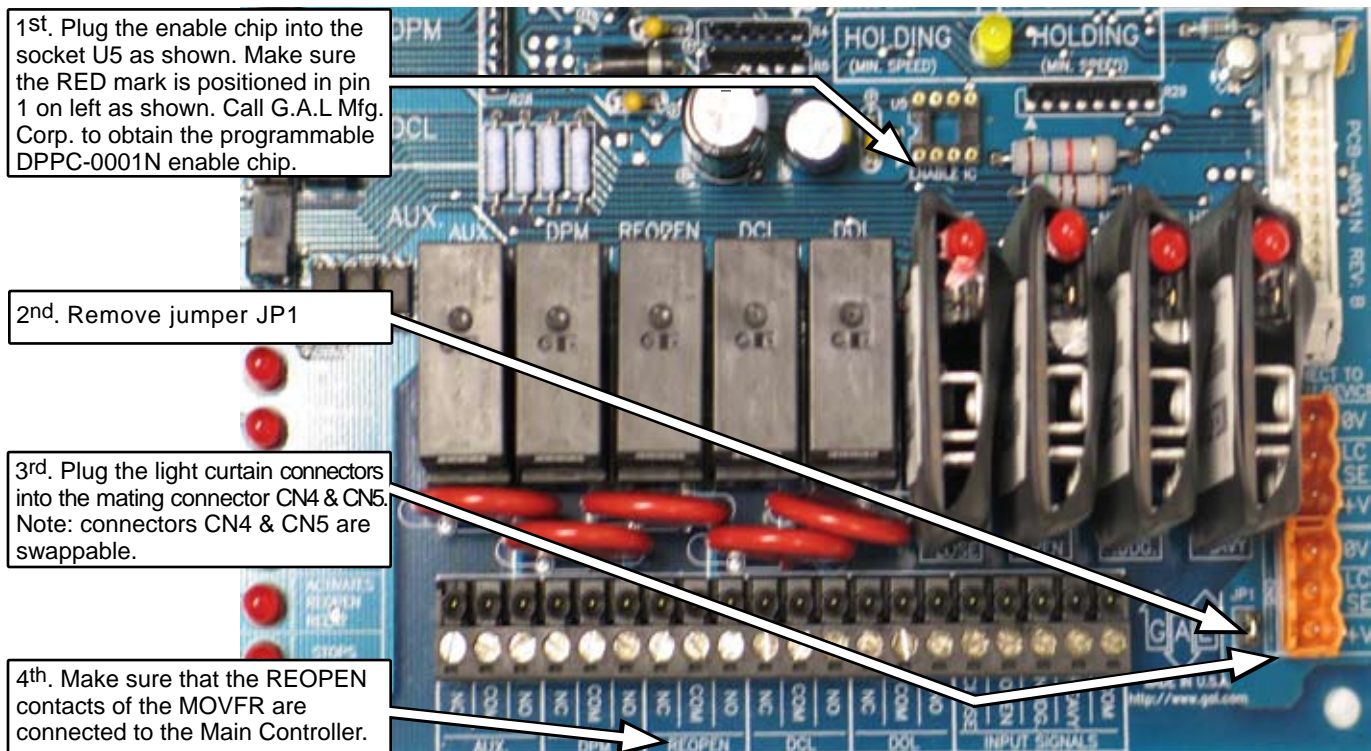

Followings are the G.A.L. Certified Infrared Light Curtain Detectors, in alphabetical order, that are available from G.A.L Mfg. Corp (<http://www.gal.com>).

Toll Free Phone: **1-877-425-3538 (877-GAL-ELEV)**

- Formula Systems
- Tri-Tronics

B. Operation:

When obstruction on the edges occurs, the reopen LED on the MOVFR will turn on and the reopen relay will be activated. The reopen contacts will send reopen signal to the main controller and wait for the DO (Door Open) Signal from the Main Controller to Reopen the door.

C. Wiring diagram:

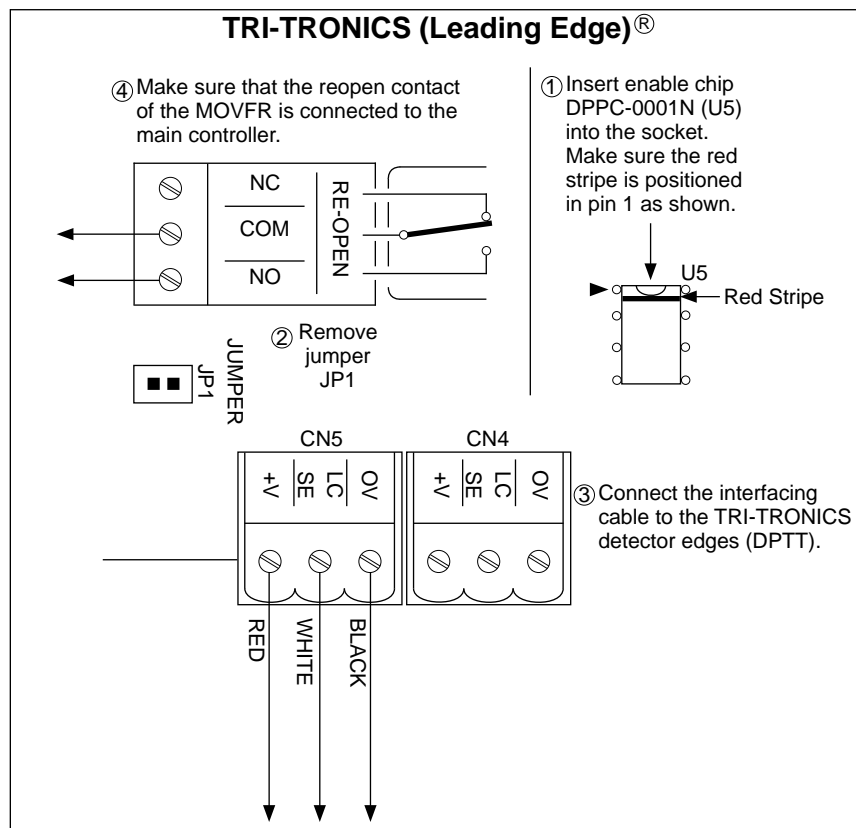
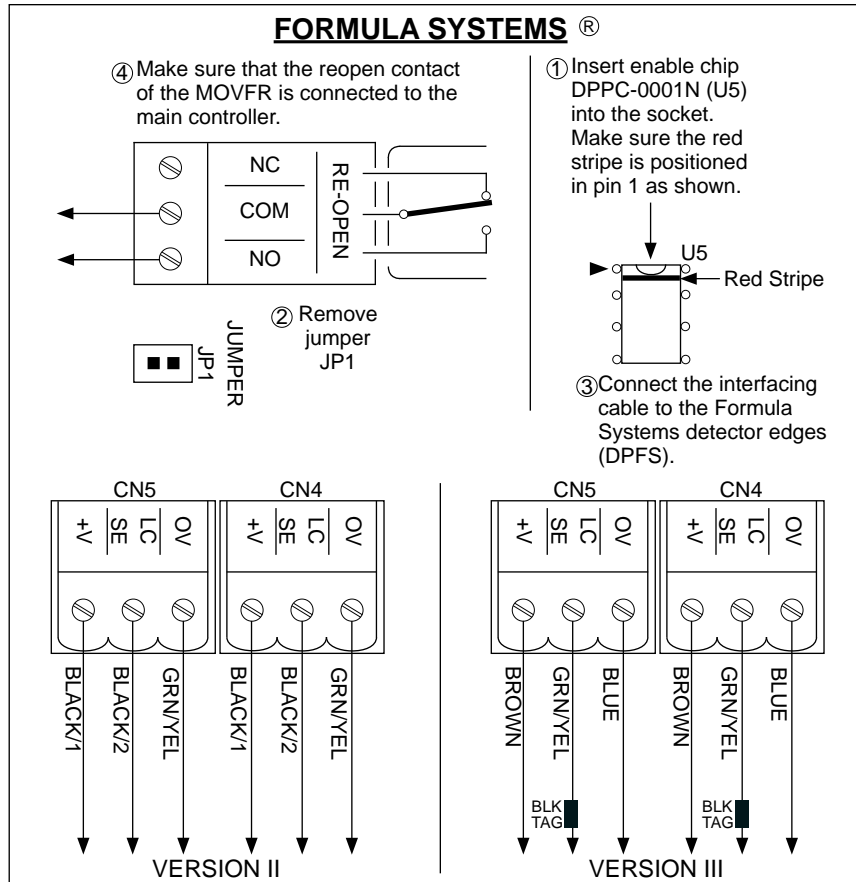

7.11 MOVFR connection diagram:

INSTRUCTIONS FOR THE G.A.L. PARAMETER UNIT

CAUTION: To Transfer data from one Drive to another, user must READ (COPY) from the first Drive.

HOW TO READ (COPY) FROM THE DRIVE: Press SET, Press Up Arrow, Press READ, Wait for the Completed Signal from the Display.

HOW TO WRITE (DOWNLOAD) TO THE DRIVE: Press SET, Press Up Arrow, Press WRITE, Wait for the Completed Signal from the Display.

HOW TO CHANGE PARAMETERS: Press SET, Enter Par. number, Press READ, Enter a new Value, Press WRITE, Wait for the Completed Signal from the Display.

CLOSING	PARAMETER#		RANGE	DEFAULT VALUE								OPENING	PARAMETER#		RANGE	DEFAULT VALUE							
	REG.	HVY.		STANDARD				WATERPROOF					REG.	HVY.		STANDARD				WATERPROOF			
				C/P	S/O	C/P	S/O	C/P	S/O	C/P	S/O					C/P	S/O	C/P	S/O				
MAX. CLOSE SPEED	0	0	0-30	30	30	30	30	30	30	30	30	30	30	0-6	0.8	1.0	1.4	1.6	0.8	1.0	1.4	1.6	
HOLDING TORQUE	1	11	0-30	3	3	3	3	3	3	3	3	3	3	0-400	5	5	5	5	5	5	5	5	
HOLDING SPEED	2	12	0-400	2	2	2	2	1.5	1.5	1.5	1.5	1.5	1.5	0-400	31	16	45	23	24	12	35	18	
CLOSE TORQUE	3	13	0-400	225	225	173	173	173	173	135	135	135	135	0-400	14	14	20	20	10	10	15	15	
HIGH SPEED HSC	4	14	0-400	23	12	19	10	14	7	12	6	6	6	0-400	3	3	5	5	2	2	3	3	
FINAL SPEED FSC	5	15	0-400	4	4	5	5	3	3	4	4	4	4	0-320	6	6	4	4	6	6	6	6	
NUDGING SPD	6	16	0-400	8	8	9	9	5	5	6	6	6	6	0-320	6	6	10	10	9	9	10	10	
ACCELERATION TIME	7	17	0-320	9	9	6	6	7	7	10	10	10	10	0-320	4	4	4	4	4	4	4	4	
DECELERATION TIME	8	18	0-320	6	6	10	10	17	17	25	25	25	25	0-320	6	6	10	10	9	9	10	10	
STALL REV. FORCE	9	19	0-2	1.6	1.6	1.6	1.6	1.6	1.6	1.6	1.6	1.6	1.6	0-320	4	4	4	4	4	4	4	4	
OVERLOAD	99	99	0-5	3	3	3	3	3	3	3	3	3	3	0-400	120	100	120	100	100	80	100	80	

OPENING AND CLOSING	PARAMETER#		RANGE	DEFAULT VALUE			
	REG.	HVY.		STANDARD		WATERPROOF	
				C/P	S/O	C/P	S/O
CARRIER FREQUENCY	51	51	2-15	10	10	10	10

CONNECT TO GAL. PARAMETER UNIT

C/P = CENTER PARTING DOOR | REG. = REGULAR DOOR
 S/O = SIDE OPENING DOOR | HVY. = HEAVY DOOR
 ■ TO LOWER TORQUE, INCREASE TORQUE PARAMETER VALUE

ALL TERMINALS ARE PLUGGABLE (SEE NOTE 1)

TO CONTROLLER (RELAY CONTACTS ARE RATED AT 10 AMP, 250 VAC)

TO EARTH GROUND (SEE WARNING)

GATE SW. TO MOTOR

U5: THIS ENABLE CHIP (U5) IS NEEDED WHEN USED WITH G.A.L. CERTIFIED INFRARED LIGHT DETECTOR EDGES. (SEE NOTE 2)

CONNECTION METHODS

METHOD 1: CONNECT TO ANY VOLTAGE SOURCE FROM 24-230 VOLTS AC OR DC, 30mA MIN. (OPTIONAL)

METHOD 2: CONTROLLER RELAYS MUST HAVE THE SAME COMMON AND RELAY COIL VOLTAGE MUST BE FROM 24V TO 230V AC OR DC.

NOTES:

1-HEAVY LINES REPRESENT CONNECTIONS FROM ELEVATOR CONTROLLER TO DOOR OPERATOR PC BOARD.

2-MAKE SURE THAT THE ENABLE CHIP U5 IS INSERTED INTO THE SOCKET AS SHOWN.

WARNING: ALL EQUIPMENT MUST BE INSTALLED AND ADJUSTED TO MEET FEDERAL, STATE, AND LOCAL CODES. TO PREVENT AN ELECTRICAL SHOCK, THE FLEXIBLE METALLIC CONDUIT MUST BE FASTENED FIRMLY TO THE MOTOR AND THE CONTROL BOX. THE CONTROL BOX MUST BE GROUNDED.

INFRARED LIGHT CURTAIN CONNECTIONS

TYPE	MFG.	TX (CN5)			RX (CN4)			CONNECTION BETWEEN TX & RX
		+V	LC SE	0V	+V	LC SE	0V	
DPFS	FORMULA SYSTEMS	BLU 1	BRN 2	GRN & YEL	BLU 1	BRN 2	GRN & YEL	NONE
		BRN	GRN & YEL	BLU	BRN	GRN & YEL	BLU	
		RED	BLU	ORG			ORG	
DPJE	JANUS	RED	BLU	ORG			ORG	TX - WHT TO RX - WHT
DPTT	TRI TRONICS	RED	WHT	BLK				NONE

DRIVE OVERLOAD FACTORY SET AT 2.5 A

SUITABLE FOR USE ON A CIRCUIT CAPABLE OF DELIVERING NOT MORE THAN 5000 RMS SYMMETRICAL AMPERES 230 VOLTS MAXIMUM

RECOMMENDED FUSE SIZES

200/230 VAC IF 230VAC DRIVE IS USED & 500 VA MIN.

100/115 VAC IF 115VAC DRIVE IS USED & 500 VA MIN.

4 AMP SLOW BLOW FUSES FOR 230VAC DRIVE (8 AMP MAX.)

8 AMP SLOW BLOW FUSES FOR 115VAC DRIVE (12 AMP MAX.)

8 AMP MAX SLOW BLOW FUSE

OFF

230VAC LINE

EGND

GS

GS1

U

V

W

1/2 HP 3 PHASE MTRS

EGND

TO EARTH GROUND SEE WARNING

EGND

GATE SW. TO MOTOR

INPUT SIGNALS

CLOSE

OPEN

NUDG.

HEAVY

COM

JUMPER

REMOVE THIS RESISTOR IF THE INPUT SIGNAL VOLTAGE IS 60V OR LESS

DOOR CLOSE INPUT INDICATOR

DOOR OPEN INPUT INDICATOR

NUDGING INPUT INDICATOR

HEAVY DOOR INPUT INDICATOR

HEAVY DOOR INPUT IS OPTIONAL AND AVAILABLE UPON REQUEST. WHEN HEAVY INPUT IS ACTIVATED, A DIFFERENT PARAMETER SET IS USED FOR OPEN, CLOSE, AND NUDGING.

CN5

CN4

CONNECT TO G.A.L. CERTIFIED LIGHT DETECTOR EDGES

DATE 1-24-05

REV M

DOC. No. 8032

12/09

7.12 Fault description and Fault reset:**F01 HW Over Current**

The AC drive detects an abnormal increase in current. The maximum allowable hardware current is 300% (9A). When the drive output has exceeded this limit, the "F01" fault code will display on the parameter unit display.

F02 Over Voltage

The AC drive detects that the DC bus voltage has exceeded its maximum allowable value, 400V. When the DC bus voltage has exceeded this value, the "F02" fault code will display on the parameter unit display.

F03 Heatsink OverTmp

The AC drive temperature sensor detects excessive heat. When the Heat Sink temperature has exceeded 95°C, the "F03" fault code will display on the parameter unit display.

F04 Drive Overload

The AC drive detects excessive drive output current. The AC drive can withstand up to 150% of rated current (4.5A) for 1 minute. When this limit has been exceeded, the "F04" fault code will display on the parameter unit display.

F07 Motor Overload

The AC drive detects an excessive motor load. When the value of maximum allowable motor load, which is the setting value of Pr.#99 multiplied by 150% for 1 minute, has been exceeded, the "F07" fault code will display on the parameter unit display.

F13 Ground Fault

The AC drive output is abnormal. When the output terminal is grounded (short circuit current is 50% more than the AC drive rated current), the AC drive power module may be damaged. The short circuit protection is provided for AC drive protection, not user protection.

F14 Under Voltage

The AC drive detects that the DC bus voltage has fallen below its minimum value, 150VAC. When the input voltage has fallen below this value, the "F14" fault code will display on the parameter unit display.

F33 Auto Reset Trials

When the AC drive auto-reset a fault unsuccessfully, the "F33" fault code will display on the parameter unit display.

F100 EEPROM failure

When the internal memory IC cannot be programmed, the "F100" fault code will display on the parameter unit display.

NOTE: All the above Faults are re-settable by change the Value of Parameter 110 to 1 and use the following procedure:

Set Par. 112 for the Number of Retries.

Default Value: 6 Range: 0 → 9 Increment: 1

After fault occurs, the AC drive can be reset/restarted automatically up to 10 times. Setting this parameter to 0 will disable the reset/restart operation after any fault has occurred.

Set Par.113 for the Retry Waiting Time.

Default Value: 2.5 Range: 0 → 120.0 Sec. Increment: 0.1 Sec.

Sets the time **between** restart attempts when Auto Rstrt Tries is set to a value other than zero.

Set Par. 114 for the Retry Selection.

Default Value: 1023 Range: 0 → 1023 Increment: 1

Settings 1: Ground Fault can be auto reset
 2: Over Voltage can be auto reset
 4: Over Current can be auto reset
 8: Low Voltage can be auto reset
 16: Motor Over Load can be auto reset
 32: Drive Over Temperature can be auto reset
 64: Drive Over Load can be auto reset
 128: Current sensor Broken can be auto reset
 256: EEPROM Broken can be auto reset
 512: Software Over Voltage can be auto reset

Example:

If a “Ground Fault”, “Over Current” and “Drive Over Load” needs to be auto reset then Par 114 should be set to 69 (1+4+64). The default value is “1023” which means all faults can be auto reset.

Set Par. 115 for Reset Fault

Default Value: 0 Range: 0 → 2 Increment: 1

Settings 0: Idle State
 1: Resets the active fault but does not clear any fault buffer
 2: Resets the active fault and clears all fault buffers to “0”

Resets a fault and clears the fault buffer. Used primarily to clear a fault over network communications.

7.13 Applications for the heavy input:

The door operator may operate two different hoist-way doors, one door is heavier than the other, in one elevator. As a result, the setting of Torque, and Speed of one door may not be applicable for the other door. More importantly, it may be a code violation issue due to the constraint of the kinetic energy and the Torque allowance. The HEAVY input will resolve this issue. When the HEAVY input is activated, the Drive will operate with a different set of Parameters for the heavier door.

In order to gain the access to the HEAVY set of Parameters, change the value of the Parameter 110 from 0 to 1. The HEAVY set of Parameters is located as follows:

Pr.11 Heavy Door Close Holding Torque

Unit: 0.1 %

Default: 3 %

Range: 0 ~ 30 %

Increase the setting when the motor torque in low speed range is insufficient.

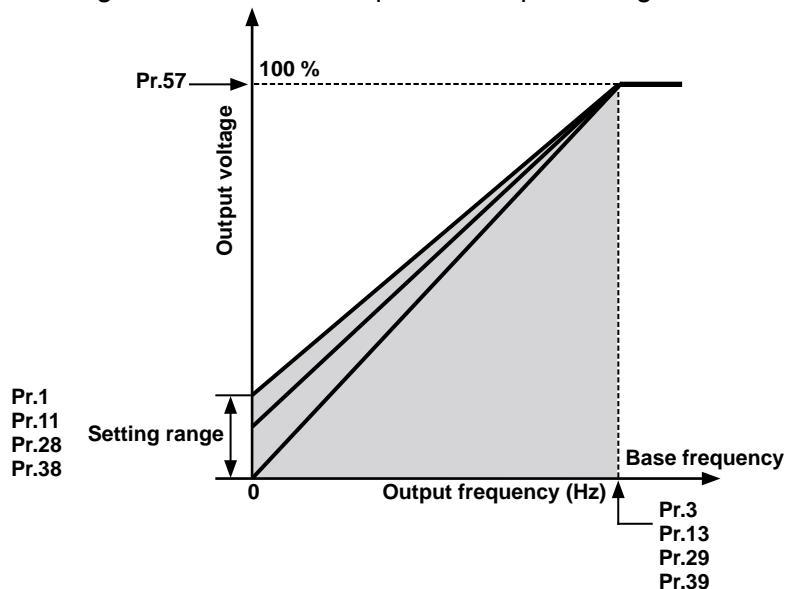

Pr.12 Heavy Door Close Holding Speed

Unit: 0.1 Hz

Default: 2.0 Hz

Range: 0 ~ 400.0 Hz

Pr.13 Heavy Door Close Torque (Base Freq.)

Unit: 0.1 Hz

Default: 173.0 Hz

Range: 0 ~ 400.0 Hz

This parameter is used to adjust the AC drive output (voltage, frequency) to the motor rating.

Pr.14 Heavy Door High Speed Close (HSC)

Unit: 0.1 Hz

Default: 19.0 Hz

Range: 0 ~ 400.0 Hz

Pr.15 Heavy Final Speed Close (FSC)

Unit: 0.1 Hz

Default: 5.0 Hz

Range: 0 ~ 400.0 Hz

Pr.16 Heavy Door Nudging Speed

Unit: 0.1 Hz

Default: 9.0 Hz

Range: 0 ~ 400.0 Hz

Pr.17 Heavy Door Close Acceleration Time

Unit: 0.1 Sec

Default: 6.0

Range: 0 ~ 320.0 Sec

The Acceleration time is used to determine the time required for the AC drive to ramp from 0 Hz to its reference frequency (Pr.50).

Pr.18 Heavy Door Close Deceleration Time

Unit: 0.1 Sec

Default: 10.0

Range: 0 ~ 320.0 Sec

The Deceleration time is used to determine the time required for the AC drive to decelerate from the reference frequency (Pr.50) down to 0 Hz.

Pr.19 Heavy Door Stall Reverse Force (output current detection level)

Unit: (0.1 %)

Default: 1.2A

Range: 0 ~ 200.0 %rated

If the output current remains higher than this setting during AC drive operation, the output current detection signal is on from the open collector output terminal of the AC drive.

Pr.31 Heavy Door Quick Stop on Reverse

Unit: 0.1 A

Default: 2.0A

Range: 0~180 %rated

This parameter determines the level of the DC braking current output to the motor during stopping.

Pr.32 Heavy Door Slow Start Open (SSO)

Unit: 0.1 Hz

Default: 5.0 Hz

Range: 0 ~ 400.0 Hz

Pr.33 Heavy Door High Speed Open (HSO)

Unit: 0.1 Hz

Default: 45.0 Hz

Range: 0 ~ 400.0 Hz

Pr.34 Heavy Door Medium Speed Open (MSO)

Unit: 0.1 Hz

Default: 20.0 Hz

Range: 0 ~ 400.0 Hz

Pr.35 Heavy Door Final Speed Open (FSO)

Unit: 0.1 Hz

Default: 5.0 Hz

Range: 0 ~ 400.0 Hz

Pr.36 Heavy Door Open Acceleration Time

Unit: 0.1 Sec

Default: 4.0 Sec

Range: 0~400.0 Sec

The Acceleration time is used to determine the time required for the AC drive to ramp from 0 Hz to its reference frequency (Pr.50).

Pr.37 Heavy Door Open Deceleration Time

Unit: 0.1 Sec

Default: 10.0 Sec

Range: 0 ~ 400.0 Sec

The Deceleration time is used to determine the time required for the AC drive to decelerate from the reference frequency (Pr.50) down to 0 Hz.

Pr.38 Heavy Door Open Slow Speed Torque

Unit: 0.1 %

Default: 0 %

Range: 0 ~ 30 %

Increase the setting when motor torque in low speed range is insufficient.

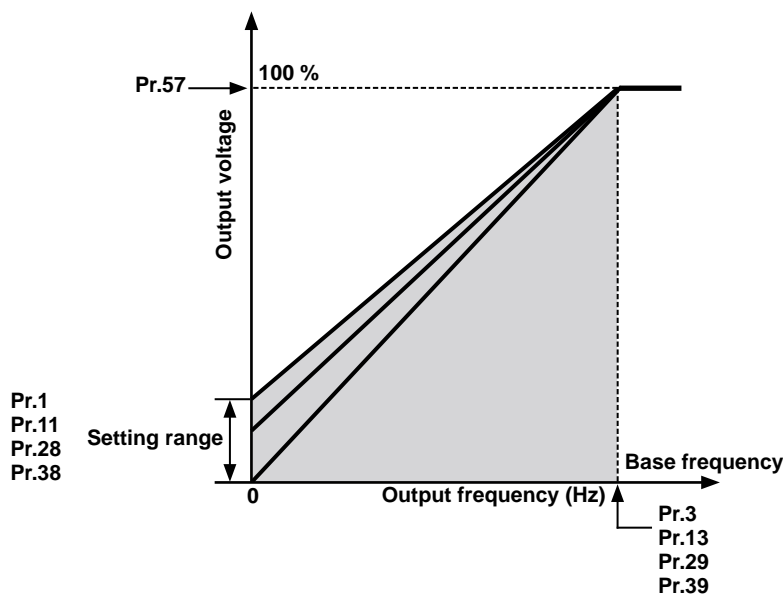

Pr.39 Heavy Door Open Torque (Second V/F (base frequency))

Unit: 0.1 Hz

Default: 80.0 Hz

Range: 0 ~ 400 Hz

Increase the setting when motor torque in low speed range is insufficient.

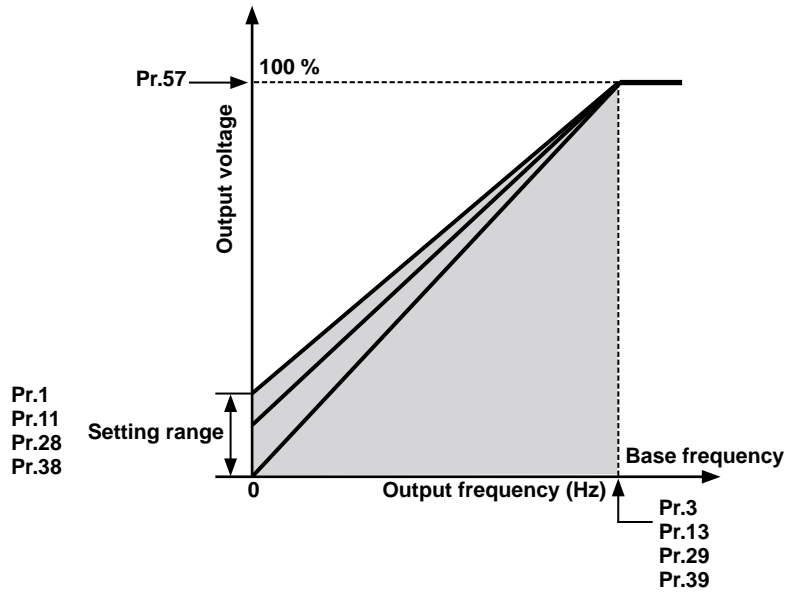

Pr.45 Heavy Door DC Injection Brake Operation Frequency

Unit: 0.1 Hz

Default: 60 Hz

Range: 0 ~ 400.0 Hz

This parameter determines the frequency that the DC braking will begin to output once frequency is reached during deceleration.

Pr.46 Heavy Door DC Injection Brake Operation Time

Unit: 0.1 Sec

Default: 1.0 Sec

Range: 0 ~ 10.0 Sec

This parameter determines the duration that the DC braking current will be applied to the motor during stopping.

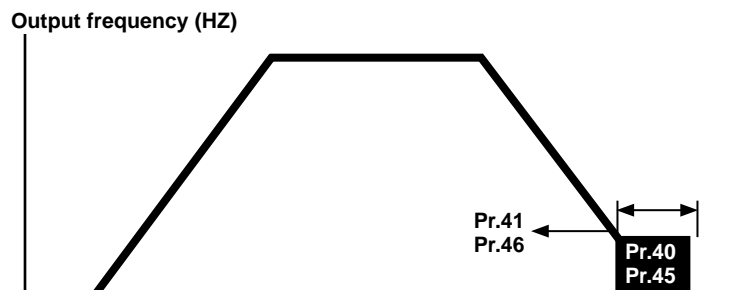

7.14 Parameters list:

- Pr.0 Max. Close Speed (Close Speed detection)
Unit: 0.1 Hz
Default: 30.0 Hz
Range: 0 ~ 400.0 Hz
The output frequency detection signal is on when the output frequency reaches or exceeds the setting value.
- Pr.1 Close Holding Torque (torque boost)
Unit: 0.1 %
Default: 3 %
Range: 0 ~ 30 %
Increase the setting when motor torque in low speed range is insufficient.
- Pr.2 Close Holding Speed
Unit: 0.1 Hz
Default: 2.0 Hz
Range: 0 ~ 400.0 Hz
- Pr.3 Close Torque (Base Freq.)
Unit: 0.1 Hz
Default: 173.0 Hz
Range: 0 ~ 400.0 Hz
This parameter is used to adjust the AC drive output (voltage, frequency) to the motor rating.
- Pr.4 High Speed Close (HSC)
Unit: 0.1 Hz
Default: 19.0 Hz
Range: 0 ~ 400.0 Hz
- Pr.5 Final Speed Close (FSC)
Unit: 0.1 Hz
Default: 5.0 Hz
Range: 0 ~ 400.0 Hz
- Pr.6 Nudging Speed
Unit: 0.1 Hz
Default: 9.0 Hz
Range: 0 ~ 400.0 Hz
- Pr.7 Close Acceleration Time
Unit: 0.1 Sec
Default: 6.0
Range: 0 ~ 320.0 Sec
The Acceleration time is used to determine the time required for the AC drive to ramp from 0 Hz to its reference frequency (Pr.50).

Pr.8 Close Deceleration Time

Unit: 0.1 Sec

Default: 10.0

Range: 0 ~ 320.0 Sec

The Deceleration time is used to determine the time required for the AC drive to decelerate from the reference frequency (Pr.50) down to 0 Hz.

Pr.9 Stall Reverse Force (output current detection level)

Unit: (0.1 %)

Default: 1.2A

Range: 0 ~ 200.0 %rated

If the output current remains higher than this setting during AC drive operation, the output current detection signal is on from the open collector output terminal of the AC drive.

Pr.11 Heavy Door Close Holding Torque

Unit: 0.1 %

Default: 3 %

Range: 0 ~ 30 %

Increase the setting when the motor torque in low speed range is insufficient.

Pr.12 Heavy Door Close Holding Speed

Unit: 0.1 Hz

Default: 2.0 Hz

Range: 0 ~ 400.0 Hz

Pr.13 Heavy Door Close Torque (Base Freq.)

Unit: 0.1 Hz

Default: 173.0 Hz

Range: 0 ~ 400.0 Hz

This parameter is used to adjust the AC drive output (voltage, frequency) to the motor rating.

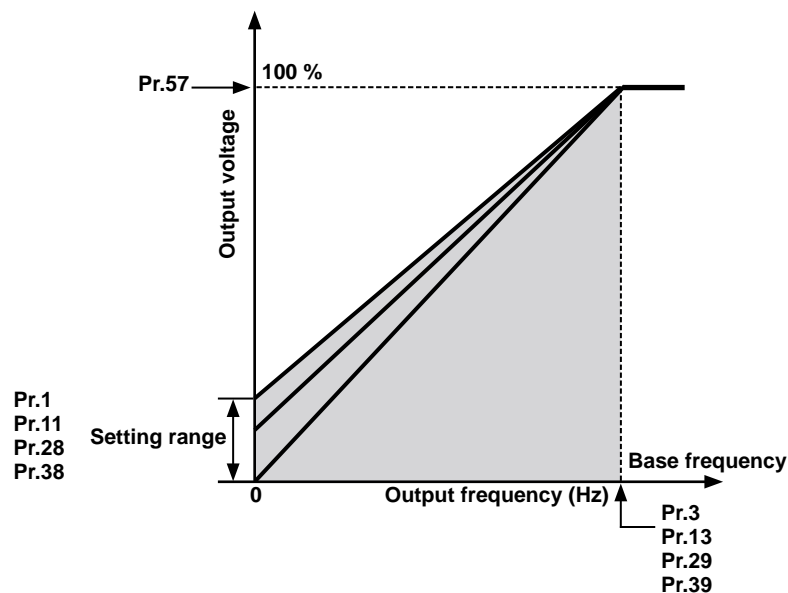

Pr.14 Heavy Door High Speed Close (HSC)

Unit: 0.1 Hz

Default: 19.0 Hz

Range: 0 ~ 400.0 Hz

Pr.15 Final Speed Close (FSC)

Unit: 0.1 Hz

Default: 5.0 Hz

Range: 0 ~ 400.0 Hz

Pr.16 Heavy Door Nudging Speed

Unit: 0.1 Hz

Default: 9.0 Hz

Range: 0 ~ 400.0 Hz

Pr.17 Heavy Door Close Acceleration Time

Unit: 0.1 Sec

Default: 6.0

Range: 0 ~ 320.0 Sec

The Acceleration time is used to determine the time required for the AC drive to ramp from 0 Hz to its reference frequency (Pr.50).

Pr.18 Heavy Door Close Deceleration Time

Unit: 0.1 Sec

Default: 10.0

Range: 0 ~ 320.0 Sec

The Deceleration time is used to determine the time required for the AC drive to decelerate from the reference frequency (Pr.50) down to 0 Hz.

Pr.19 Heavy Door Stall Reverse Force (output current detection level)

Unit: (0.1 %)

Default: 1.2A

Range: 0 ~ 200.0 %rated

If the output current remains higher than this setting during AC drive operation, the output current detection signal is on from the open collector output terminal of the AC drive.

Pr.20 Open Speed detection

Unit: 0.1 Hz

Default: 30.0 Hz

Range: 0 ~ 400.0 Hz

The output frequency detection signal is on when the output frequency reaches or exceeds the setting value.

Pr.21 Quick Stop on Reverse

Unit: 0.1 A

Default: 2.0A

Range: 0~180 %rated

This parameter determines the level of the DC braking Current output to the motor during stopping.

Pr.22 Slow Start Open (SSO)

Unit: 0.1 Hz
 Default: 5.0 Hz
 Range: 0 ~ 400.0 Hz

Pr.23 High Speed Open (HSO)

Unit: 0.1 Hz
 Default: 45.0 Hz
 Range: 0 ~ 400.0 Hz

Pr.24 Medium Speed Open (MSO)

Unit: 0.1 Hz
 Default: 20.0 Hz
 Range: 0 ~ 400.0 Hz

Pr.25 Final Speed Open (FSO)

Unit: 0.1 Hz
 Default: 5.0 Hz
 Range: 0 ~ 400.0 Hz

Pr.26 Open Acceleration Time

Unit: 0.1 Sec
 Default: 4.0 Sec
 Range: 0~400.0 Sec

The Acceleration time is used to determine the time required for the AC drive to ramp from 0 Hz to its reference frequency (Pr.50).

Pr.27 Open Deceleration Time

Unit: 0.1 Sec
 Default: 10.0 Sec
 Range: 0 ~ 400.0 Sec

The Deceleration time is used to determine the time required for the AC drive to decelerate from the reference frequency (Pr.50) down to 0 Hz.

Pr.28 Open Slow Speed Torque

Unit: 0.1 %
 Default: 0 %
 Range: 0 ~ 30 %

Increase the setting when motor torque in low speed range is insufficient.

Pr.29 Open Torque (Second V/F (base frequency))

Unit: 0.1 Hz
 Default: 80.0 Hz
 Range: 0 ~ 400 Hz

Increase the setting when motor torque in low speed range is insufficient.

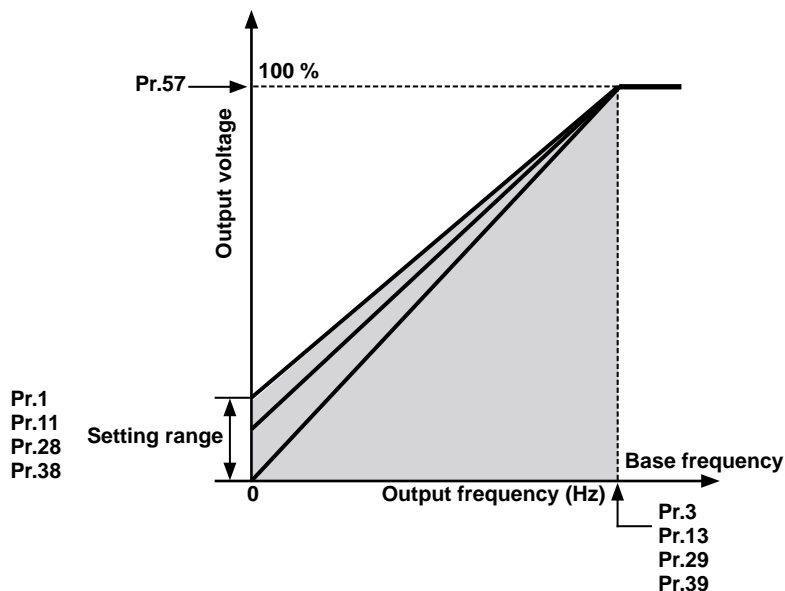

Pr.31 Heavy Door Quick Stop on Reverse

Unit: 0.1 A

Default: 2.0A

Range: 0~180 %rated

This parameter determines the level of the DC braking Current output to the motor during stopping.

Pr.32 Heavy Door Slow Start Open (SSO)

Unit: 0.1 Hz

Default: 5.0 Hz

Range: 0 ~ 400.0 Hz

Pr.33 Heavy Door High Speed Open (HSO)

Unit: 0.1 Hz

Default: 45.0 Hz

Range: 0 ~ 400.0 Hz

Pr.34 Heavy Door Medium Speed Open (MSO)

Unit: 0.1 Hz

Default: 20.0 Hz

Range: 0 ~ 400.0 Hz

Pr.35 Heavy Door Final Speed Open (FSO)

Unit: 0.1 Hz

Default: 5.0 Hz

Range: 0 ~ 400.0 Hz

Pr.36 Heavy Door Open Acceleration Time

Unit: 0.1 Sec

Default: 4.0 Sec

Range: 0~400.0 Sec

The Acceleration time is used to determine the time required for the AC drive to ramp from 0 Hz to its reference frequency (Pr.50).

Pr.37 Heavy Door Open Deceleration Time

Unit: 0.1 Sec

Default: 10.0 Sec

Range: 0 ~ 400.0 Sec

The Deceleration time is used to determine the time required for the AC drive to decelerate from the reference frequency (Pr.50) down to 0 Hz.

Pr.38 Heavy Door Open Slow Speed Torque

Unit: 0.1 %

Default: 0 %

Range: 0 ~ 30 %

Increase the setting when motor torque in low speed range is insufficient.

Pr.39 Heavy Door Open Torque (Second V/F (base frequency))

Unit: 0.1 Hz

Default: 80.0 Hz

Range: 0 ~ 400 Hz

Increase the setting when motor torque in low speed range is insufficient.

Pr.40 DC Injection Brake Operation Frequency

Unit: 0.1 Hz

Default: 60 Hz

Range: 0 ~ 400.0 Hz

This parameter determines the frequency that the DC braking will begin to output once frequency is reached during deceleration.

Pr.41 DC Injection Brake Operation Time

Unit: 0.1 Sec

Default: 1.0 Sec

Range: 0 ~ 10.0 Sec

This parameter determines the duration that the DC braking current will be applied to the motor during stopping.

Pr.45 Heavy Door DC Injection Brake Operation Frequency

Unit: 0.1 Hz

Default: 60 Hz

Range: 0 ~ 400.0 Hz

This parameter determines the frequency that the DC braking will begin to output once frequency is reached during deceleration.

Pr.46 Heavy Door DC Injection Brake Operation Time

Unit: 0.1 Sec

Default: 1.0 Sec

Range: 0 ~ 10.0 Sec

This parameter determines the duration that the DC braking current will be applied to the motor during stopping.

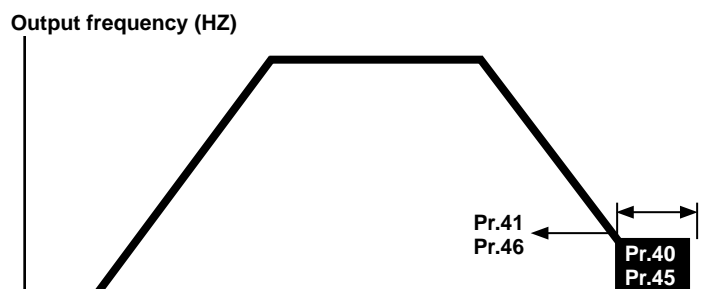

Pr.51 Max. Carrier Frequency
 Carrier frequency for the PWM output waveform
 Unit: 0.1k Hz
 Default: 11.0k Hz
 Range: 2.0 ~ 15.0kHz

This parameter determines the maximum carrier frequency of the AC drive.

Carrier Frequency	Acoustic Noise	Electromagnetic Noise, Leakage Current	Heat Dissipation
2KHz ↑↓ 15KHz	Significant ↑↓ Minimal	Minimal ↑↓ Significant	Minimal ↑↓ Significant

From the table, the PWM carrier frequency has a significant influence on the electromagnetic noise, heat dissipation of the AC drive, and the acoustic noise to the motor.

Pr.67 Door Zone Functionality
 Unit: 1
 Default: 0
 Range: 0 ~ 1
 0: Disable Door Zone Functionality
 1: Enable Door Zone Functionality

Pr.99 Motor Over Load Current
 Unit: 0.1 A
 Default: 2.5 A
 Range: 0 ~ 6 A
 The setting is proportional to the rated current of motor.

Pr.110 User Group Read Selection
 Unit: 1
 Default: 0
 Range: 0 ~ 9999
 When the setting value is 1, user can view and select parameters Pr.0~46, 51, 67, 99, 110 and 112~115. If the setting value is set to any other value (not 1), user can view and select parameters Pr.0~9, 20~29, 51 and 110 only.

Pr.112 Number of Retries
 Unit: 1
 Default: 6
 Range: 0 ~ 9
 After a fault occurs, the AC drive can be reset/restarted automatically up to 10 times. Setting this parameter to 0 will disable the reset/restart operation after any fault has occurred.

Pr.113 Retry Waiting Time

Unit: 0.1 Sec

Default: 2.5 Sec

Range: 0 ~ 120.0 Sec

Sets the time between restart attempts when Auto Restart Tries is set to a value other than zero.

Pr.114 Retry Selection

Unit: 1

Default: 1023

Range: 0 ~ 1023

1: Ground Fault can be auto reset

2: Over Voltage can be auto reset

4: Over Current can be auto reset

8: Low Voltage can be auto reset

16: Motor Over Load can be auto reset

32: Drive Over Temperature can be auto reset

64: Drive Over Load can be auto reset

128: Current sensor Broken can be auto reset

256: EEPROM Broken can be auto reset

512: Software Over Voltage can be auto reset

If a "Ground Fault", "Over Current" and "Drive Over Load" needs to be auto reset then Par114 should be set to 69 (1+4+64). The default value is "1023" which means all faults can be auto reset.

Pr.115 Reset Fault

Unit: 1

Default: 0

Range: 0 ~ 2

0: Idle State

1: Resets the active fault but does not clear any fault buffer

2: Resets the active fault and clears all fault buffers to "0"

Resets a fault and clears the fault buffer. Used primarily to clear a fault over network communications.

7.15 How to replace the drive:

1. Disconnect the door operator power from the machine room
2. Flip ON-OFF switch on operator board to OFF position and the AUTO-MAN switch to the MAN position
Wait 10 minutes for the drive's internal capacitor to completely discharge.
3. Unplug the ribbon cable from the drive.
4. Unplug the green power connector.
5. Remove drive mounting screws.
6. Install the new drive
7. Plug the green power connector
8. Plug the ribbon cable to the drive
9. Reapply power to the drive but leave the switch in the MAN position for now.
10. WRITE the parameters from the parameter unit into the drive as explained in section 7.5
11. Check door operation with the OPEN-CLOSE switch before returning the system to AUTO.

Copyright © 2004, G.A.L. Manufacturing Corporation
All rights reserved.

No part of this document may be reproduced in any form, machine or natural, without the express
written consent of G.A.L Manufacturing Corporation.